

AFL3-W19C-ADLP

IEI Light Industrial Panel PC

Powered by Intel® Alder Lake-P / Raptor Lake-P



www.ieiworld.com



AFL3-W19C-ADLP

Fanless, high-performance Panel PC, supporting 12th/13th Gen Intel® Core™ i7/i5/i3 processors, 8GB DDR4 memory, HDMI output, dual 2.5GbE LANs, IPMI remote management, three M.2 expansion slots, and an anti-glare, UV-resistant, 10-point capacitive touchscreen that is RoHS-compliant

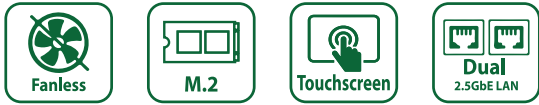

12th/13th Gen Intel® Core™ Mobile Processors

The 12th/13th Generation Intel® Core™ mobile processors feature a new Performance Hybrid Architecture that delivers superior performance and rich scaling for a superior experience.

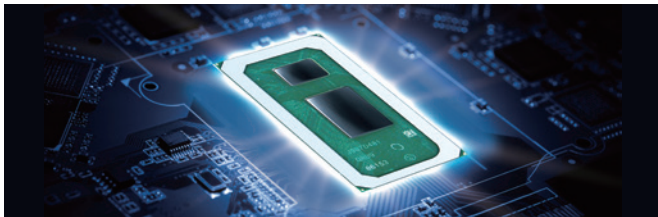

Support 4K UHD Display Output

10th generation Intel® Ultra HD graphics engine allows the system to display video and images in stunning 4K resolution over HDMI 1.4b



Anti-glare and Anti-UV PCAP

With anti-glare and anti-UV coating, the 10-point touch screen can be displayed clearly without reflection.



Support WiFi 6E and Bluetooth 5.2

Strong Wi-Fi 6E wireless network capability provides more bandwidth, and the low latency Bluetooth 5.2 connection is more stable and consumes less power.



IPMI 2.0 Remote Management

Together with the IEI iRIS expansion card, it can support remote management system over the network for OS installation and restoration, power on or power off, and other operations.

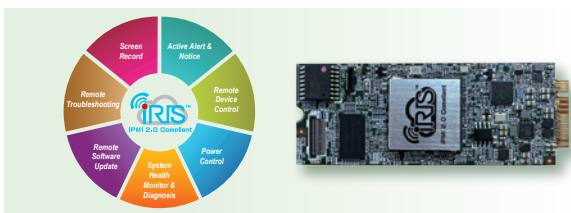

Dual full-speed M.2 expansion slots

Two M.2 M-key slots accept 2280 sizes of M.2 modules, and supports PCIe Gen4 x4 full-speed signal for more bandwidth and faster speed.

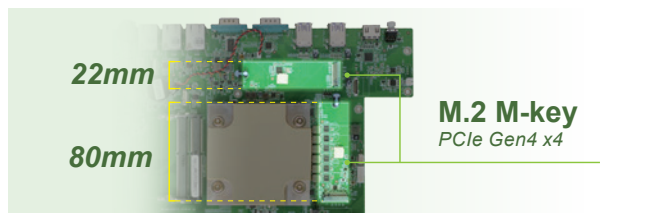

Fully Integrated I/O

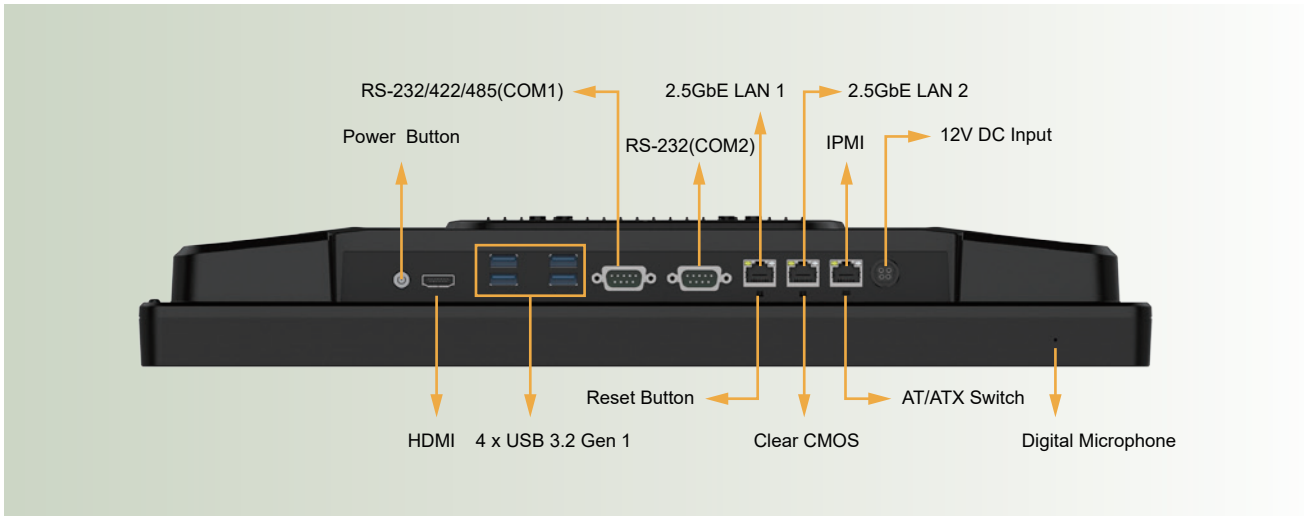

Block Diagram

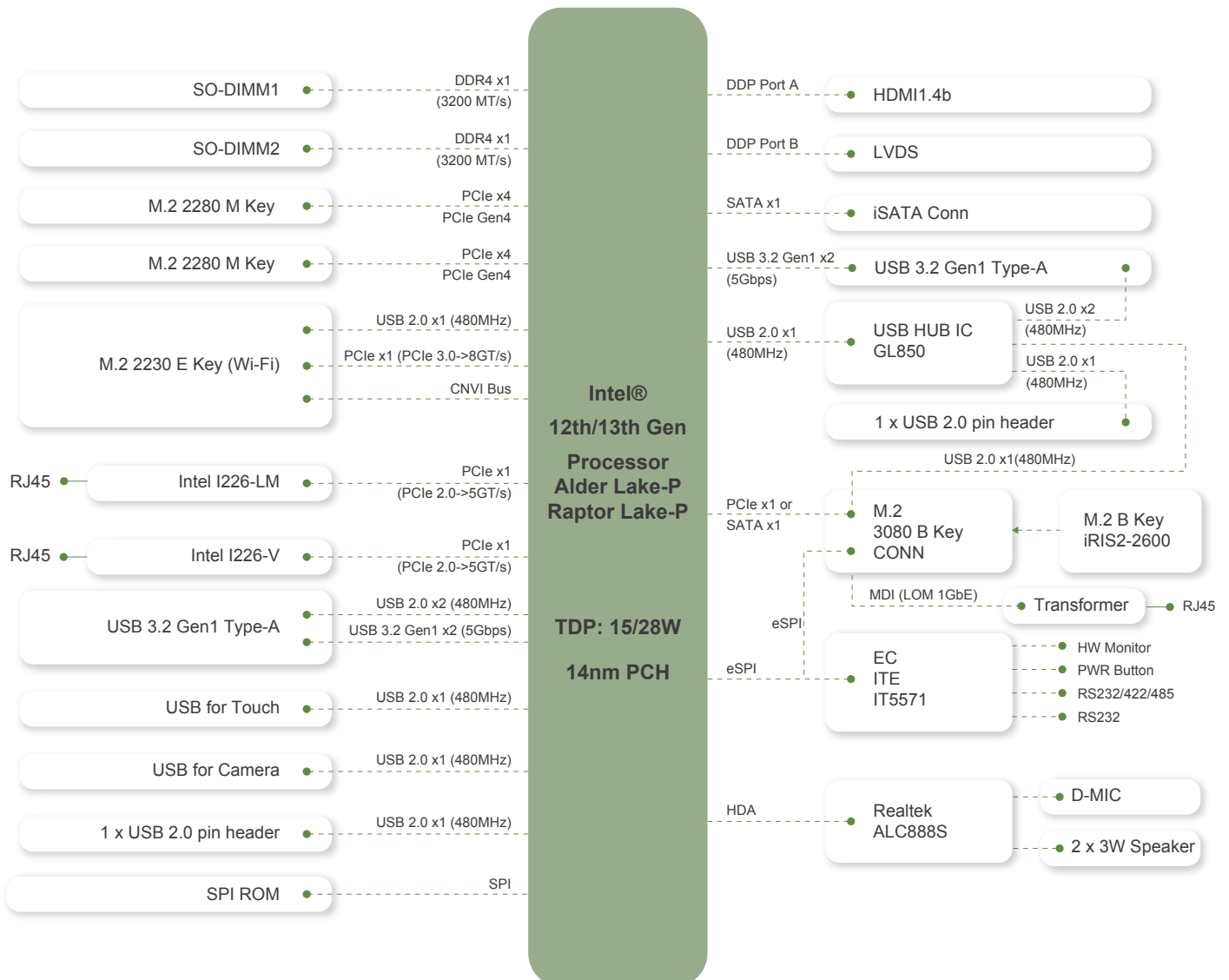

Dimensions (Unit: mm)

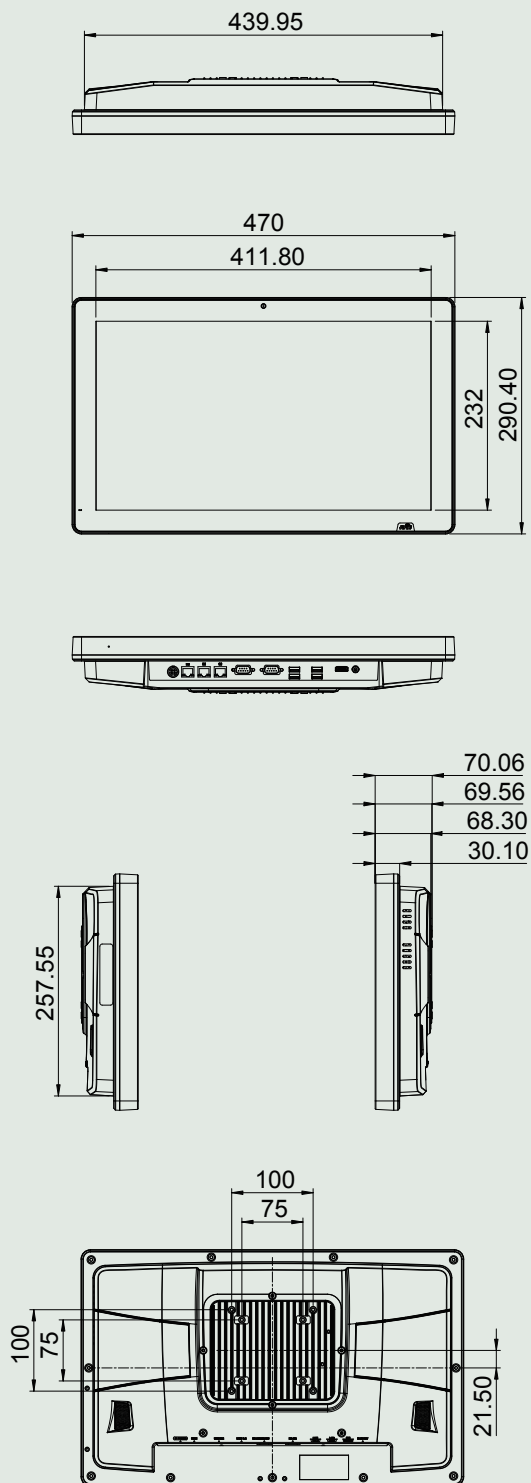

Specifications

Model		AFL3-W19C-ADLP	
LCD	Size	18.5"	
	Resolution	1920 x 1080 (16:9)	
	Brightness (cd/m ²)	350	
	Contrast Ratio	1200:1	
	Viewing Angle (H-V)	170/170	
Touch	Backlight MTBF	50000	
	Touch Screen	PCAP with USB interface (anti-UV/AG coating)	
Mainboard	Touch Controller	EXC3160	
	Ethernet	LAN1: Intel® I226 LM(support Intel AMT) LAN2: Intel® I226V	
	RAM	Two 260-pin 3200 MHz dual-channel DDR4 SO-DIMM (8GB pre-installed) (up to 64GB)	
	SOC	12/13th Gen Intel® Core™ Mobile i7/i5/i3 Processors (Alder Lake-P/Raptor Lake-P)	
	Audio Codec	ALC888S	
	Storage	1 x 2.5" SATA 6Gb/s HDD bay	
	Expansion	2 x M.2 2280 M-key (PCIe Gen4x4) 1 x M.2 3080 B-key (PCIe x1 or SATA) support IPMI function	
	I/O Ports & Switch	1 x RS-232 by DB9 1 x RS-232/422/485 w/ AFC by DB9 2 x 2.5GbE LAN 1 x RJ45 for IPMI 4 x USB 3.2 Gen1	1 x HDMI output 1 x 12V DC jack 1 x Power button 1 x Reset button 1 x Clear CMOS button 1 x AT/ATX switch
	Audio	AMP 3W + 3W (internal speaker)	
	Camera / Microphone	2-megapixel with low light function, digital microphone	
Wireless & Bluetooth	IEEE 802.11ax 2T2R module (Wi-Fi 6E) with BT v5.2 (M.2 2230 E-key)		
Physical	Construction Front Panel	PC + ABS Plastic	
	Mounting	VESA 75 /100mm	
	Color	Black C	
Environment	Operating Temperature (°C) (Ambient with air flow)	0 ~ 50	
	Storage Temperature (°C)	-20 ~ 60	
	Humidity	10 ~ 90RH@40°C (non-condensing)	
	IP Level	IP 64 compliant front panel	
	Safety&EMC	CE, FCC (Class A), UKCA	
Power	Terminal	Fanless	
	Power Requirement	12V DC	
	Power Consumption	12V@7.1A (Intel® Core i7-1270PE With 8GB DDR4 Memory)	
ErP	ErP 2009/125/EC		
Supported OS	Microsoft Windows® 10/11 IoT, Linux		
Dimensions	469.6 x 289.6 x 70.0 (mm)		
Net Weight	6.79kg		

Packing List

1 x Power cord	1 x Screw	1 x Power adapter	1 x QIG
----------------	-----------	-------------------	---------

Odering Information

Part.No	Description
AFL3-W19C-ADLP-Ri3E/8G-R11	Wide 18.5" 350cd/m ² 1920x1080 Panel PC with 13th Generation Intel® Core™ i3-1320PE on-board processor, PCAP touch, 2M camera, microphone, 1x8GB DDR4 RAM, with AG, RoHS
AFL3-W19C-ADLP-Ri5E/8G-R11	Wide 18.5" 350cd/m ² 1920x1080 Panel PC with 13th Generation Intel® Core™ i5-1340PE on-board processor, PCAP touch, 2M camera, microphone, 1x8GB DDR4 RAM, with AG, RoHS
AFL3-W19C-ADLP-Ri7E/8G-R11	Wide 18.5" 350cd/m ² 1920x1080 Panel PC with 13th Generation Intel® Core™ i7-1370PE on-board processor, PCAP touch, 2M camera, microphone, 1x8GB DDR4 RAM, with AG, RoHS

Options

Item	Part No
Wall Mounting Kit	AFLWK-19B
Arm	ARM-11-RS
Stand	STAND-A21-R10/ STAND-210-R11/STAND-C19-R10
IPMI card	iRIS2-2600-R10/iRIS2-2620-R10