

MPT-7100R

Railway Computer System with WWAN Redundancy

User Manual

Version 1.0
June 2025



Copyright

© 2025 IBASE Technology, Inc. All rights reserved.

No part of this publication may be reproduced, copied, stored in a retrieval system, translated into any language, or transmitted in any form or by any means, electronic, mechanical, photocopying, or otherwise, without the prior written consent of IBASE Technology, Inc. (hereinafter referred to as "IBASE").

Disclaimer

IBASE reserves the right to make changes and improvements to the products described in this document without prior notice. Every effort has been made to ensure the information in the document is correct; however, IBASE does not guarantee this document is error-free. IBASE assumes no liability for incidental or consequential damages resulting from misapplication or inability to use the product or the information contained herein, nor for any infringements of rights of third parties, which may result from its use.

Trademarks

All the trademarks, registrations, and brands mentioned herein are used for identification purposes only and may be trademarks and/or registered trademarks of their respective owners.

Compliance

CE

This product has passed CE tests for environmental specifications and limits. This product is in accordance with the directives of the European Union (EU). If users modify and/or install other devices in this equipment, the CE conformity declaration may no longer apply.

FCC

This product has been tested and found to comply with the limits for a Class B device, pursuant to Part 15 of the FCC Rules. These limits are designed to provide reasonable protection against harmful interference in a residential installation. This equipment generates, uses and can radiate radio frequency energy and, if not installed and used in accordance with manufacturer's instructions, may cause harmful interference to radio communications.

WEEE



This product must not be disposed of as normal household waste, in accordance with the EU directive of for Waste Electrical and Electronic Equipment (WEEE – 2012/19/EU). Instead, it should be disposed of by returning it to a municipal recycling collection point. Check local regulations for disposal of electronic products.

Green IBASE



This product is compliant with the current RoHS 2 restrictions and prohibits use of the following substances in concentrations exceeding 0.1% by weight (1000 ppm) except for cadmium, limited to 0.01% by weight (100 ppm).

- Hexavalent chromium: 1,000 ppm
- Poly-brominated biphenyls (PBBs): 1,000 ppm
- Poly-brominated diphenyl ethers (PBDEs): 1,000 ppm
- Cadmium: 100 ppm
- Mercury: 1,000 ppm
- Lead: 1,000 ppm
- Bis(2-ethylhexyl) phthalate (DEHP): 1,000 ppm
- Butyl benzyl phthalate (BBP): 1,000 ppm
- Dibutyl phthalate (DBP): 1,000 ppm
- Diisobutyl phthalate (DIBP): 1,000 ppm

Important Safety Information

Carefully read the precautions before using the device.

Environmental conditions:

- Lay the device horizontally on a stable and solid surface in case the device may fall, causing serious damage.
- Leave plenty of space around the device and do not block the openings for ventilation. Never drop or insert any objects of any kind into the ventilation openings.
- Slots and openings on the chassis are for ventilation. Do not block or cover these openings. Make sure you leave plenty of space around the device for ventilation. Never insert objects of any kind into the ventilation openings.

Care for your iBASE products:

- Before cleaning the device, turn it off and unplug all cables such as power in case a small amount of electrical current may still flow.
- Use neutral cleaning agents or diluted alcohol to clean the device chassis with a cloth. Then wipe the chassis with a dry cloth.
- Vacuum the dust with a computer vacuum cleaner to prevent the air vent or slots from being clogged.



WARNING

Attention during use:

- Do not use this product near water.
- Do not spill water or any other liquids on your device.
- Do not place heavy objects on the top of the device.
- Operate this device from the type of power indicated on the marking label. If you are not sure of the type of power available, consult your distributor or local power company.
- Do not walk on the power cord or allow anything to rest on it.
- If you use an extension cord, make sure that the total ampere rating of the product plugged into the extension cord does not exceed its limits.

Avoid Disassembly

You are not suggested to disassemble, repair or make any modification to the device. Disassembly, modification, or any attempt at repair could generate hazards and cause damage to the device, even bodily injury or property damage, and will void any warranty.



CAUTION

Danger of explosion if the internal lithium-ion battery is replaced with an incorrect type. Replace only with the same or an equivalent type recommended by the manufacturer. Dispose of used batteries according to the manufacturer's instructions.

Warranty Policy

- **IBASE standard products:**

24-month (2-year) warranty from the date of shipment. If the date of shipment cannot be ascertained, the product serial numbers can be used to determine the approximate shipping date.

- **3rd-party parts:**

12-month (1-year) warranty from delivery for the 3rd-party parts that are not manufactured by IBASE, such as CPU, memory, SSD/HDD, power adapter, panel and touchscreen.

* *Products that fails due to misuse, accident, improper installation or unauthorized repair shall be treated as out of warranty and customers shall be billed for repair and shipping charges.*

Technical Support & Services

1. Visit the IBASE website at www.ibase.com.tw to find the latest information about the product.
2. If you need any further assistance from your distributor or sales representative, prepare the following information of your product and elaborate upon the problem.
 - Product model name
 - Product serial number
 - Detailed description of the problem
 - The error messages in text or in screenshots if there is any
 - The arrangement of the peripherals
 - Software in use (such as OS and application software, including the version numbers)
3. If repair service is required, you can download the RMA form at the website of IBASE. Fill out the form and contact your distributor or sales representative.

Table of Contents

Chapter 1	General Information	1
1.1	Introduction	2
1.2	Features.....	3
1.3	Packing List	3
1.4	Optional Accessories	3
1.5	Specifications.....	4
1.6	System View	6
1.7	System Dimensions	8
1.8	Board View	9
1.9	MBT-7101 Board Dimensions	10
Chapter 2	Hardware Configuration	11
2.1	Essential Installations.....	12
2.1.1	Memory Installation	13
2.1.2	Storage Installation.....	14
2.1.3	Mounting Brackets Installation	17
2.1.4	Pinout for COM Ports, Power Input & GPIO Connectors.....	18
2.2	Jumper & Connector Locations on Motherboard	22
2.3	Jumpers Quick Reference.....	24
2.4.1	JP1: COM1 RS232 RI/+5V/+12V Power Setting	24
2.4.2	JP2: ATX / AT Mode Setting.....	25
2.4.3	J3: Flash Descriptor Security Override	26
2.4.4	JP4: Clear CMOS Contents	27
2.4.5	JP5: Clear ME Contents	28
2.4.6	JP6: SIM Card Select (for CN14 SIM2).....	29
2.4.7	JP7: M.2 B-key Sierra EM9191 USB/PCIE Select	30
2.4	Connectors on MBT-7101	31
2.5.1	PCIE1: PCIEx4 Slot.....	33
2.5.2	PCIE2: DC_in Connector (+12V)	33
2.5.3	SW1_1: COM3 RS-485 Terminal Register.....	34
2.5.4	SW1_2: COM4 RS-485 Terminal Register.....	34
2.5.5	SW2: Digital IO Pull High to +5V Switch	35
2.5.6	SW3: Reset Button	36
2.5.7	J21: COM3 / COM4 RS485 Connector	37
2.5.8	CN1: COM1 RS232/422/485 Port.....	38

*COM1 setting is selectable in BIOS.....	38
2.5.9 CN2: DisplayPort connector.....	39
2.5.10 CN3: DVI-D Connector.....	39
2.5.11 CN4, CN5: 2.5G LAN Connectors (option).....	40
2.5.12 J2, J3: 2.5G LAN Pin Header.....	40
2.5.13 CN6, CN7: SATA2 Connector.....	41
2.5.14 CN8: +12V Connector.....	41
2.5.15 CN9: Digital I/O Connector.....	42
2.5.16 CN10, CN11: Audio (Front) Connector.....	42
2.5.17 J24: Audio Pin Header.....	43
2.5.18 CN12: Dual USB 3.0 Connector.....	44
2.5.19 CN13: SIM (J19-1) Connector.....	44
2.5.20 CN14: SIM2 (J14, J19-2) Connector.....	44
2.5.21 CN15: Type-C Connector for 5,9.15.20V Power Out USB3.DP ...	45
2.5.22 VGA1: CRT Connector.....	46
2.5.23 J1: CAN Port Connector.....	47
2.5.24 J4: COM2 RS232 Connector.....	48
2.5.25 J5: USB 2.0 x2 Pin Header.....	49
2.5.26 J6, J7: SATA HDD Power Connectors.....	50
2.5.27 J8: M.2(M) 2080 PCIE X4 Connector.....	50
2.5.28 J10: Debug Port.....	51
2.5.29 J11: DDR5 SO-DIMM (CH-A) Sockets.....	51
2.5.30 J12: DDR5 SO-DIMM (CH-B) Sockets.....	52
2.5.31 J13: Half-sized Mini PCIE (USB2.0) Connector.....	52
2.5.32 J14: Full-sized Mini PCIE (USB2.0/ PCIe x1) Connector.....	53
2.5.33 J15: Signals for the Power Board.....	53
2.5.34 J16: Battery Connector.....	54
2.5.35 J17: M.2(E) 2230 (USB2.0/ PCIe x1) Connector.....	54
2.5.36 J18: SPI Flash Connector (Factory use only).....	55
2.5.37 J19: M.2(B) 3042/52 Connector (PCIE x1 / USB 3.0).....	55
2.5.38 J20: Power Button Pin Header.....	56
2.5.39 LED1, LED2, LED3, LED4, LED5, LED6.....	56
2.5.40 LED7, LED8, LED9, LED10.....	57
Chapter 3 Driver Installation.....	58
Chapter 4 BIOS Setup.....	68
Appendix.....	93
A. I/O Port Address Map.....	94
B. Interrupt Request Lines (IRQ).....	94
C. Watchdog Timer Configuration.....	95

Chapter 1

General Information

The information provided in this chapter includes:

- Features
- Packing List
- Specifications
- Product View
- Dimensions

1.1 Introduction

The MPT-7100R is a rugged, fanless in-vehicle computer system built for demanding mobile applications, certified to EN50155 (2021) and EN45545-2 standards. It features robust M12 connectors, dual SIM sockets for WWAN redundancy, and an onboard isolated CAN 2.0A/2.0B/CAN-FD interface. The system supports dual removable 2.5" SSDs, USB Type-C with 60W PD, and a wide array of I/O for wireless, GPS, GPIO, and expansion cards. With ignition power control and a wide voltage GPIO interface, the MPT-7100R is ideal for reliable and connected in-vehicle computing.



1.2 Features

- EN50155 (2021) / EN45545-2 certified
- Fanless and ruggedized design
- Robust M12 connectors for dual GbE, USB and power input
- Dual SIM sockets support WWAN redundancy
- Onboard isolated CAN 2.0A / 2.0B / CAN-FD
- Two removable 2.5" device bay for SSD storage
- Rich I/O for wireless, SSD, GPS, WWAN and add-on card expansion
- Ignition power control
- Wide-range voltage GPIO interface
- 1x USB Type-C alternate mode with PD 60W

1.3 Packing List

Your MPT-7100R package should include the items listed below.

Item	Q'ty	IBASE P/N
MPT-7100R	1	--
Manual @ Driver download instruction		D2MANUAL--0000100P
Wall Mounting Bracket	2	H06MTMPT7100V000AP
GPIO Matching Connector (Dinkle terminal block, 10 pins)	1	C1216ECH311003100P
CAN BUS Matching Connector (Dinkle terminal block, 6 pins)	1	C1216ECH306103100P
Wall Mounting Bracket Screw	4	H02306110122001N0P

1.4 Optional Accessories

Item	IBASE P/N
Power cable: M12 A-Code to bare wired	C501PW39904121000P
LAN cable: M12 X-Code to RJ45 CAT-6 (up to 2.5GbE)	C501LAN8208A32000P
LAN cable: M12 X-Code to RJ45 CAT-5 (up to 1.0GbE)	C501LAN6300A32000P
USB cable: M12 A-code to USB Type-A	C501USB1320A32000P
Fuse	C2309000801250100P

1.5 Specifications

Product Name	MPT-7100R
Models	
MPT-7100R	MPT-7100R with MBT-7101R, 13th Gen Intel® Core™ i7 1365URE Processor w/ 2x 8GB DDR5-5200, 2x SSD bay, No PSU, No storage (RoHS) 24V DC-in
MPT-7100RH	MPT-7100R with MBT-7101R, 13th Gen Intel® Core™ i7 1365URE Processor w/ 2x 8GB DDR5-5200, 2x SSD bay, No PSU, No storage (RoHS) 48/72/110V DC-in
System	
Motherboard	MBT-7101
CPU	13th Gen Intel® Core U-Series Processor
Speed	Up to 3.0GHz
Memory	2x 8GB DDR5-5200 SO-DIMM (Dual Channel)
Front Panel External I/O	<ul style="list-style-type: none"> • 2x USB3.2 Gen2 stack Type-A connector • 2x External accessible SIM socket • 1x USB Type-C connector with screw-lock • 2x Removable 2.5" SSD device bay • 1x 3.5mm green color audio for Line-out • 1x 3.5mm pink color audio for MIC-in 1x Reset button • 1x 10-pin terminal block for isolated digital I/O 8x SMA antenna holes • 6x Light-pipe for status LED indicators (2x programmable)
Rear Panel External I/O	<ul style="list-style-type: none"> • 2x M12 X-code 8P female for GbE LAN1/LAN2 • 1x M12 A-code 4P male for DC-input • 2x M12 A-code 4P female for USB 2.0 • 1x DisplayPort output • 1x DVI-D connector, 1x VGA connector • 1x 6-pin terminal block for 2x isolated CAN bus • 2x DB9M for COM#1 (RS232/422/485) / COM#2 (RS232 only) • 1x Removable blade fuse holder • 4x Light-pipe for LAN status LED indicators • 1x PCI-E (x4) slot • 1x M3 with washer screw hole for grounding connection
Storage	<ul style="list-style-type: none"> • 1x M.2 2280 M-Key socket for NVMe SSD (PCI-E x4 [Gen.4]) • 2x 2.5" removable device bay for SSD

Expansion slots	<ul style="list-style-type: none"> • 1x M.2 2230 E-Key socket for WLAN & BT connection (PCI-E + USB2.0 + SMBus). • 1x M.2 3042/52 B-Key socket for WWAN (4G/5G) connection (PCI-E + USB3.2 + SMBus) • 1x M.2 2280 M-Key socket for NVMe SSD / Hailo AI module (PCI-E x4 [Gen.4]) • 1x Mini PCI-E full-size socket for MVB/CAN FD module (PCI-E + USB2.0 + SMBus) • 1x Mini PCI-E half-size socket (USB 2.0)
Power Supply	DC-input for 24V~110V
Construction	Aluminum
Chassis Color	Silver & Blue
Mounting	Wall mounting
Dimensions	256.0 (W) x 182.0 (D) x 97.3 (H) mm 10.08" (W) x 7.17" (D) x 3.83" (H)
Environmental	
Operating Temperature	-40°C ~70°C (-40°F~158°F) (w/o FAN & SSD), up to 85°C for 10 minutes according to EN 50155 OT4 -20°C ~55°C (-4°F~131°F) (w/ PCI-E card)
Storage Temperature	-40°C ~ 85°C (-40°F~185°F)
Relative Humidity	10 ~ 95% RH @45°C (non-condensing)
Vibration	Function: 1 m/s ² , 5Hz~150 Hz (EN 61373) Lifetime: 7.9 m/s ² , 5Hz~150 Hz (EN 61373)
Shock	50 m/s ² , 30 msec (EN 61373)

All specifications are subject to change without prior notice.

1.6 System View

Front View

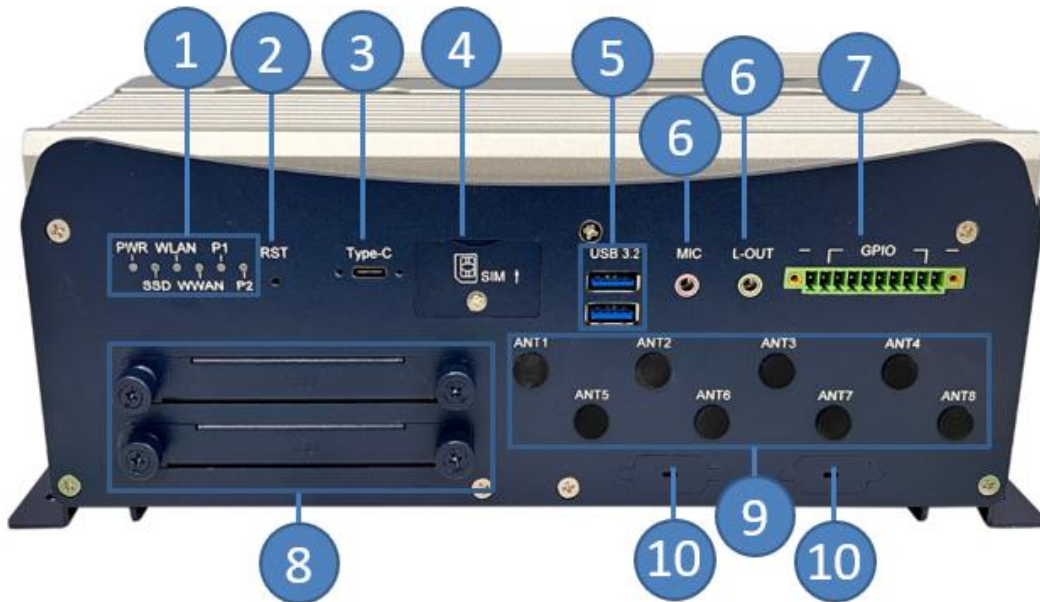

No.	Name	No.	Name
1	LED for PWR, SSD, WLAN, WWAN, P1 & P2	6	Microphone and Line-Out
2	Reset Button	7	GPIO Connector
3	USB Type-C Connector	8	Removable SSD Drive Bays
4	Dual SIM Card Socket	9	Antenna Holes
5	USB 3.2 Connectors	10	Reserved Space for DB9

Rear View

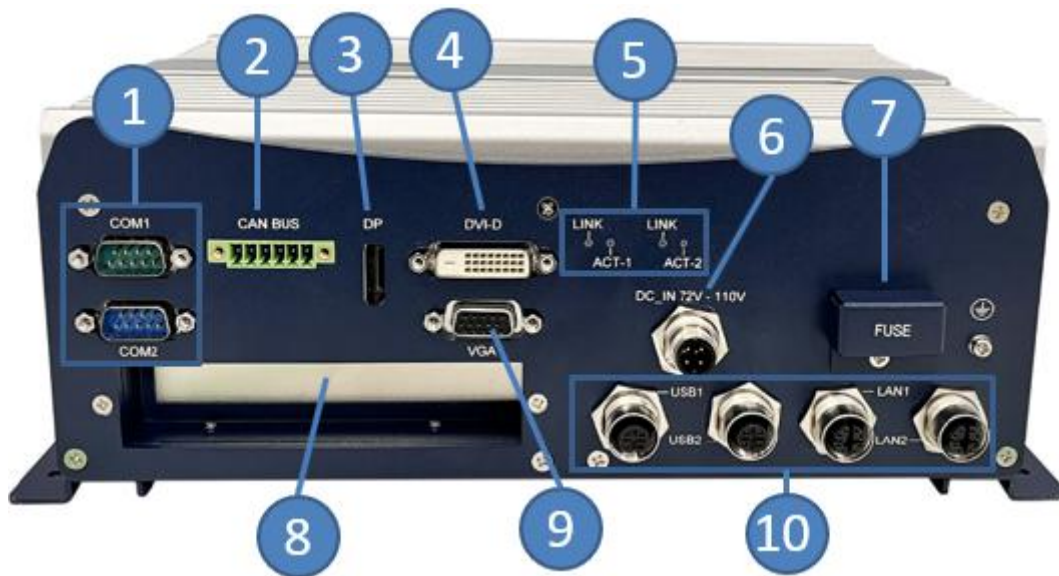

No.	Name	No.	Name
1	COM1 & COM2 Connector	6	DC Power Input (M12)
2	CANBUS	7	Fuse holder
3	DisplayPort	8	PCI-E (x4) slot
4	DVI-D Connector	9	VGA Connector
5	LED Indicators for LAN Ports	10	USB 2.0 and LAN in (M12)

Remarks: DC_IN is available in 24V for the **MPT-7100R** model and 72V~110V for the **MPT-7100RH** model.

1.7 System Dimensions

Unit: mm

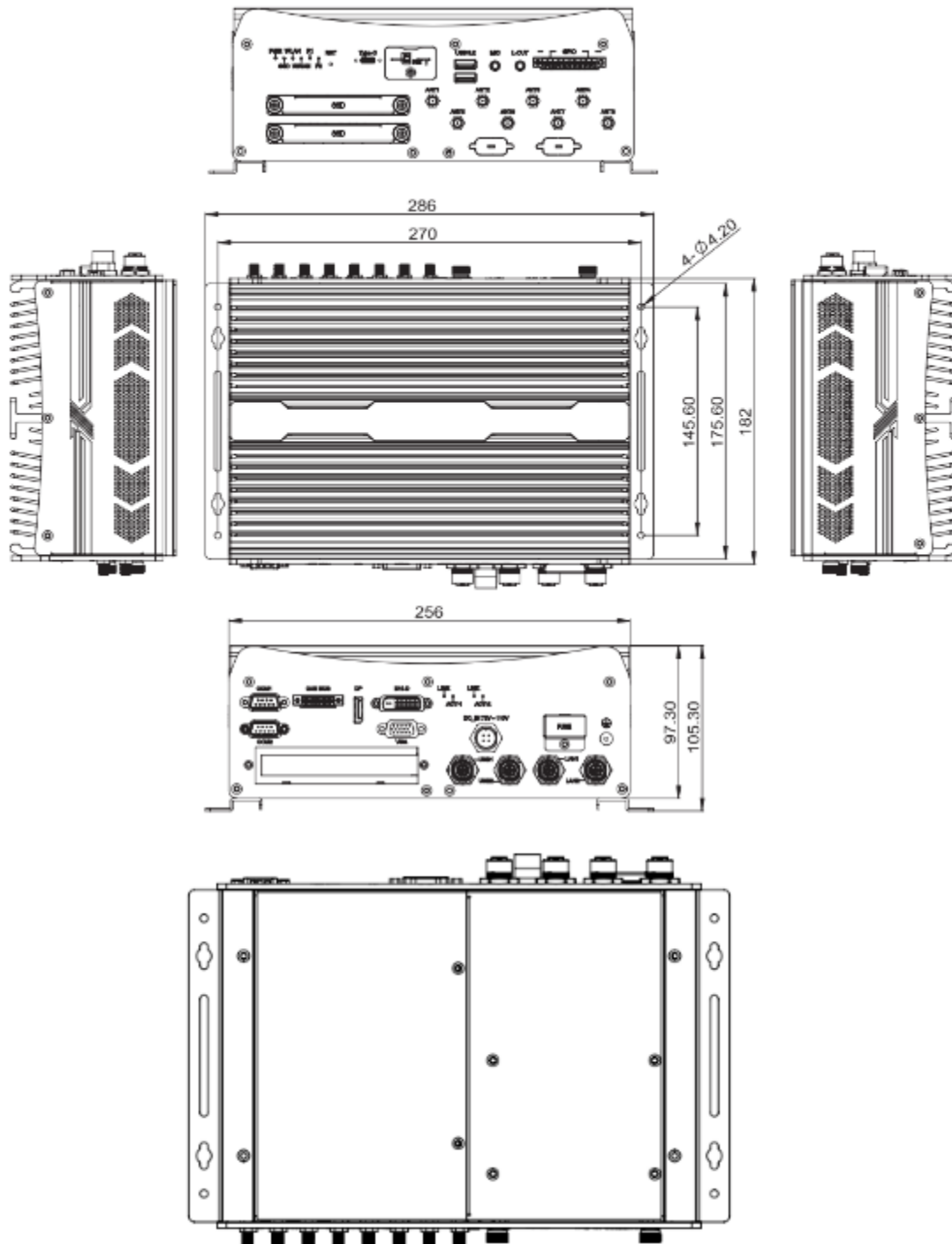

1.8 Board View

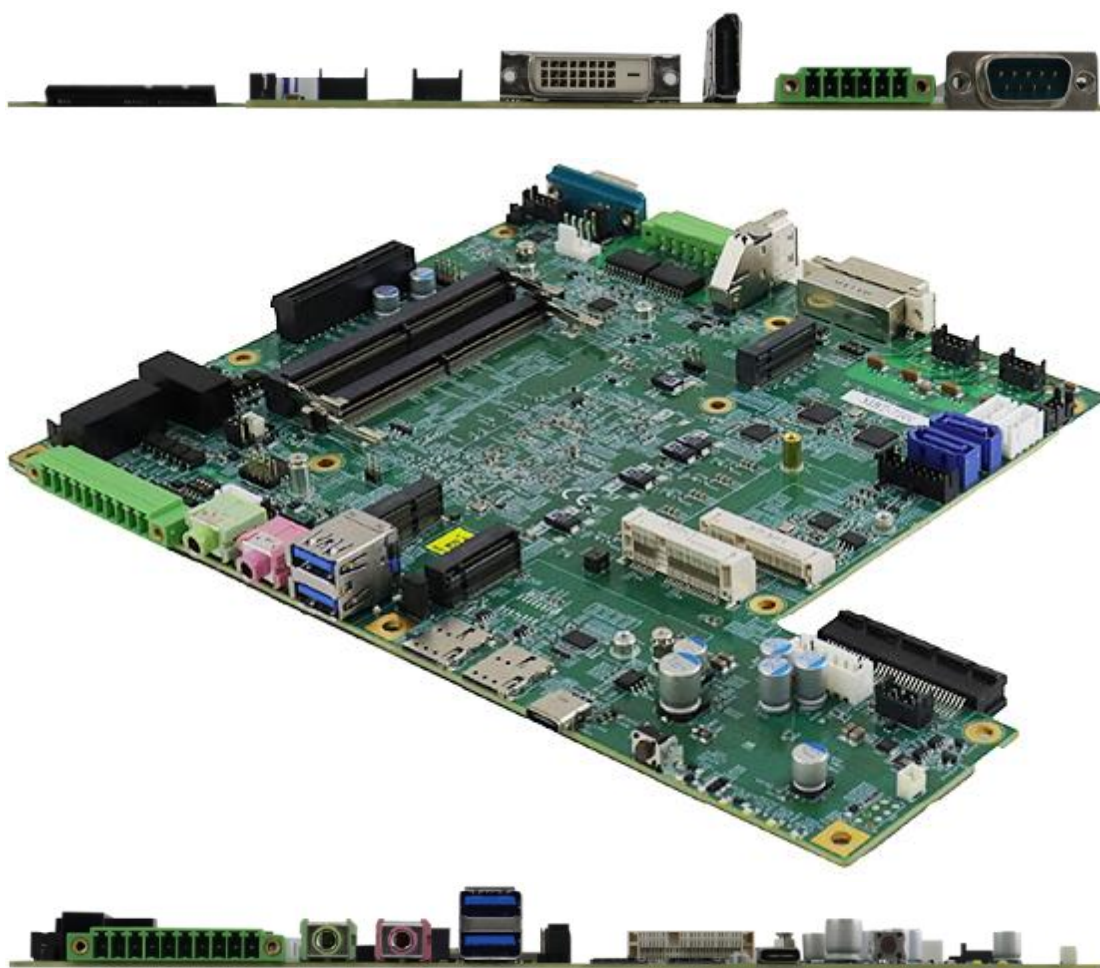

1.9 MBT-7101 Board Dimensions

Unit: mm

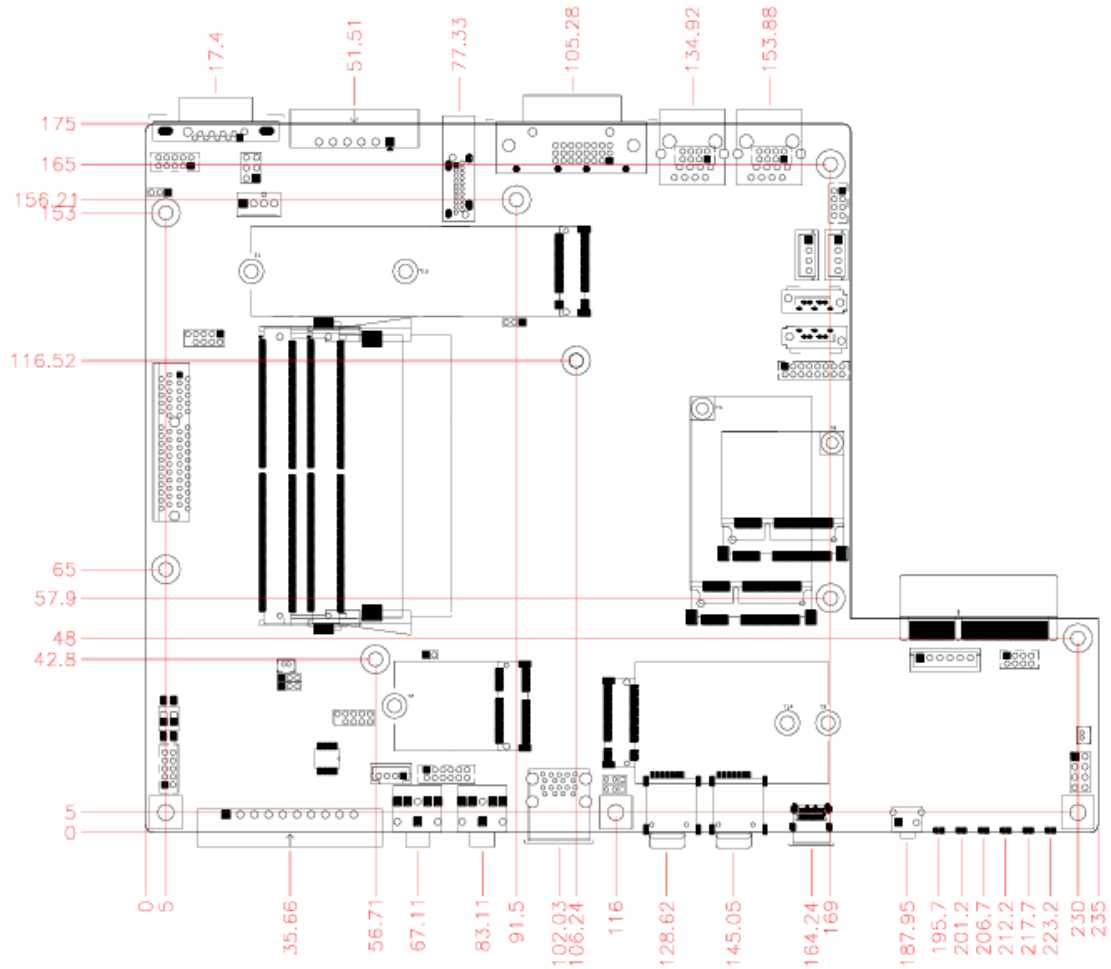

Chapter 2

Hardware Configuration

The information provided in this chapter includes:

- Essential installations
- Information and locations of connectors

2.1 Essential Installations

When installing memory modules, M.2 cards, or other components in the system, first remove the relevant screws to access the designated area. Carefully detach any existing component if applicable, and replace it with the new one, ensuring proper alignment. Once installation is complete, reattach the screws in the reverse order of removal to secure the component.

1. SSD Tray and Front I/O Cover Removal

1. Loosen the four screws securing the SSD trays and pull the trays out.
2. Turn the MPT-7100R upside down and remove the screws as shown in the image to detach the front I/O cover.

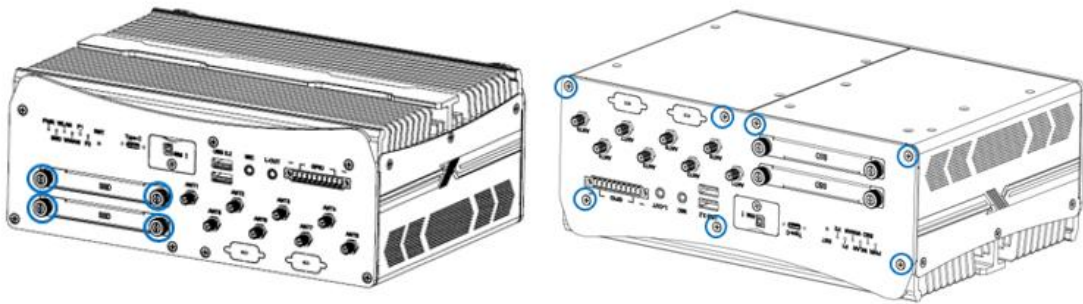

2. Bottom Cover Removal

1. Release the six screws shown to partially open the bottom cover.
2. Then, remove the two screws at the back of the system to fully expose the internal components.

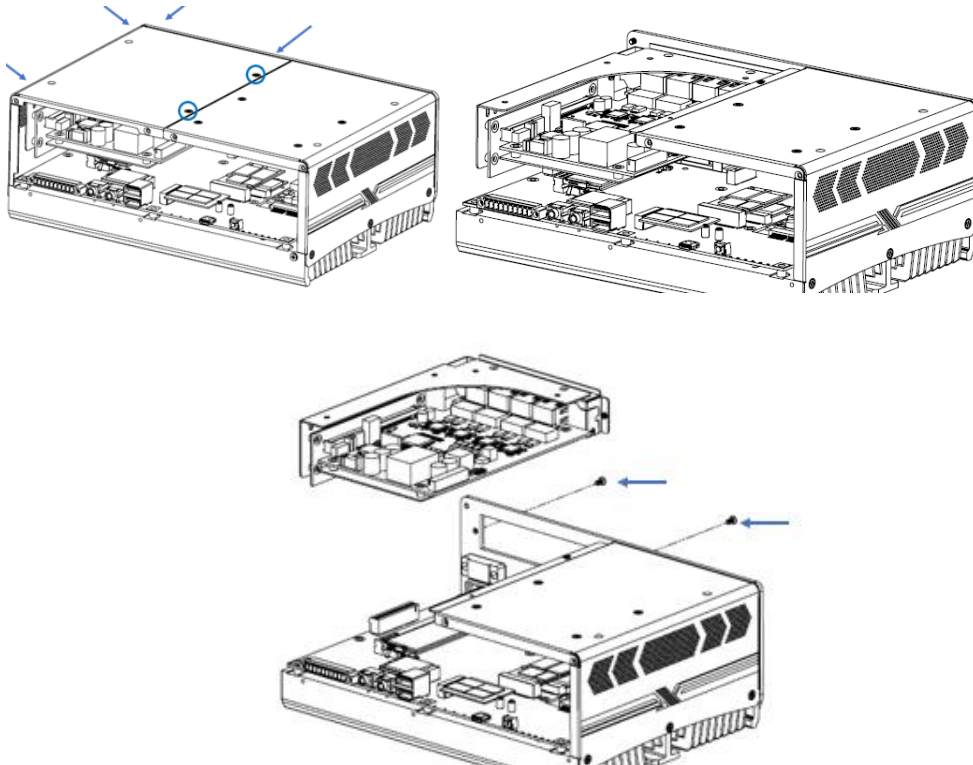

2.1.1 Memory Installation

1. Locate the memory slot and align the notch on the memory module with the key on the slot.
2. Insert the module at an angle, then gently press it down until the side clips snap into place and secure it.

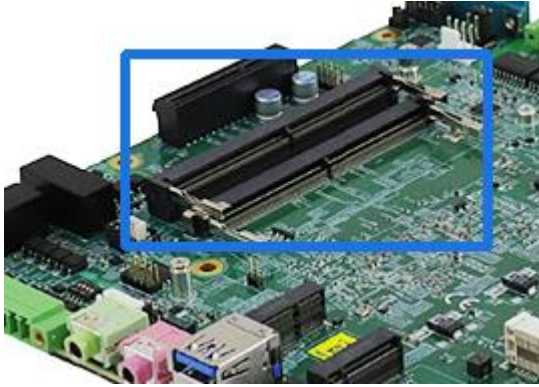

To remove the memory module, push both clips outward to release it.

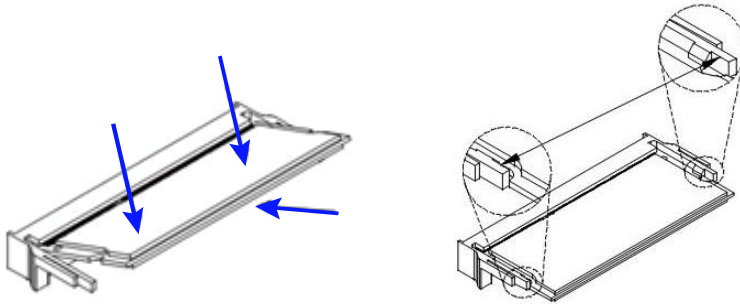

After all components are installed, tighten the eight screws referenced in Step 2 to securely reassemble the device.

2.1.2 Storage Installation

The system supports both 2.5" SSDs and M.2 SATA cards for storage, and you may install either one or both.

Installation for 2.5" SSD

1. Loosen the 2 screws securing each SSD tray (4 screws in total for 2 trays), then pull the tray(s) out.

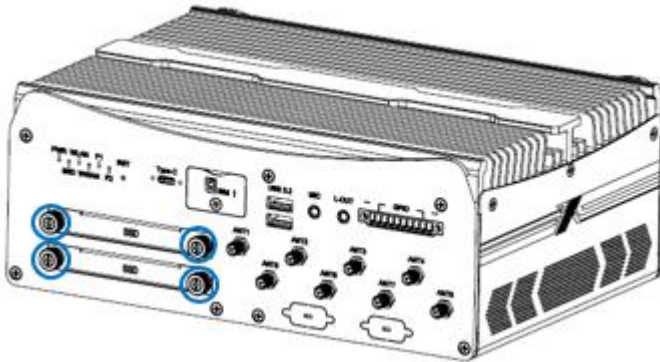

2. Place a 2.5" SSD onto each tray and secure it using the supplied 4 screws per tray.

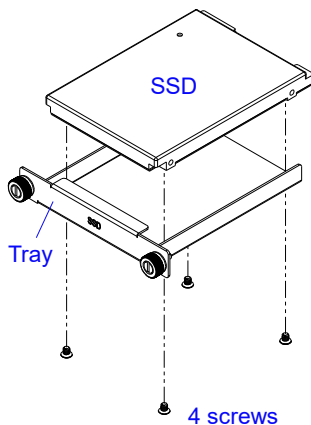

3. Reinsert the tray(s) into the device and fasten them securely.

Installation for M.2 and Mini Cards, and SIM Cards

- After removing the necessary screws as outlined in the *Essential Installation* section, locate the relevant component slots. These include:
 - M.2 (E-key) 2230 (USB 2.0 / PCIe x1)
 - M.2 (M-key) 2280 PCIe x4
 - M.2 (B-key) 3042/52
 - Half-sized Mini PCIe (USB 2.0)
 - Full-sized Mini PCIe (USB 2.0 / PCIe x1)

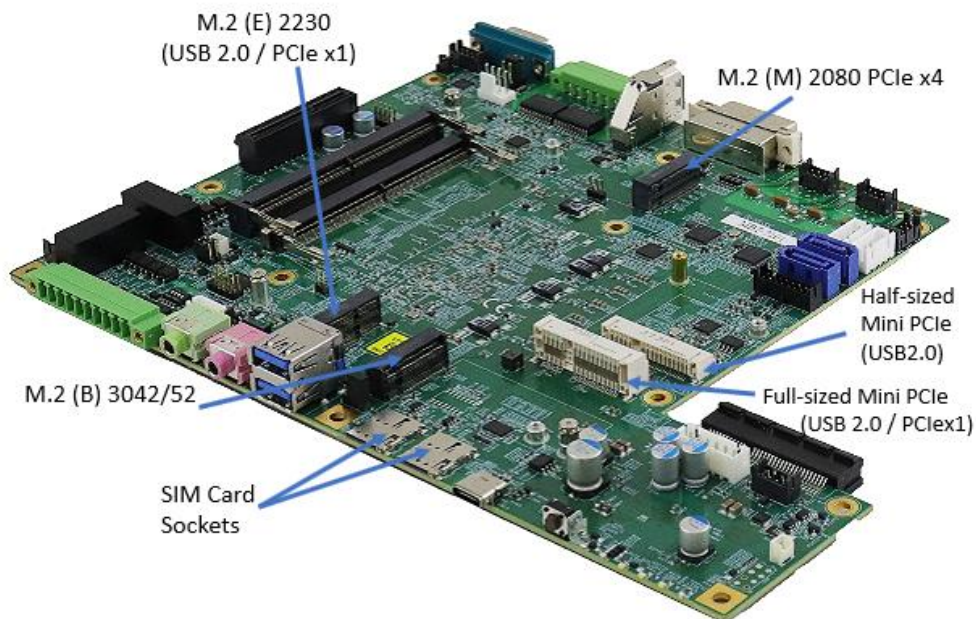

- To access the SIM card sockets, remove the single screw securing the socket cover (as shown below). Insert the micro-SIM card with the chip facing up and push it in using your fingernail. To remove the card, push it again to release.

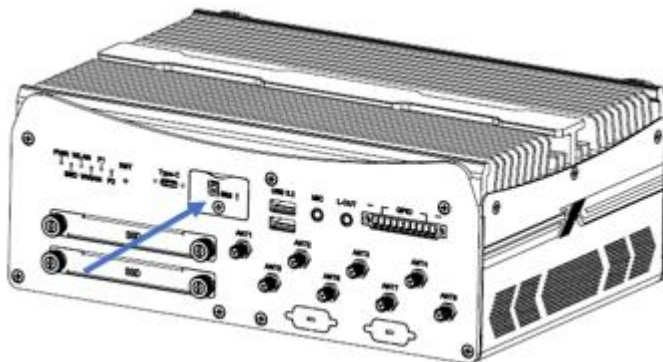

iBASE

3. To install an M.2 card, align its notch with the connector on the interface, insert the card at a slight angle, then press it down and secure it with the brass standoff and screw (if applicable).

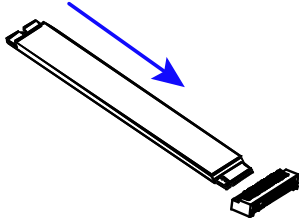

4. To install a Mini PCIe card, align the notch with the connector, insert it slantwise, press it down, and fasten it.

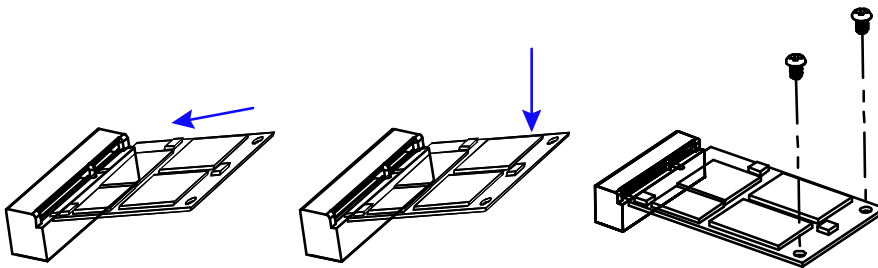

5. Push the mini-PCIe card down, fix it with the supplied 2 flat head screws for full-sized card and with one screw for half-sized card.

2.1.3 Mounting Brackets Installation

1. Turn the MPT-7100R upside down. Attach the mounting brackets to the bottom of the unit and secure them using the four supplied screws, as shown below.

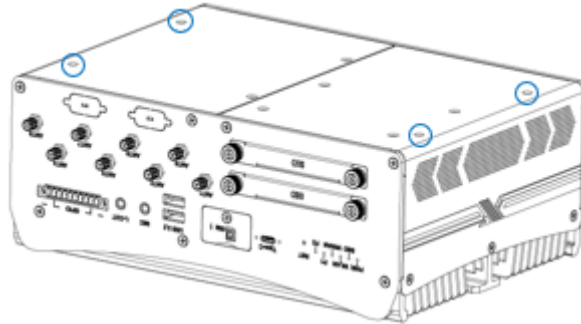

2. Prepare at least four M3 x 6 mm screws to mount the MPT-7100R to the desired wall surface.

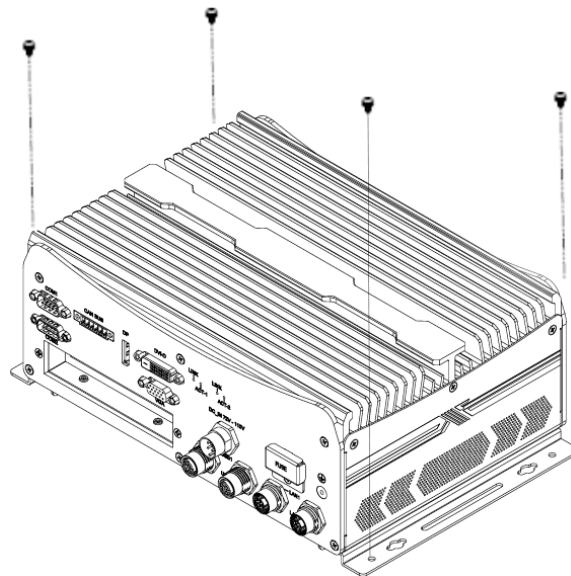

Note: The images are for reference only.

The MPT-7100R can be mounted on various surfaces (with proper stud support). The type of fasteners required depends on the wall material and construction. Mounting fasteners are not included. Please use fasteners rated for medium-duty or heavy-duty loads, and always follow the fastener manufacturer's guidelines to ensure proper and secure installation.

2.1.4 Pinout for COM Ports, Power Input & GPIO Connectors

- COM1 RS-232/422/485 Ports

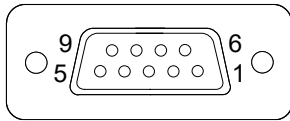

Pin	Assignment	Pin	Assignment
1	DCD, Data carrier detect	6	DSR, Data set ready
2	RXD, Receive data	7	RTS, Request to send
3	TXD, Transmit data	8	CTS, Clear to send
4	DTR, Data terminal ready	9	RI, Ring indicator
5	Ground		

Pin	Assignment		
	RS-232	RS-422	RS-485
1	DCD	6	DATA-
2	RX	7	DATA+
3	TX	8	NC
4	DTR	9	NC
5	Ground	Ground	Ground
6	DSR	NC	NC
7	RTS	NC	NC
8	CTS	NC	NC
9	RI	NC	NC

- COM2 RS-232 Port

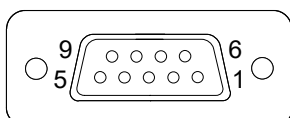

Pin	Assignment	Pin	Assignment
1	DCD, Data carrier detect	6	DSR, Data set ready
2	RXD, Receive data	7	RTS, Request to send
3	TXD, Transmit data	8	CTS, Clear to send
4	DTR, Data terminal ready	9	RI, Ring indicator
5	Ground		

- DC_IN (M12, 4-pin, male, A-code)



Remarks: DC_IN is available in 24V for the **MPT-7100R** model and 72V~110V for the **MPT-7100RH** model.

Pin	Assignment	Pin	Assignment
1	Ignition	3	Ground
2	Ground	4	DC-Input

- USB 2.0 Port (M12, 4-pin, female, A-code)

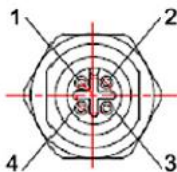

Pin	Assignment	Pin	Assignment
1	VCC(+5V)	3	Data +
2	Data -	4	Ground

iBASE

- GPIO Connector (Terminal block)

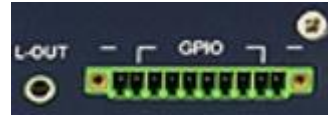
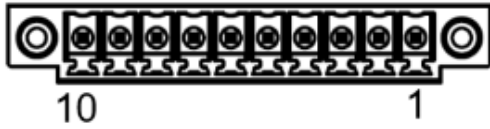

Pin	Assignment	Pin	Assignment
1	DI0	6	DO1
2	DI1	7	DO2
3	DI2	8	DO3
4	DI3	9	VDO_ISO_COM
5	DO0	10	GND

- LAN Connector (M12, 8-pin, Female, X-code)



Pin	Assignment	Pin	Assignment
1	MX1+	5	MX4+
2	MX1-	6	MX4-
3	MX2+	7	MX3+
4	MX2-	8	MX3-

- CANBUS

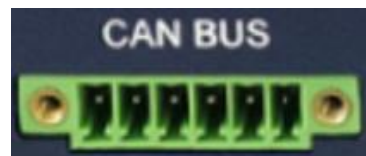

Pin	Assignment	Pin	Assignment
1	CAN_DH1	4	GND_ISO_CAN2
2	CAN_DL1	5	CAN_DL2
3	GND_ISO_CAN1	6	CAN_DH2

Setting the Jumpers

Set up and configure your device by using jumpers for various settings and features according to your needs and applications. Contact your supplier if you have doubts about the best configuration for your use.

Jumpers are short-length conductors consisting of several metal pins with a non-conductive base mounted on the circuit board. Jumper caps are used to have the functions and features enabled or disabled. If a jumper has 3 pins, you can connect either PIN1 to PIN2 or PIN2 to PIN3 by shorting.

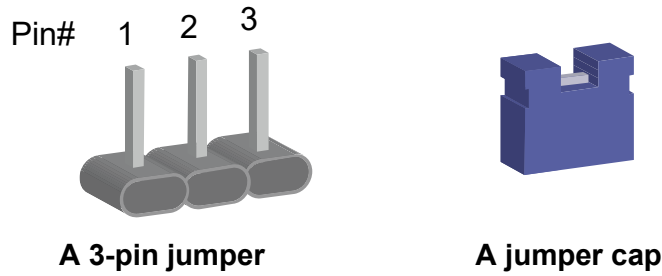

Refer to the illustration below to set jumpers.

Pin closed	Oblique view	Schematic illustration in the manual
Open		
1-2		
2-3		

When two pins of a jumper are encased in a jumper cap, this jumper is **closed**, i.e. turned **On**.

When a jumper cap is removed from two jumper pins, this jumper is **open**, i.e. turned **Off**.

2.2 Jumper & Connector Locations on Motherboard

Motherboard: MBT-7100R

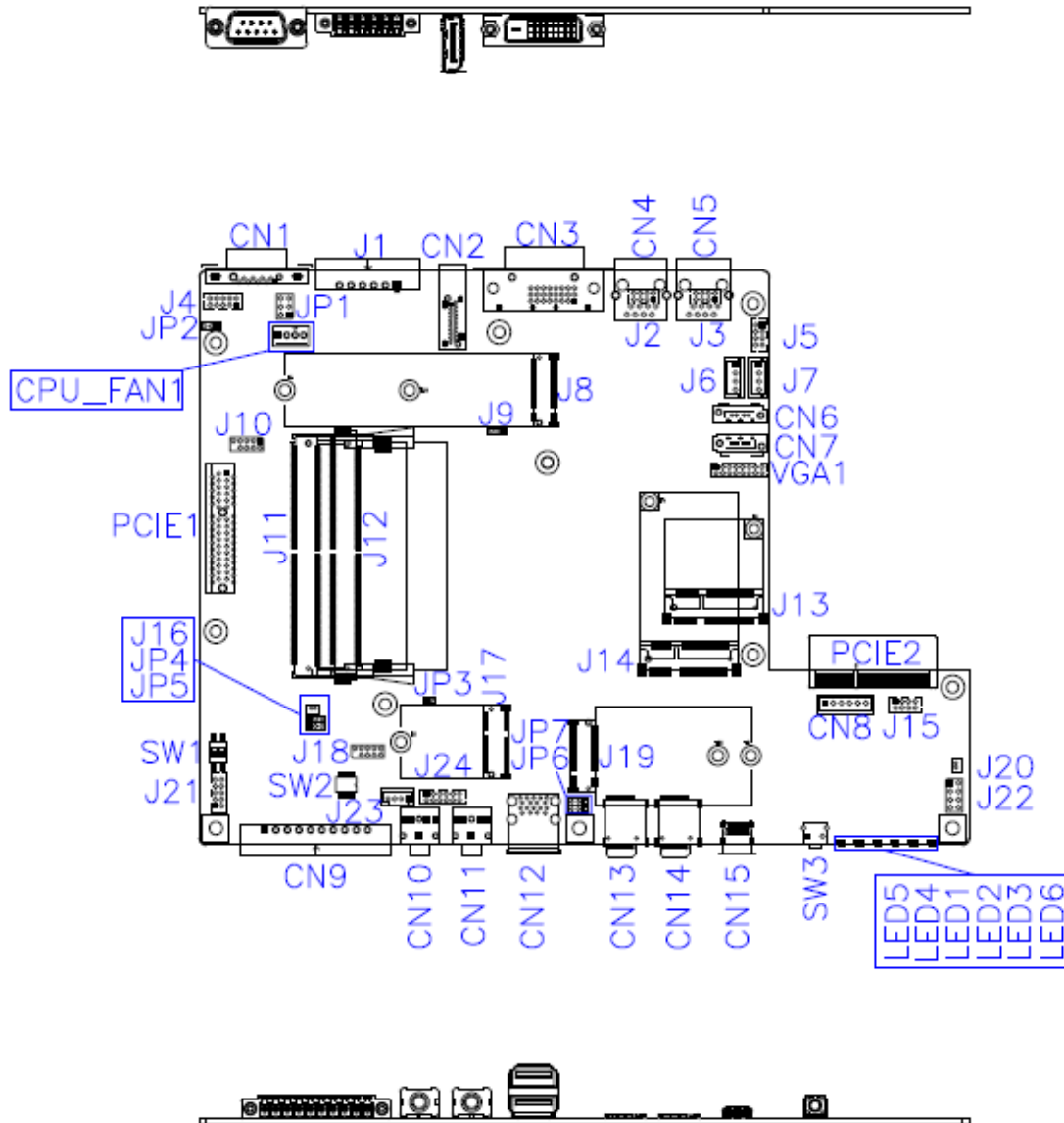

MBT-7100R - top

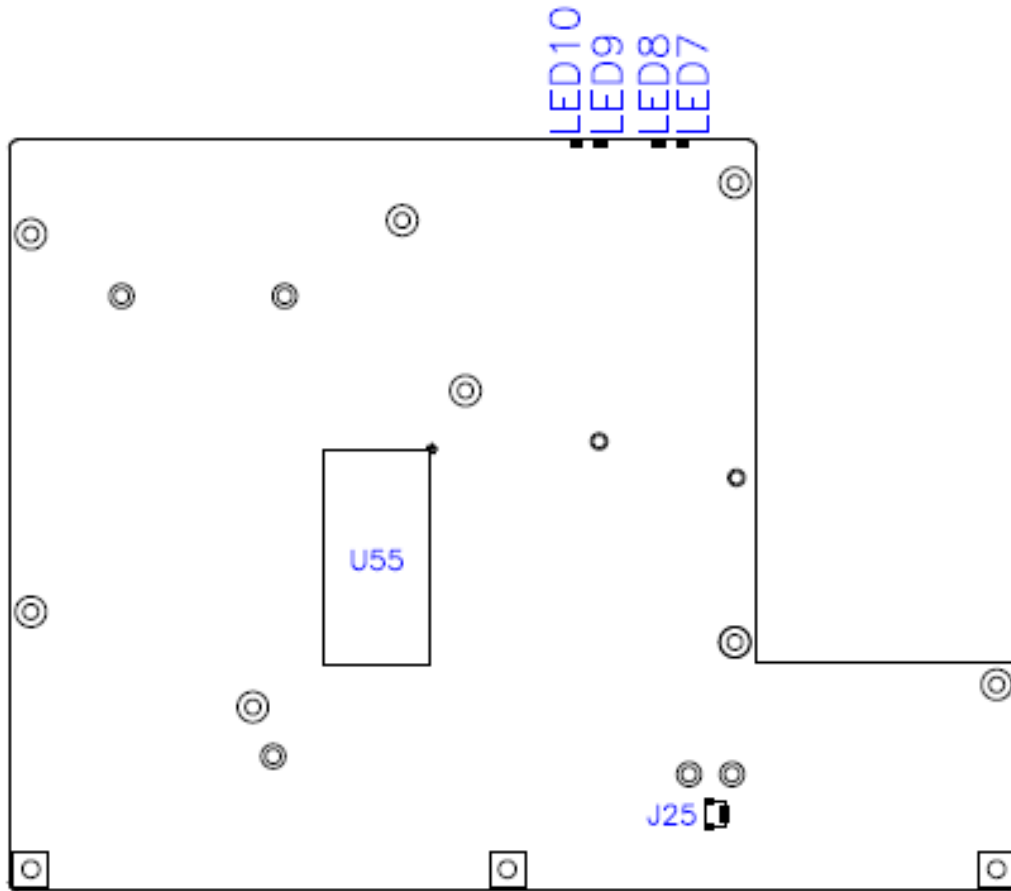

MBT-7100R - bottom

2.3 Jumpers Quick Reference

Jumper	Function
JP1	COM1 RS232 RI/+5V/+12V Power Setting
JP2	ATX/AT Mode Setting
JP3	Flash Descriptor Security Override
JP4	Clear CMOS Contents
JP5	Clear ME Contents
JP6	SIM Card Select



2.4.1 JP1: COM1 RS232 RI/+5V/+12V Power Setting

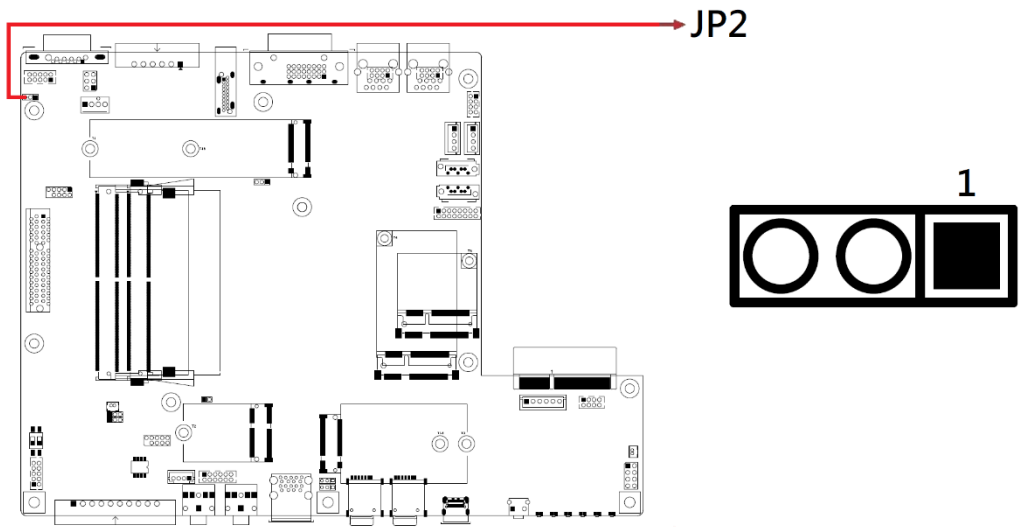

JP1	Setting	Function
	Pin 1-3 Short/Closed	+12V
	Pin 3-4 Short/Closed	RI
	Pin 5-3 Short/Closed	+5V

2.4.2 JP2: ATX / AT Mode Setting



JP2	Setting	Function
 1	Pin 1-2 Short/Closed	ATX
 1	Pin 2-3 Short/Closed	AT

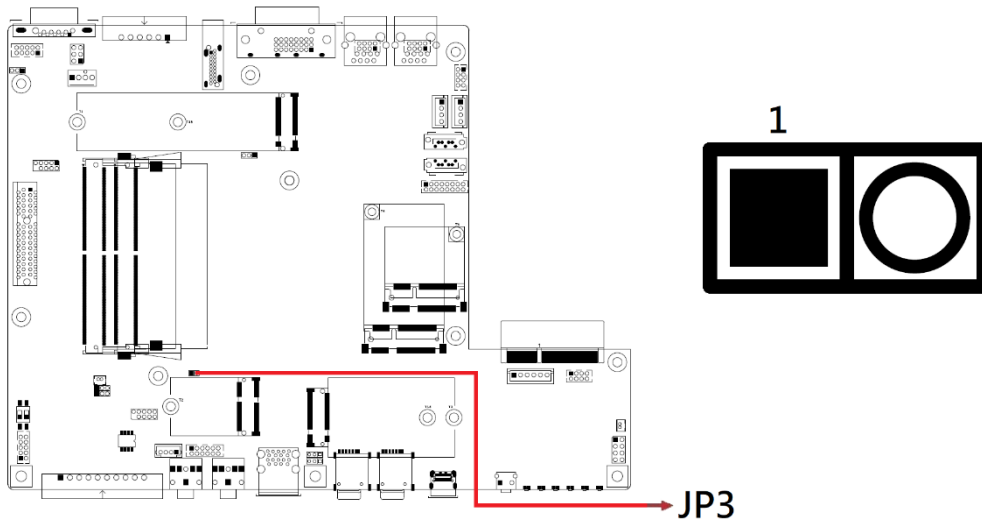

2.4.3 J3: Flash Descriptor Security Override

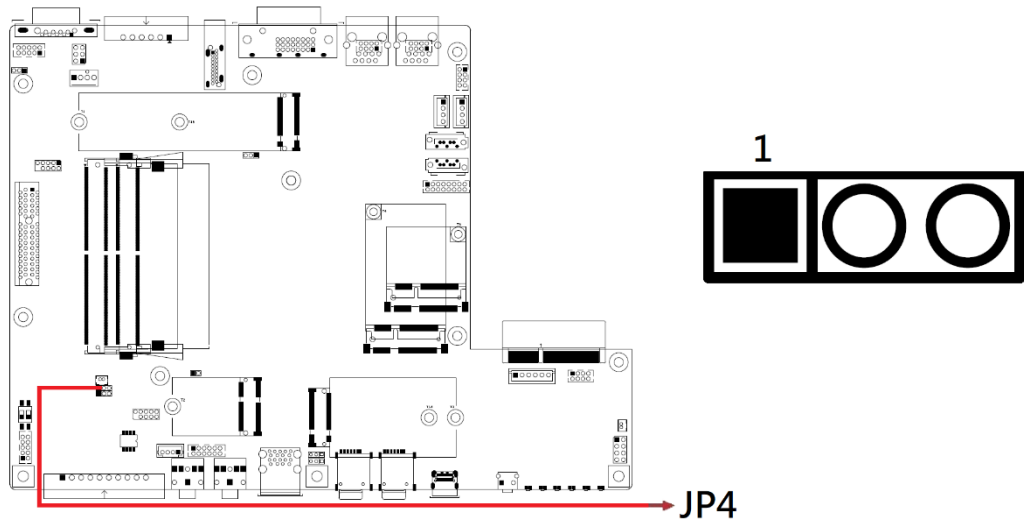

JP3	Flash Descriptor Security Override
Open	Disabled (Default)
Close	Enabled

2.4.4 JP4: Clear CMOS Contents



JP4	Function	Setting
 1	Normal (default)	1-2 closed
 1	Clear CMOS	2-3 closed

2.4.5 JP5: Clear ME Contents

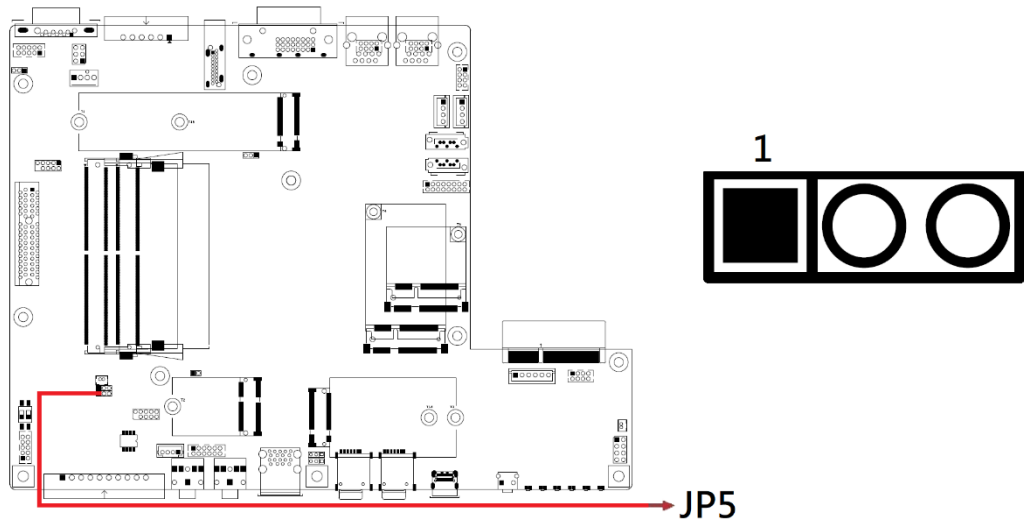

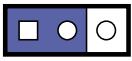
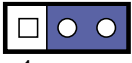
JP5	Function	Setting
 1	Normal (default)	1-2 closed
 1	Clear ME Register	2-3 closed

2.4.6 JP6: SIM Card Select (for CN14 SIM2)

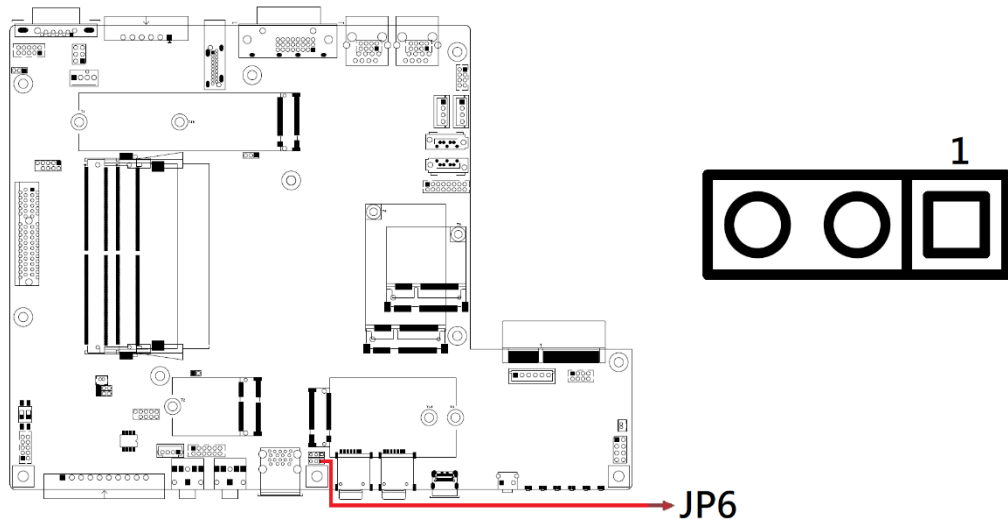

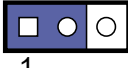
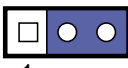
JP6	Setting	Function
 1	Pin 1-2 Short/Closed	For M.2-2
 1	Pin 2-3 Short/Closed	For Mini- PCIE

2.4.7 JP7: M.2 B-key Sierra EM9191 USB/PCIE Select

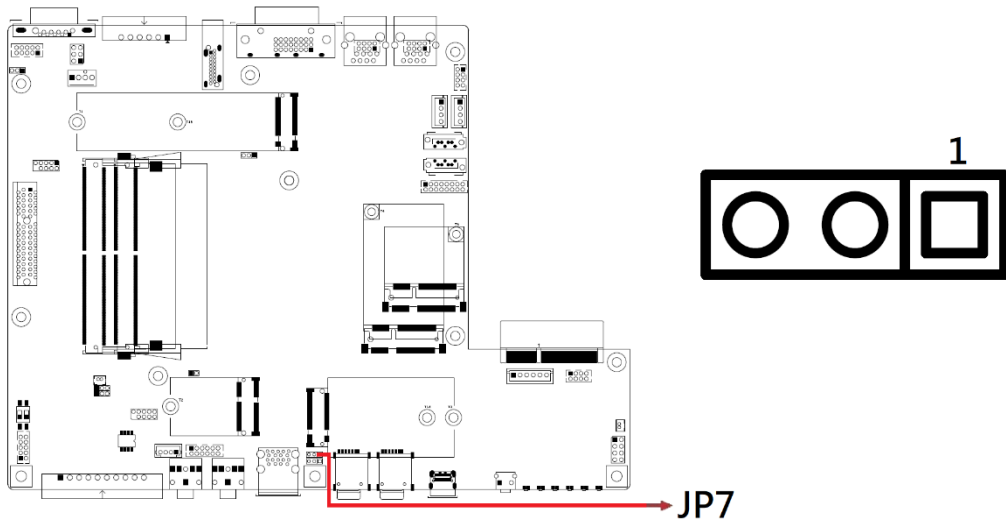

JP7	Setting	Function
 1	Pin 1-2 Short/Closed	For PCI-E
 1	Pin 2-3 Short/Closed	For USB 3.0

2.4 Connectors on MBT-7101

Connector	Function
PCIE1	PCIEX4 Slot
PCIE2	DC_in Connector (+12V)
CN1	COM1 RS232/422/485 Port
CN2	DisplayPort Connector
CN3	DVI-D Connector
CN4, CN5 (option)	Gigabit LAN Connectors
CN6, CN7	SATA2 Connector
CN8	+12V Connector
CN9	Digital I/O Connector
CN10, CN11	Audio (Front) Connector
CN12	USB3.0 Connector
CN13	SIM (J19-1) Connector
CN14	SIM2 (J14, J19-2) Connector
CN15	Type-C Connector
J1	CAN Port Pin header
J2, J3	Gigabit LAN Pin Headers
J4	COM2 RS232 Connector
J6, J7	SATA HDD Power Connectors
J8	M.2 (M) 2080 PCIE X4 Connector
J11	DDR5 SO-DIMM (CH-A) Sockets
J12	DDR5 SO-DIMM (CH-B) Sockets
J13	Half-sized Mini PCIE (USB 2.0) Connector
J14	Full-sized Mini PCIE (USB 2.0/ PCIe x1) Connector
J15	Signals for the Power Board
J16	Battery Connector
J17	M.2 (E) 2230 Connector (USB 2.0/ PCIe x1)
J18	For SPI Debug Tools Pin Header
J19	M.2 (B) 3042/52 Connector (PCIE x1 / USB 3.0)
J20	Power Button Pin Header
J21	COM3~COM4 RS485 Connector
J24	Audio Pin Header
SW1_1	COM3 RS-485 Terminal Register
SW1_2	COM4 RS-485 Terminal Register
SW2	Digital IO Pull High to +5V Switch
SW3	Reset Button
VGA1	CRT Pin Header

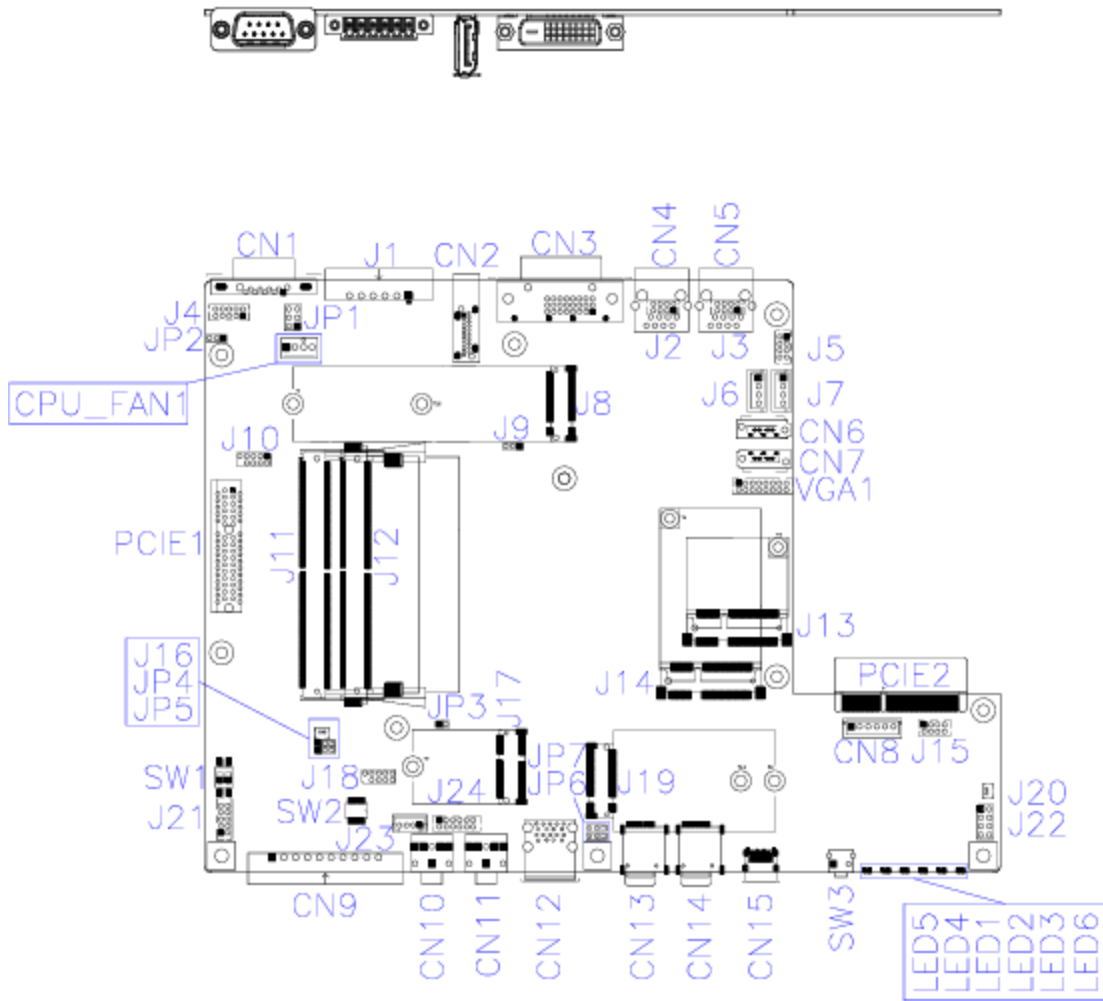

Jumper/Switch/Connector Locations

2.5.1 PCIE1: PCIe4 Slot

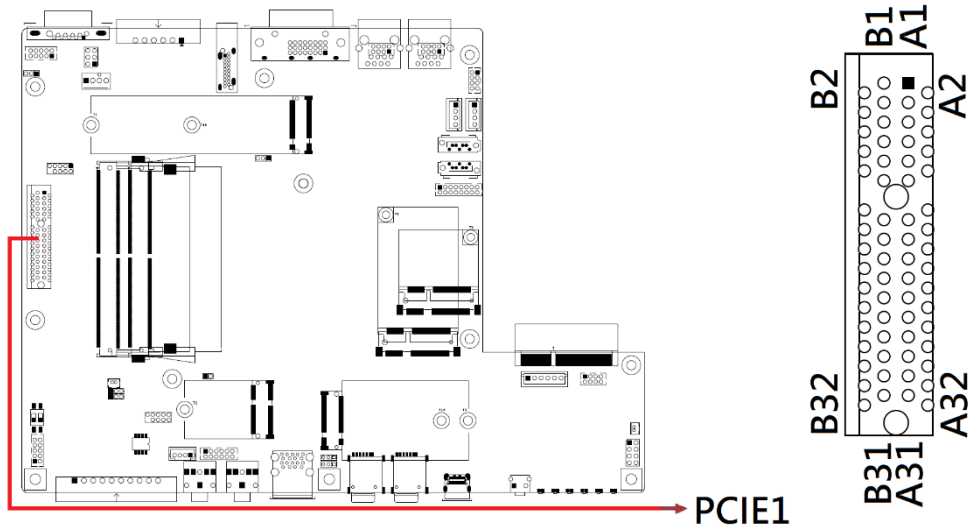

2.5.2 PCIE2: DC_in Connector (+12V)

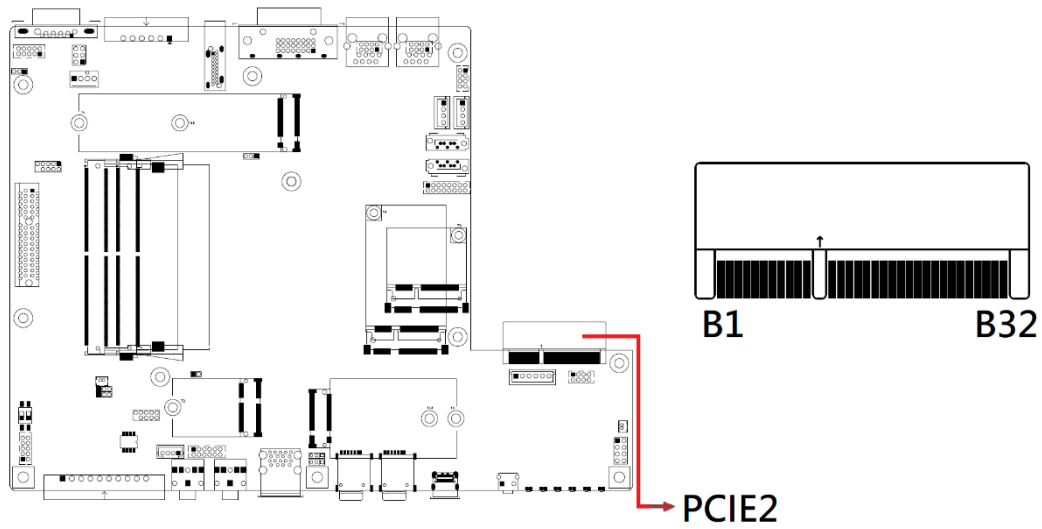

2.5.3 SW1_1: COM3 RS-485 Terminal Register

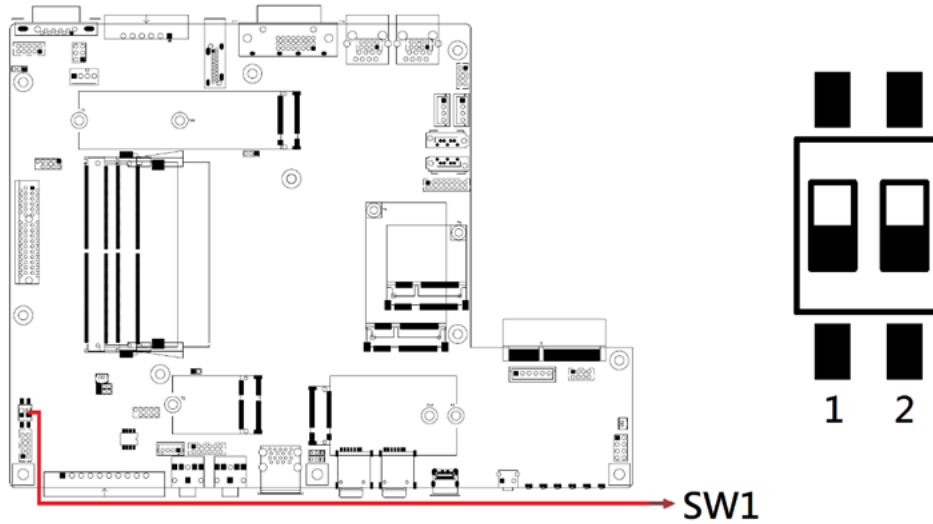

Setting	Function
Pin_1 Off	COM3 Terminal Disable (default)
Pin_1 On	COM3 Terminal Enable

2.5.4 SW1_2: COM4 RS-485 Terminal Register

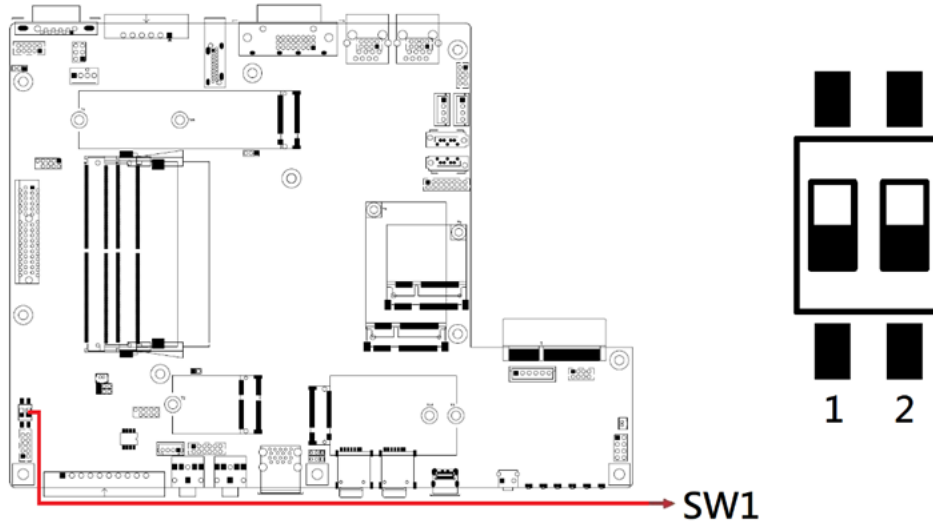

Setting	Function
Pin_2 Off	COM4 Terminal Disable (default)
Pin_2 On	COM4 Terminal Enable

2.5.5 SW2: Digital IO Pull High to +5V Switch

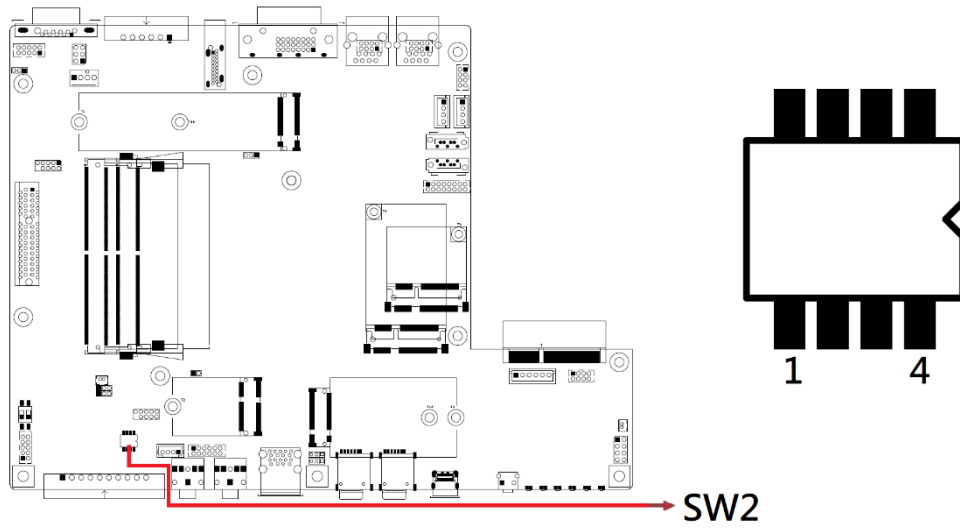

Pin	Assignment	Pin	Assignment
1	DO3	5	5V
2	DO2	6	5V
3	DO1	7	5V
4	DO0	8	5V

(On: Pull High to +5V)

2.5.6 SW3: Reset Button

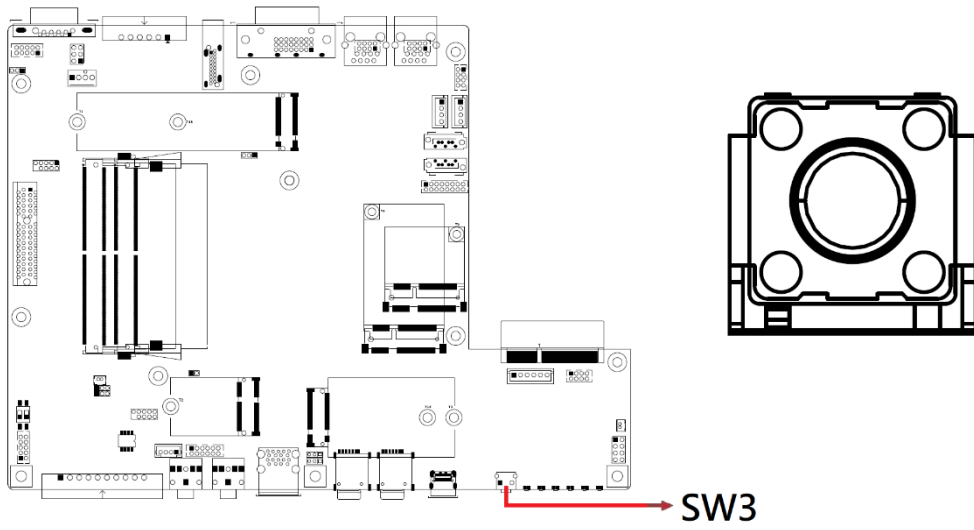

2.5.7 J21: COM3 / COM4 RS485 Connector

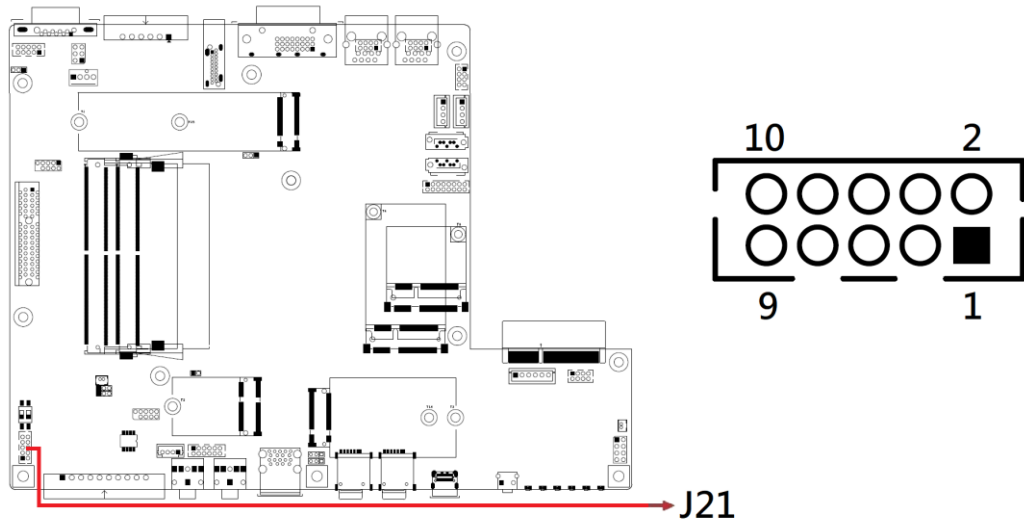

Pin	Assignment	Pin	Assignment
1	NC	2	NC
3	GND	4	GND
5	RS485-DATA3-	6	RS485-DATA4- 4-
7	RS485-DATA3+	8	RS485-DATA4+
9	GND	10	GND

2.5.8 CN1: COM1 RS232/422/485 Port

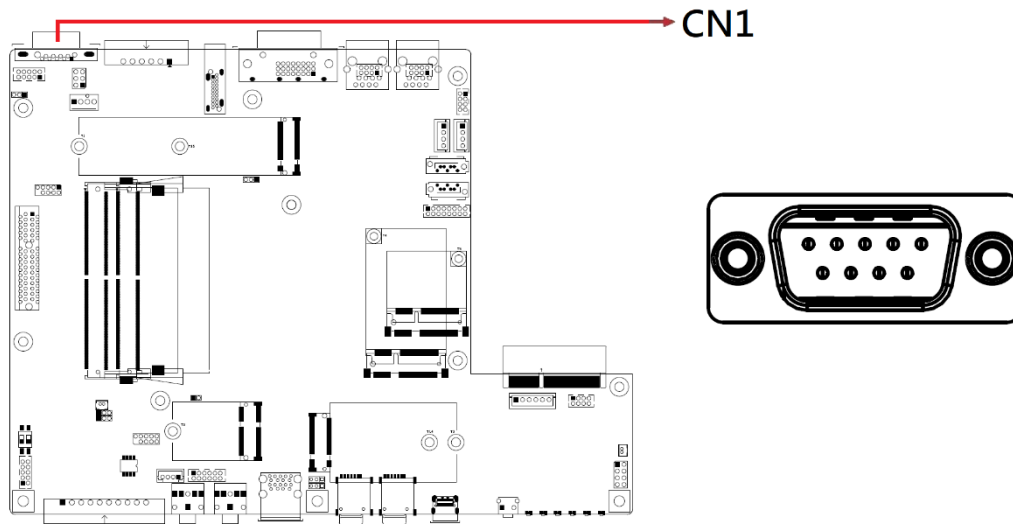

*COM1 setting is selectable in BIOS.

Pin	Assignment		
	RS-232	RS-422	RS-485
1	DCD	TX-	DATA-
2	RX	TX+	DATA+
3	TX	RX+	NC
4	DTR	RX-	NC
5	Ground	Ground	Ground
6	DSR	NC	NC
7	RTS	NC	NC
8	CTS	NC	NC
9	RI	NC	NC

2.5.9 CN2: DisplayPort connector

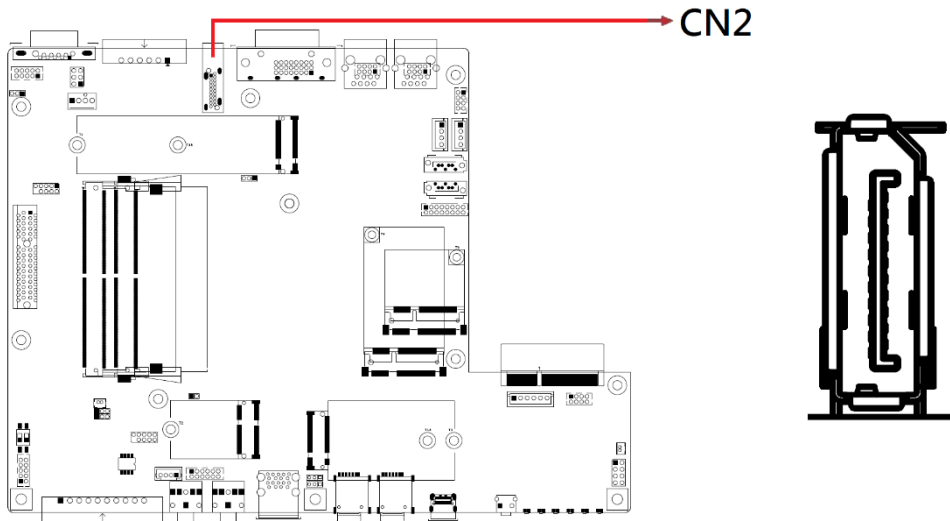

2.5.10 CN3: DVI-D Connector

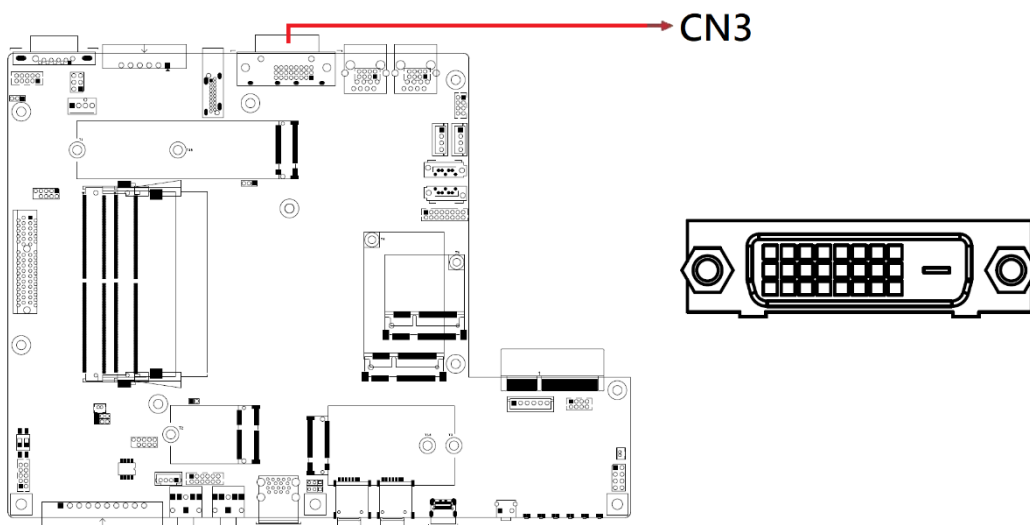

2.5.11 CN4, CN5: 2.5G LAN Connectors (option)

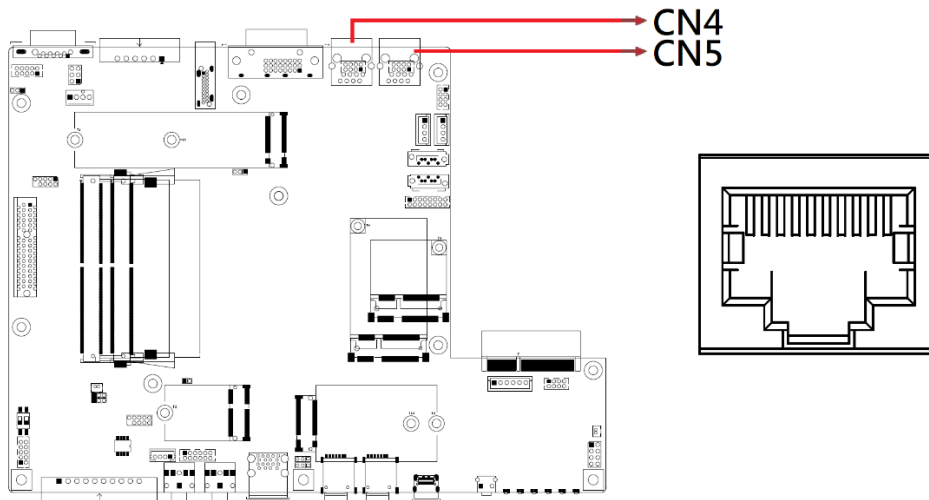

2.5.12 J2, J3: 2.5G LAN Pin Header

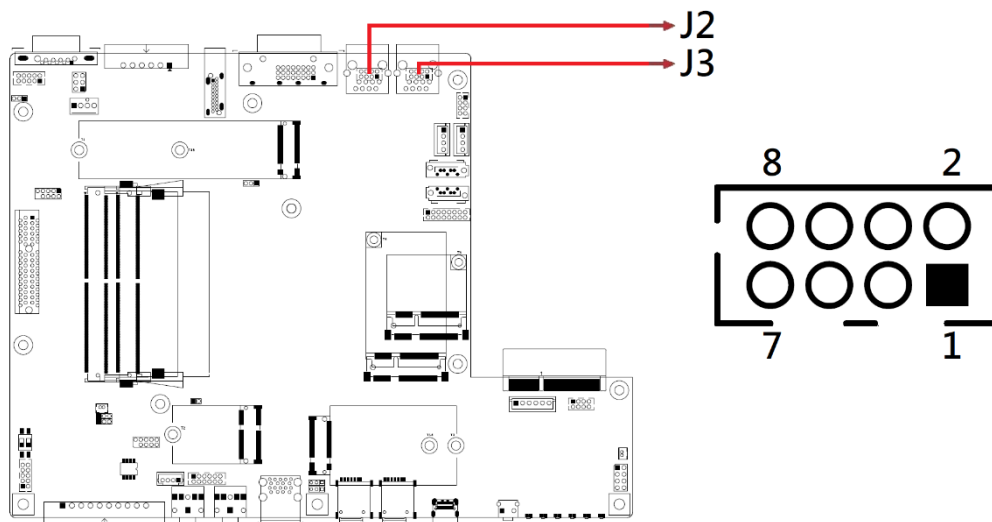

Pin	Assignment	Pin	Assignment
1	MXP0	2	MXN0
3	MXP1	4	MXN1
5	MXN2	6	MXP2
7	MXP3	8	MXN3

2.5.13 CN6, CN7: SATA2 Connector

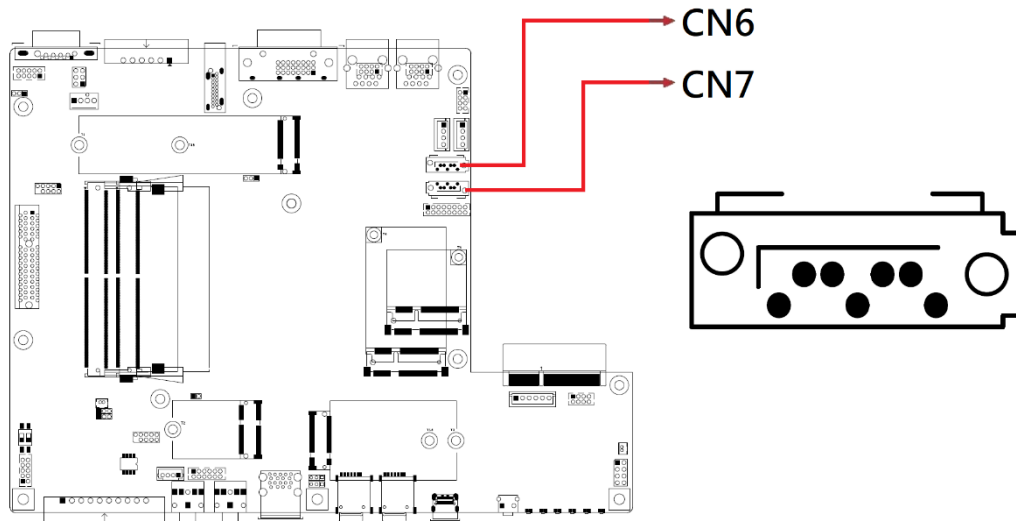

2.5.14 CN8: +12V Connector

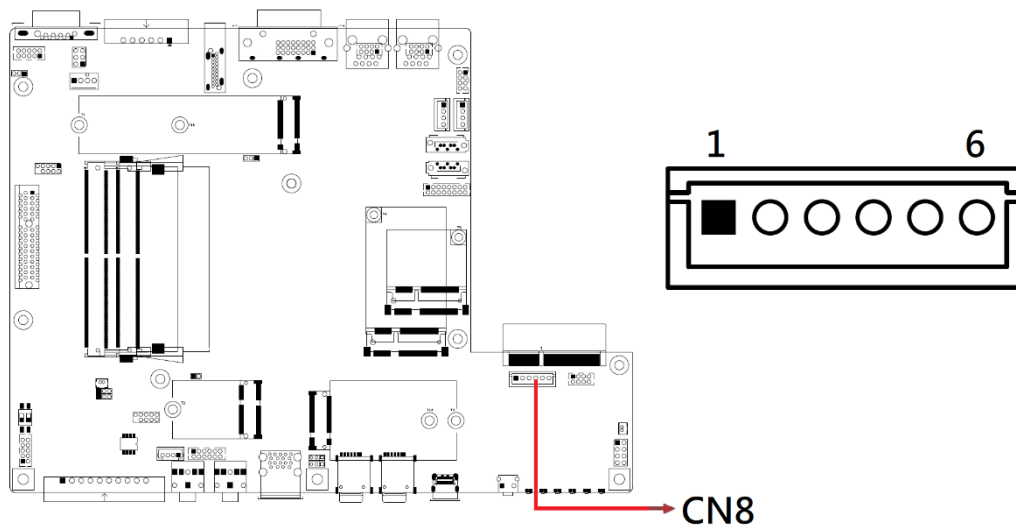

Pin	Assignment	Pin	Assignment
1	+12V	2	+12V
3	+12V	4	GND
5	GND	6	GND

2.5.15 CN9: Digital I/O Connector

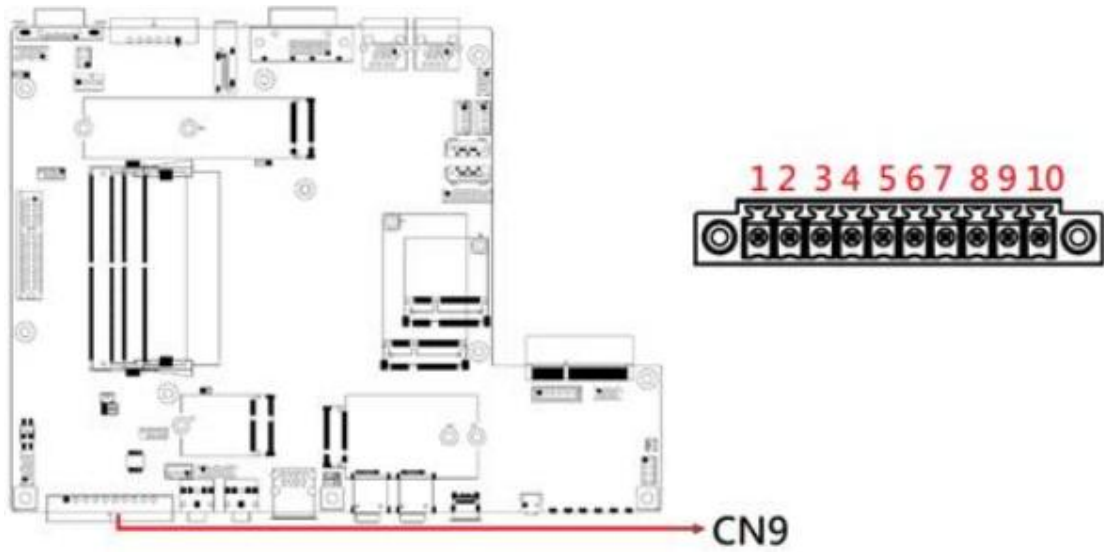

Pin	Assignment	Pin	Assignment
1	DI0	6	DO1
2	DI1	7	DO2
3	DI2	8	DO3
4	DI3	9	VDO_ISO_COM
5	DO0	10	GND

2.5.16 CN10, CN11: Audio (Front) Connector

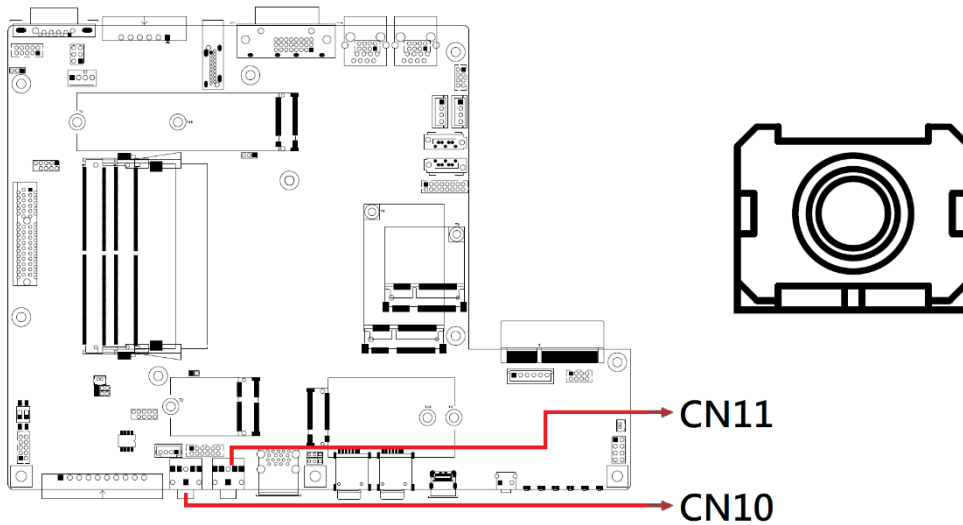

2.5.17 J24: Audio Pin Header

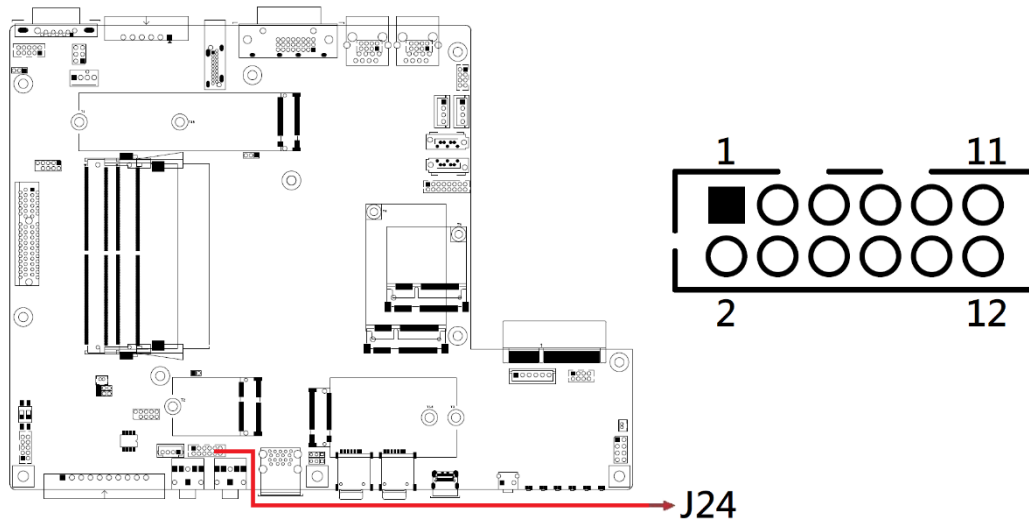

Pin	Assignment	Pin	Assignment
1	LINE OUT_L	2	LINE OUT_R
3	FRONT_JD	4	GND
5	LINE IN_L	6	LINE IN_R
7	LINE_JD	8	GND
9	MIC_L	10	MIC_R
11	MIC_JD	12	GND

2.5.18 CN12: Dual USB 3.0 Connector

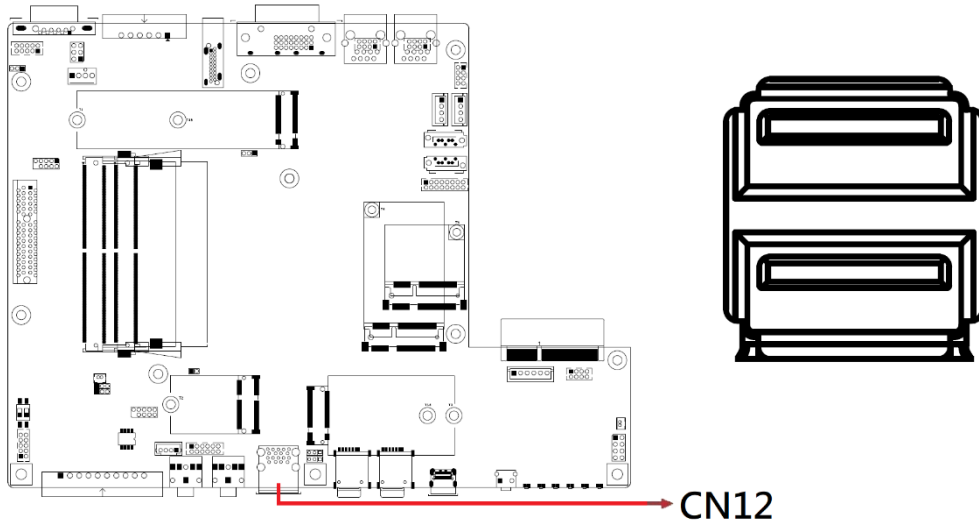

2.5.19 CN13: SIM (J19-1) Connector

2.5.20 CN14: SIM2 (J14, J19-2) Connector

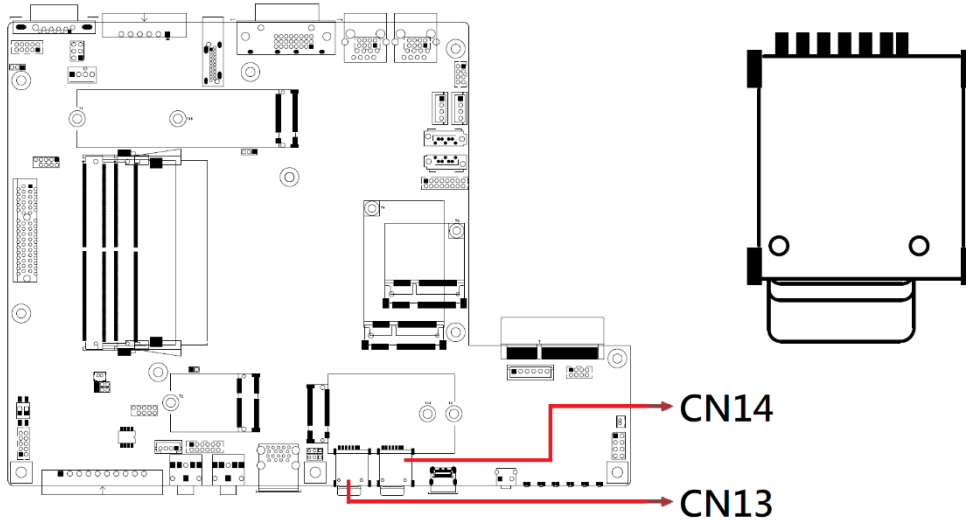

*CN14 SIM2 settings via JP6

2.5.21 CN15: Type-C Connector for 5,9.15.20V Power Out USB3.DP

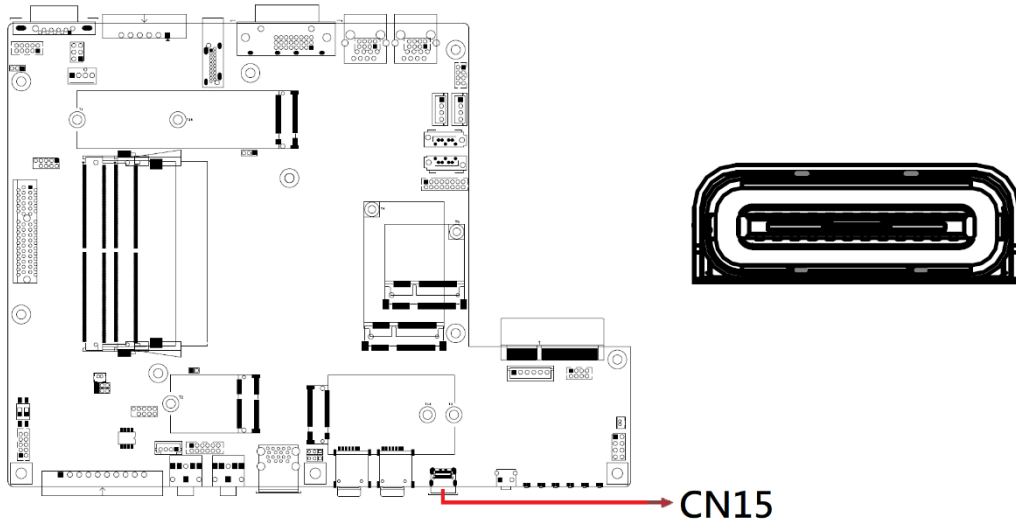

2.5.22 VGA1: CRT Connector

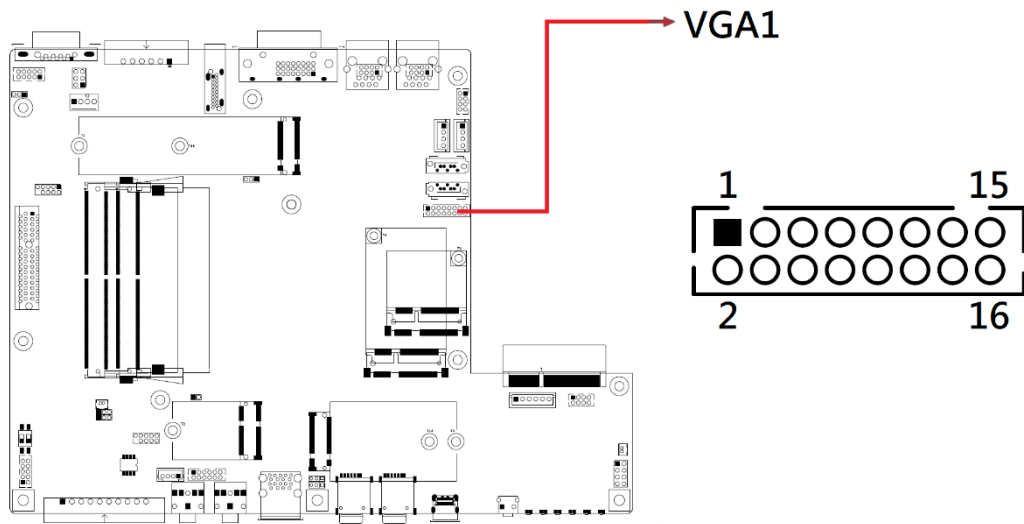

Pin	Assignment	Pin	Assignment
1	Red	2	VCC
3	Green	4	GND
5	Blue	6	N.C.
7	N.C.	8	DDCDATA
9	GND	10	HSYNC
11	GND	12	VSYNC
13	GND	14	DDCCLK
15	GND	16	N.C.

2.5.23 J1: CAN Port Connector

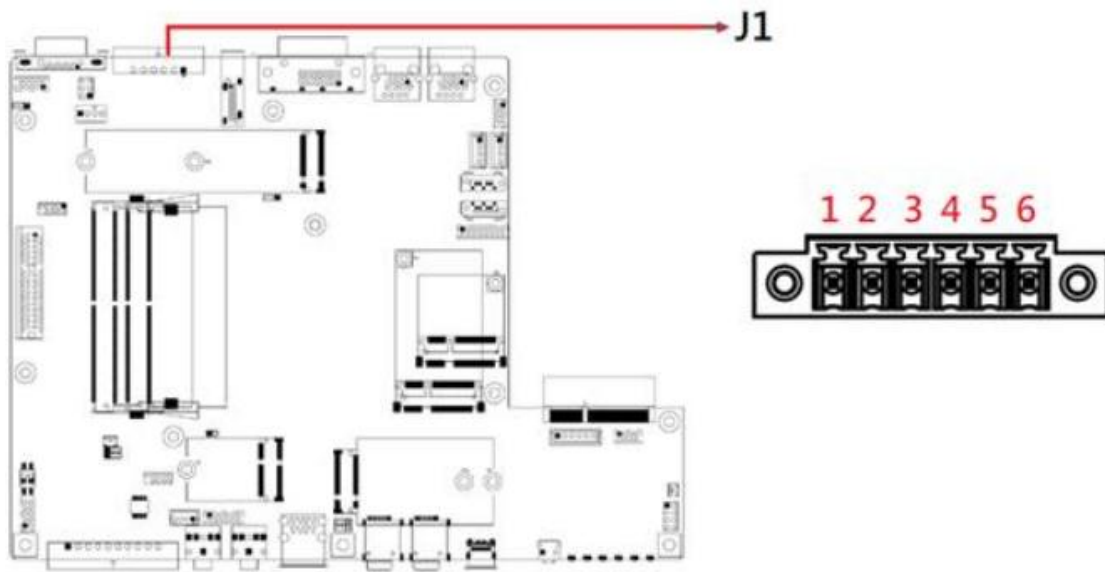

Pin	Assignment	Pin	Assignment
1	CAN_DH1	4	GND_ISO_CAN2
2	CAN_DL1	5	CAN_DL2
3	GND_ISO_CAN1	6	CAN_DH2

2.5.24 J4: COM2 RS232 Connector

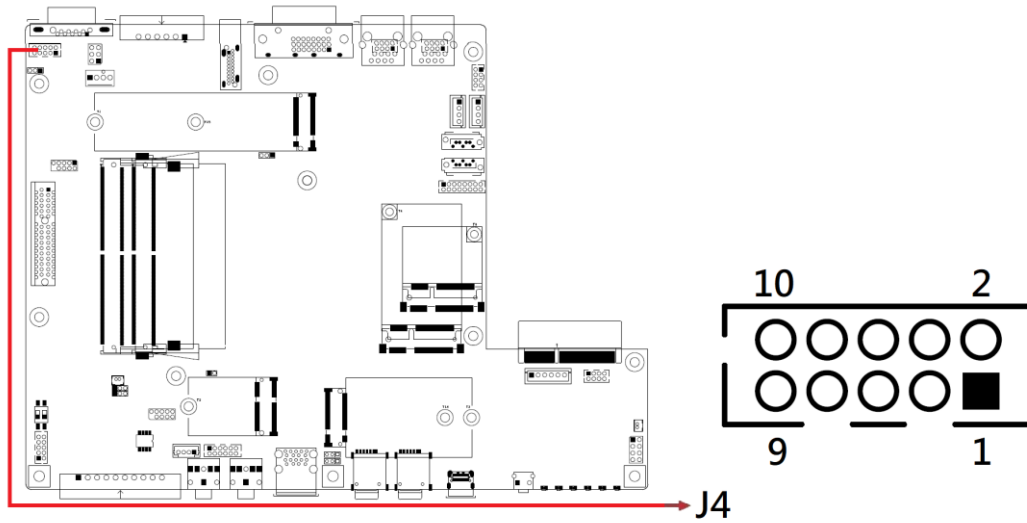

Pin	Assignment	Pin	Assignment
1	DCD	2	SIN
3	SOUT	4	DTR
5	GND	6	DSR
7	RTS	8	CTS
9	RI	10	N/C

2.5.25 J5: USB 2.0 x2 Pin Header

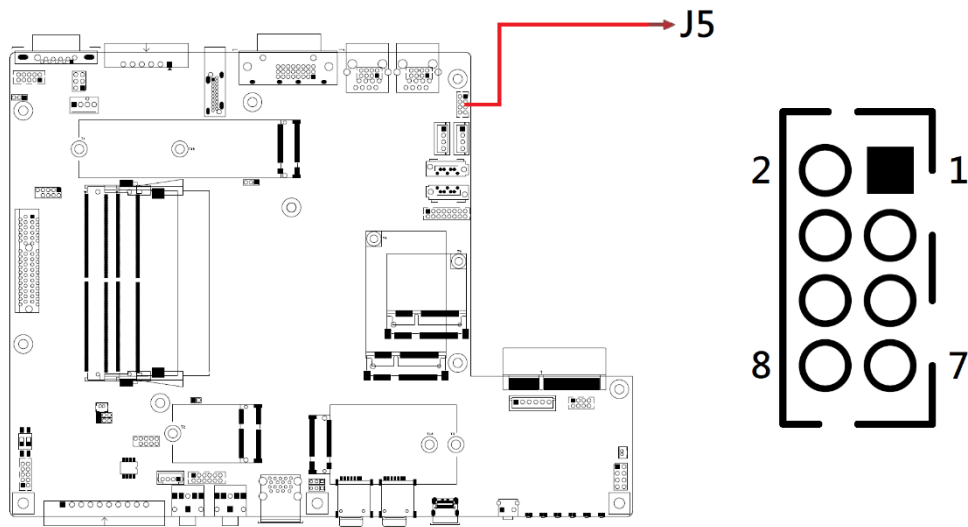

Pin	Assignment	Pin	Assignment
1	VCC	2	GND
3	P5-	4	P6+
5	P5+	6	P6-
7	GND	8	VCC

2.5.26 J6, J7: SATA HDD Power Connectors

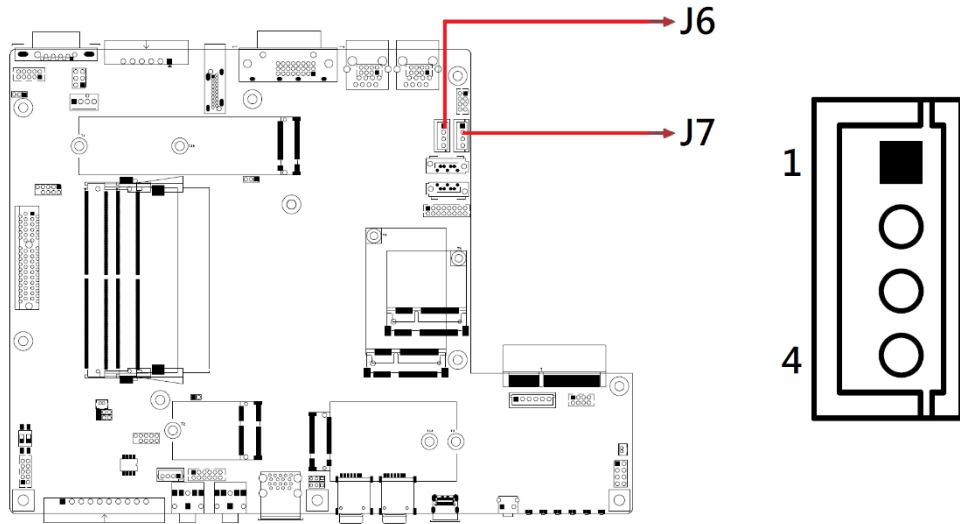

Pin	Assignment
1	+5V
2	Ground
3	Ground
4	+12V

2.5.27 J8: M.2(M) 2080 PCIE X4 Connector

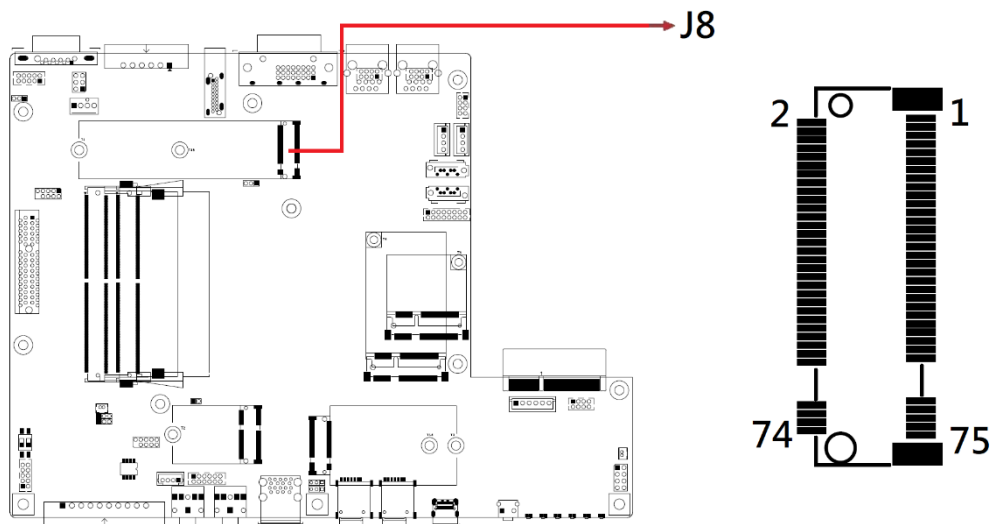

2.5.28 J10: Debug Port

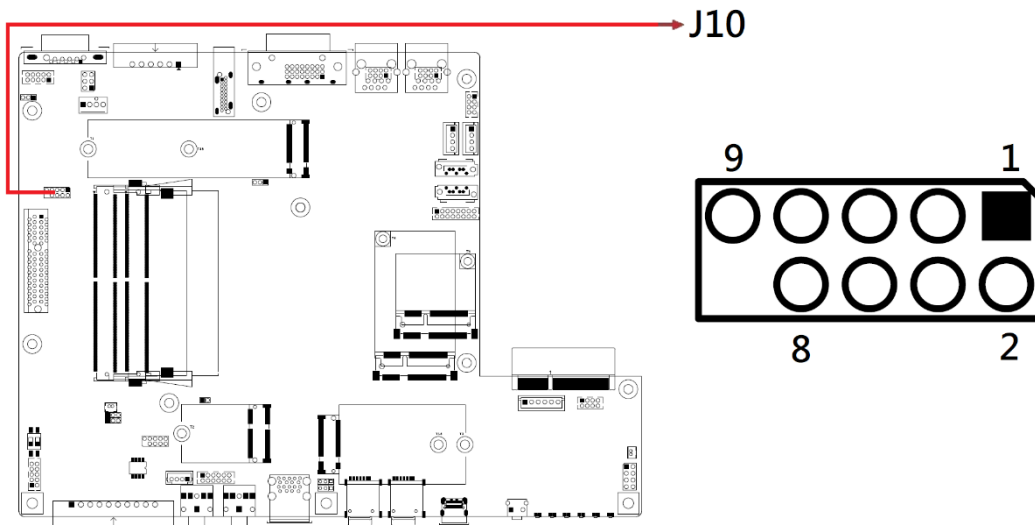

2.5.29 J11: DDR5 SO-DIMM (CH-A) Sockets

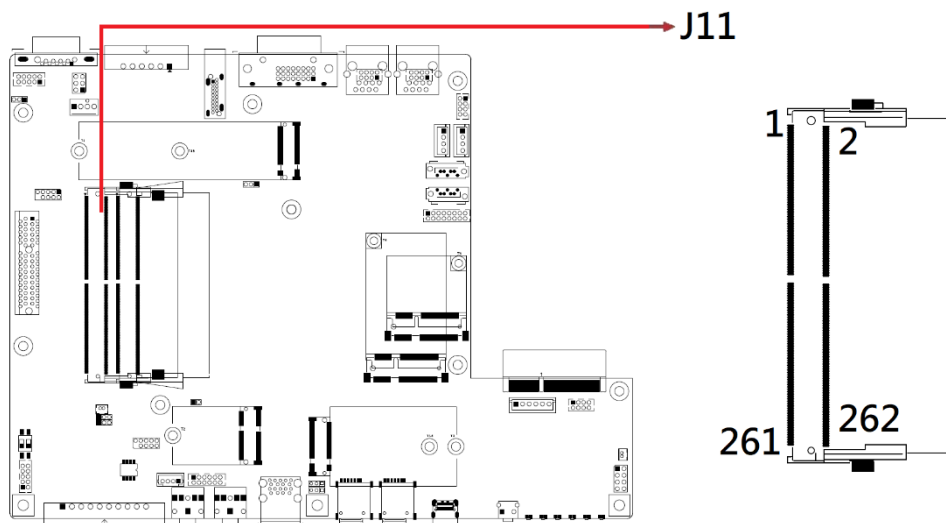

2.5.30 J12: DDR5 SO-DIMM (CH-B) Sockets

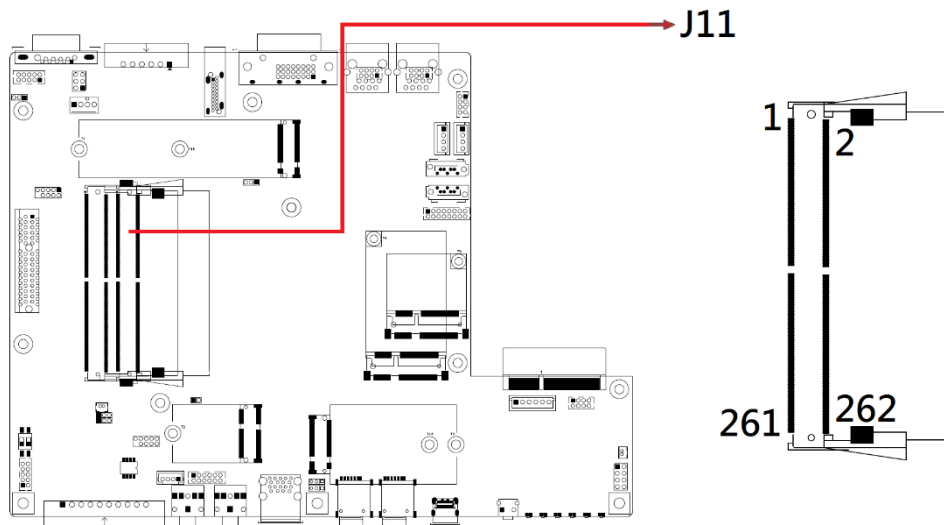

2.5.31 J13: Half-sized Mini PCIE (USB2.0) Connector

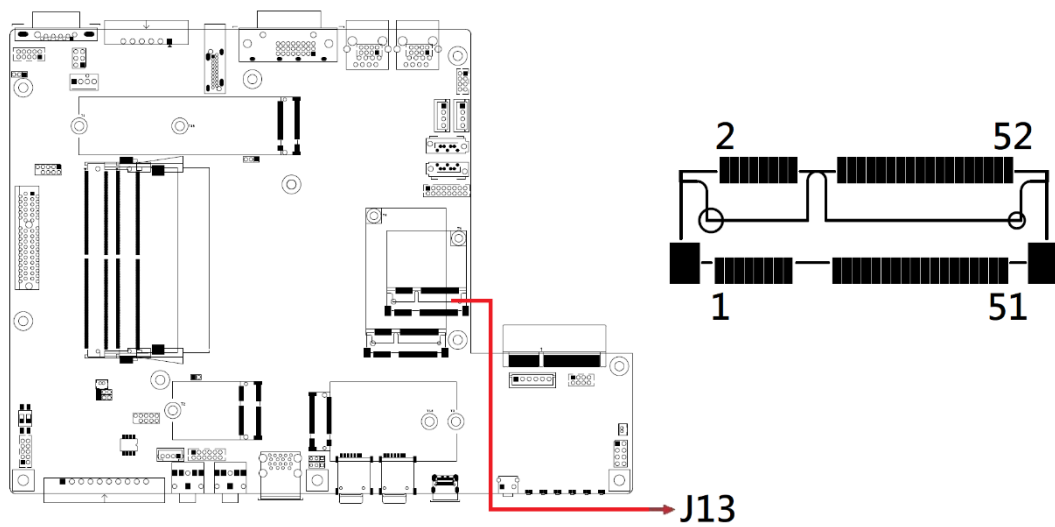

2.5.32 J14: Full-sized Mini PCIE (USB2.0/ PCIe x1) Connector

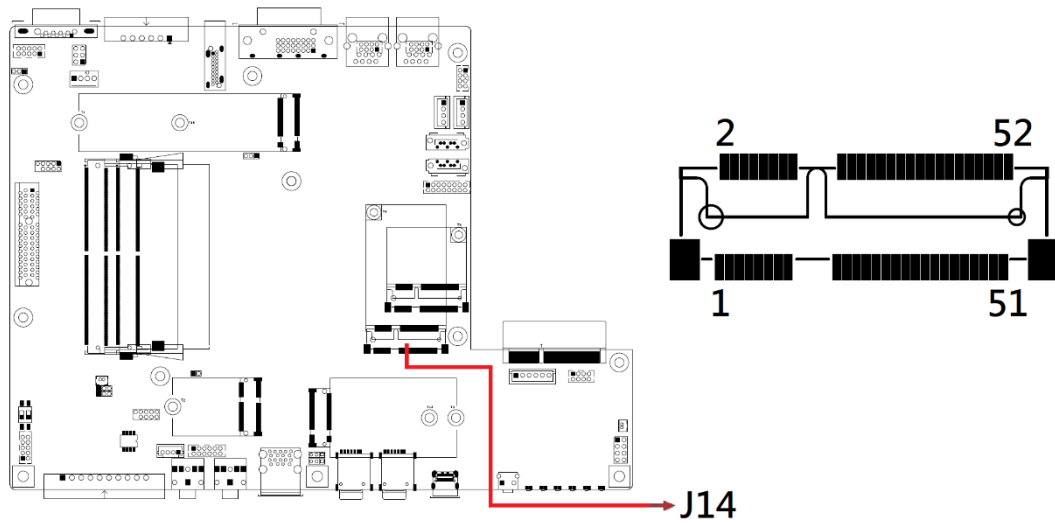

2.5.33 J15: Signals for the Power Board

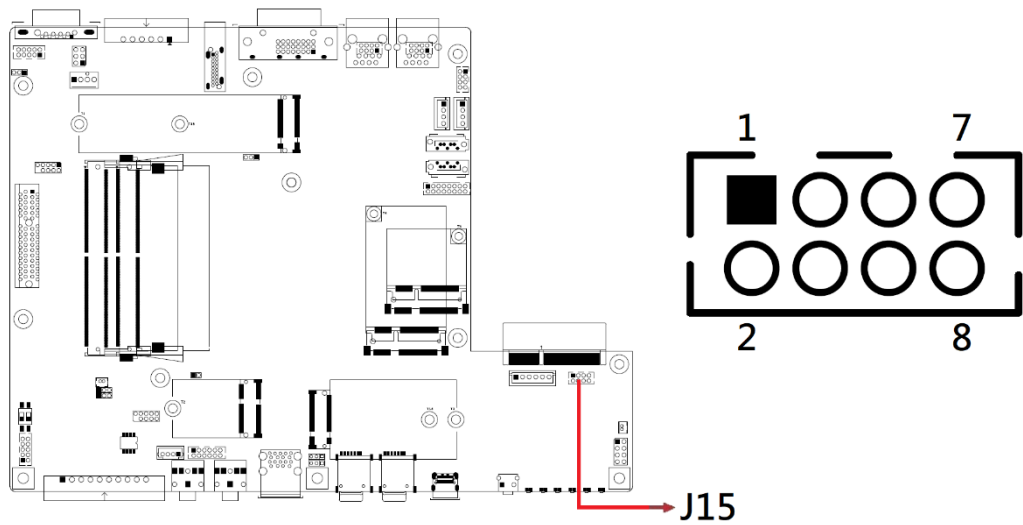

Pin	Assignment	Pin	Assignment
1	GPIA	2	+5V
3	GPIB	4	USB-
5	GPOA	6	USB+
7	GPOB	8	GND

2.5.34 J16: Battery Connector

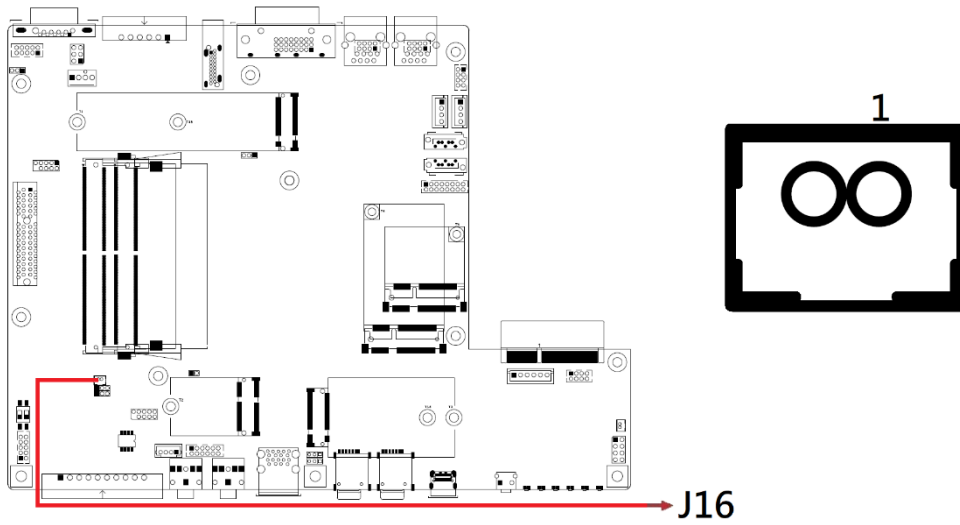

2.5.35 J17: M.2(E) 2230 (USB2.0/ PCIe x1) Connector

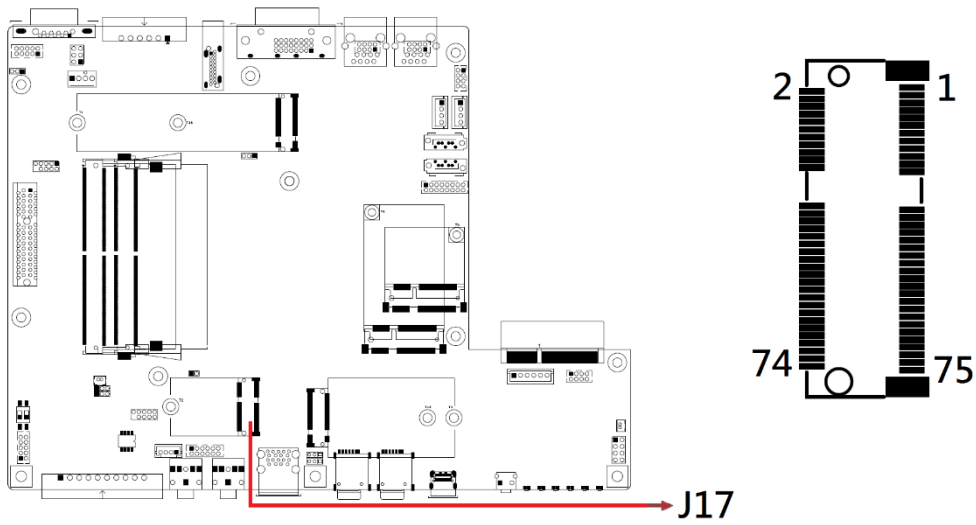

2.5.36 J18: SPI Flash Connector (Factory use only)

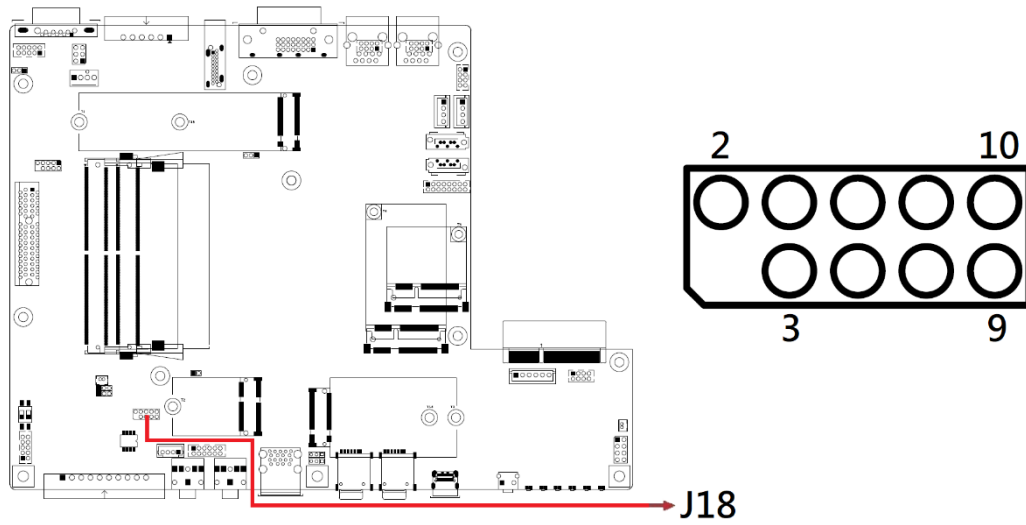

2.5.37 J19: M.2(B) 3042/52 Connector (PCIe x1 / USB 3.0)



2.5.38 J20: Power Button Pin Header

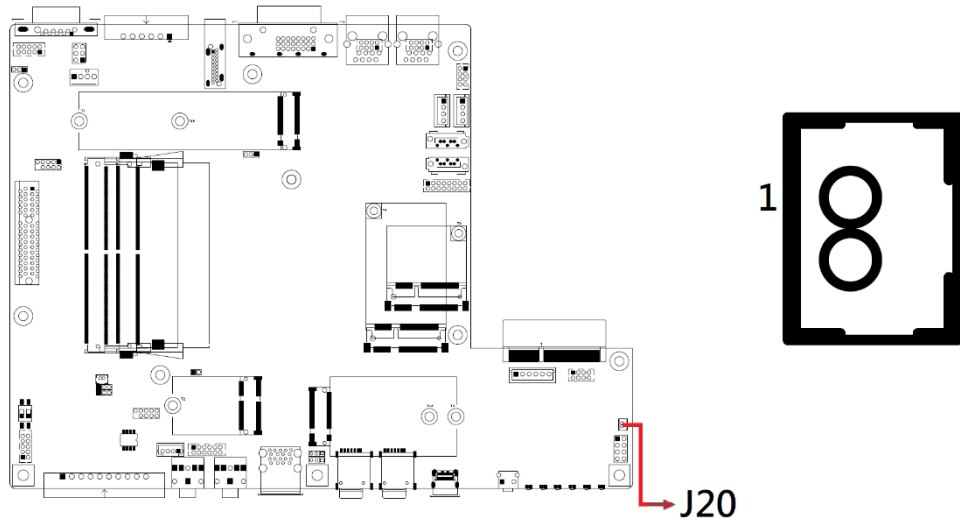

2.5.39 LED1, LED2, LED3, LED4, LED5, LED6

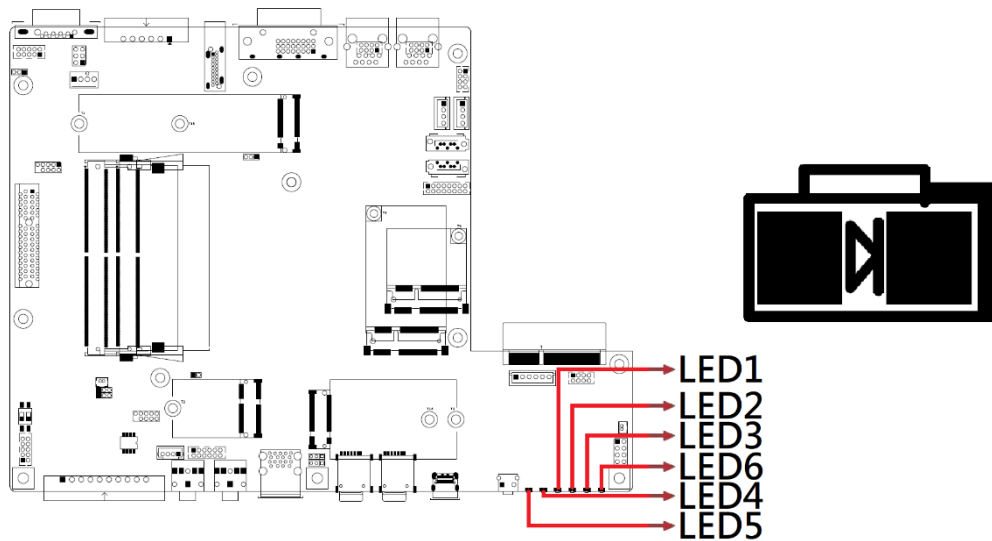

LED	Assignment
LED1	WWAN LED (amber color)
LED2	WLAN LED (blue color)
LED3	Storage LED (white color)
LED4	FP1(white color)
LED5	FP2(white color)
LED6	Power Status (green color)

2.5.40 LED7, LED8, LED9, LED10

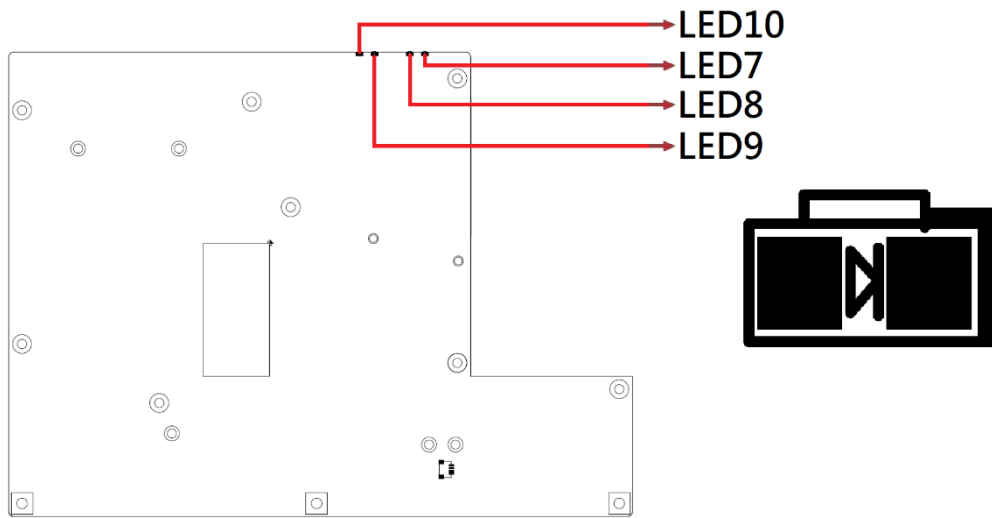

LED	Assignment
LED7	Link 2.5G (yellow color)
LED8	Link/active LED (green color)
LED9	Link 2.5G (yellow color)
LED10	Link/active Led (green color)

Chapter 3

Driver Installation

The information provided in this chapter includes:

- Intel® Chipset Software Installation Utility
- Graphics Drivers Installation
- Realtek Audio Drivers Installation
- LAN Drivers Installation
- CANBus Drivers Installation
- Intel® ME Drivers Installation

3.1 Introduction

This section describes the installation procedures for software drivers. The drivers can be downloaded from the IBASE website.

Note: After installing your Windows operating system, you must install the Intel® Chipset Software Installation Utility first before proceeding with other drivers.

3.2 Intel® Chipset Software Installation Utility

The Intel® Chipset drivers should be installed first before the software drivers to install INF files for Plug & Play function for the chipset components. Follow the the steps below.

1. Visit the IBASE download page and navigate to your product's support section. Download the compressed driver package and copy it to your system. Double-click the file to extract its contents. Run the CDGuide to open the main driver interface. In the left navigation pane, click Intel, then select Intel® RaptorLake-P/PS/U Chipset Drivers on the right.



2. Click Intel(R) Chipset Software Installation Utility.



iBASE

- When the *Welcome* screen appears, click **Next**.

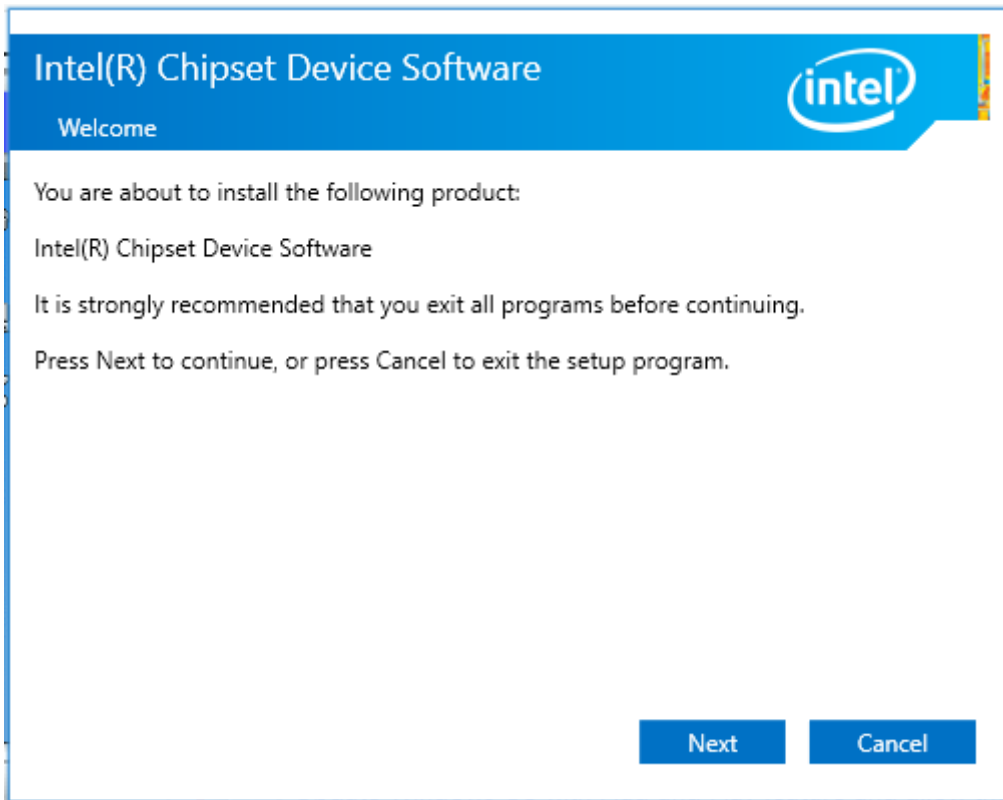

- Read and accept the license agreement.
- On the *Readme File Information* screen, click **Install**.

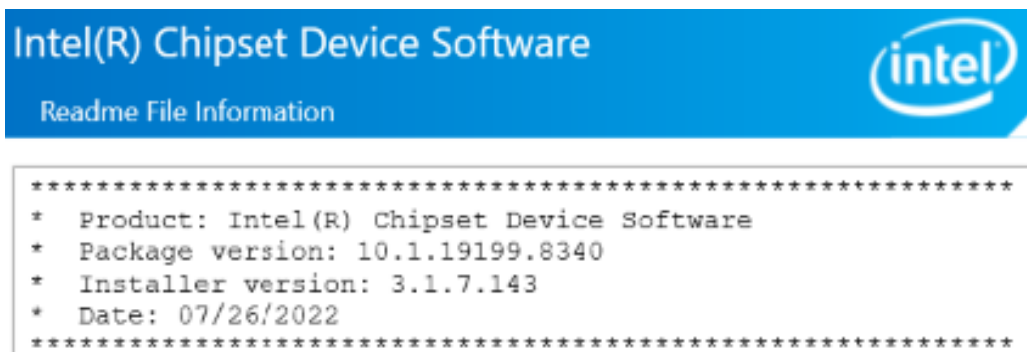

- When installaion is complete, click **Finish** to exit setup.

3.3 VGA Driver Installation

1. Click **Intel** on the left pane and then **Intel(R) RaptorLake-P/PS/U Chipset Drivers** on the right pane.
2. Click **Intel(R) HD Graphics Driver**.



3. Click **Begin installation**.

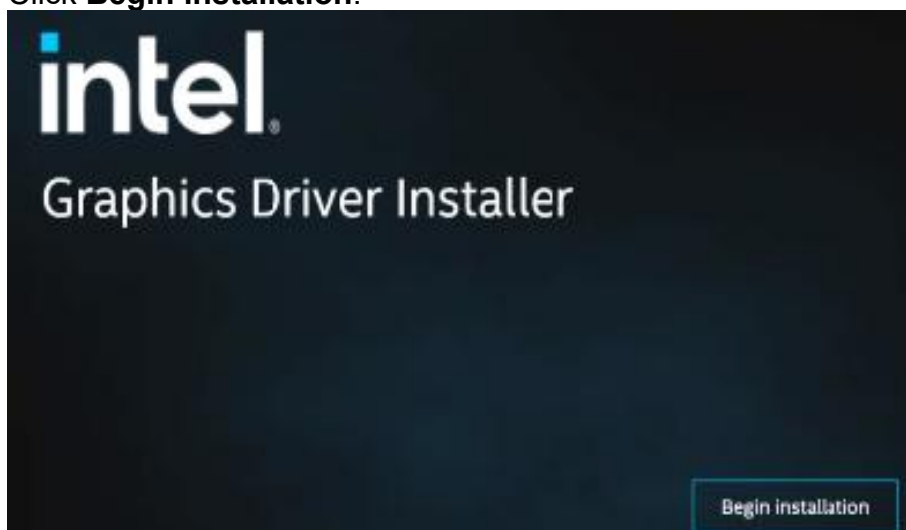

iBASE

4. Agree to the INTEL SOFTWARE LICENSE AGREEMENT.
5. Check the “Execute a clean installation” option. Click **Start** to begin installation.

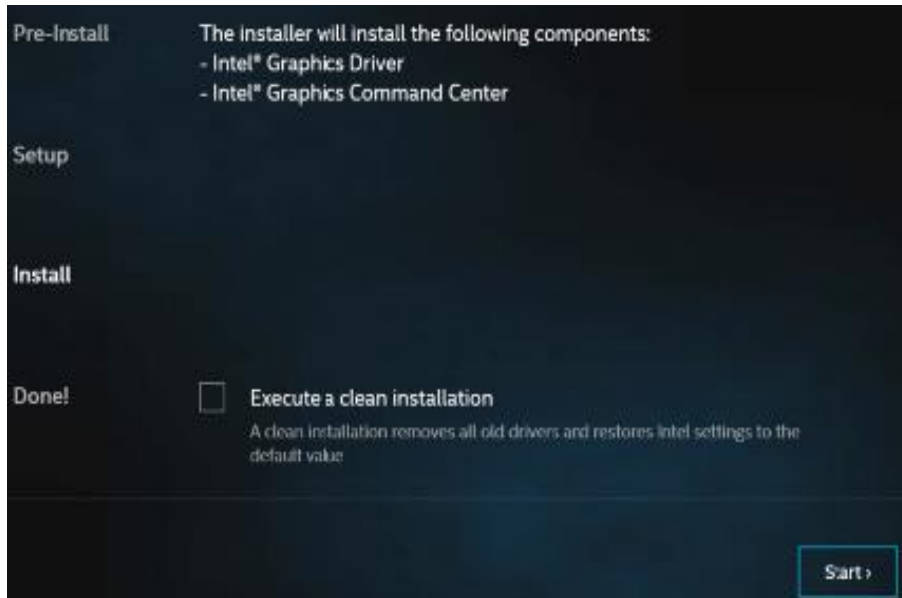

6. When the installation is completed, click **Finish**.

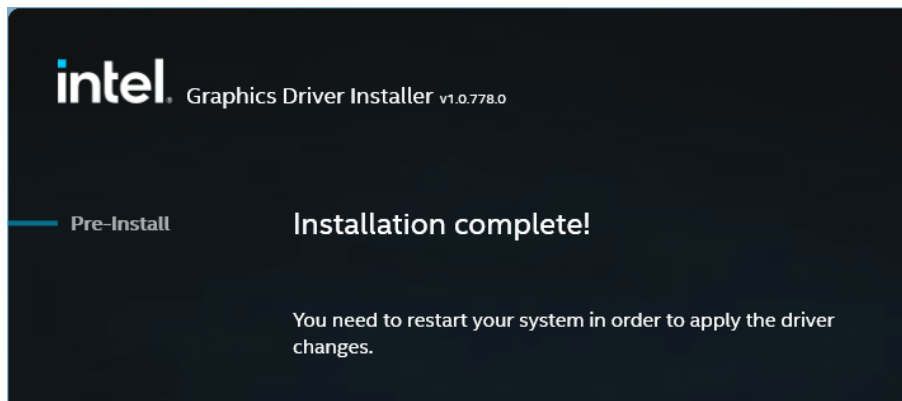

3.4 HD Audio Driver Installation

1. Click **Intel** on the left pane and then choose **Intel(R) RaptorLake-P/PS/U Chipset Drivers** on the right.
2. Click **Realtek Audio Drivers**.



3. Click **Realtek Audio DCH Drivers**.



4. On the *Welcome* screen of the InstallShield Wizard, click **Next**.

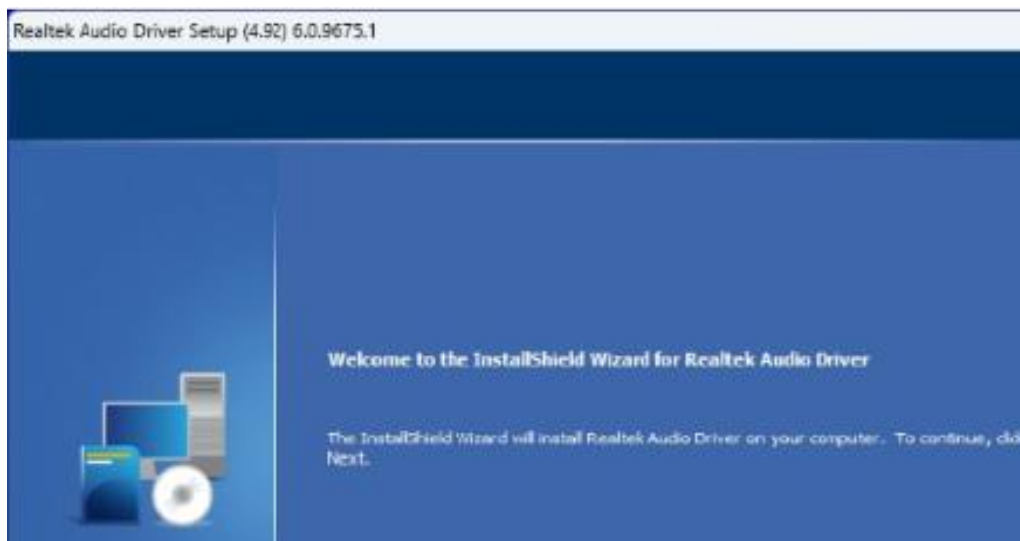

5. When installation is complete, click **Finish**.

3.5 LAN Driver Installation

1. Go to the Windows Device Manager as shown below and click choose Ethernet Controller.

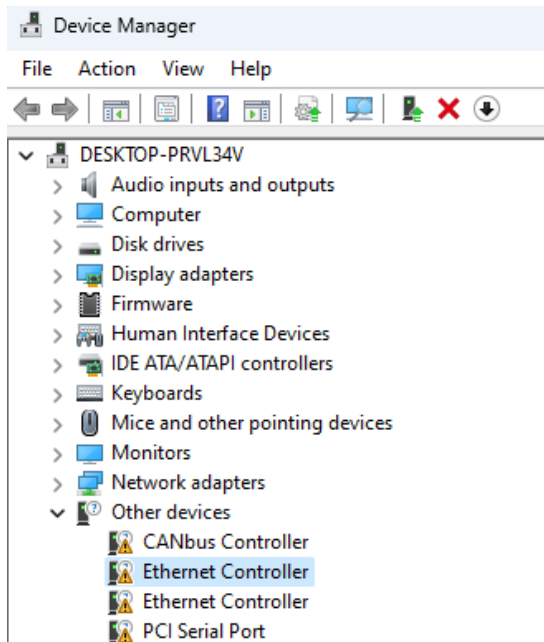

2. Click **Update Driver**.

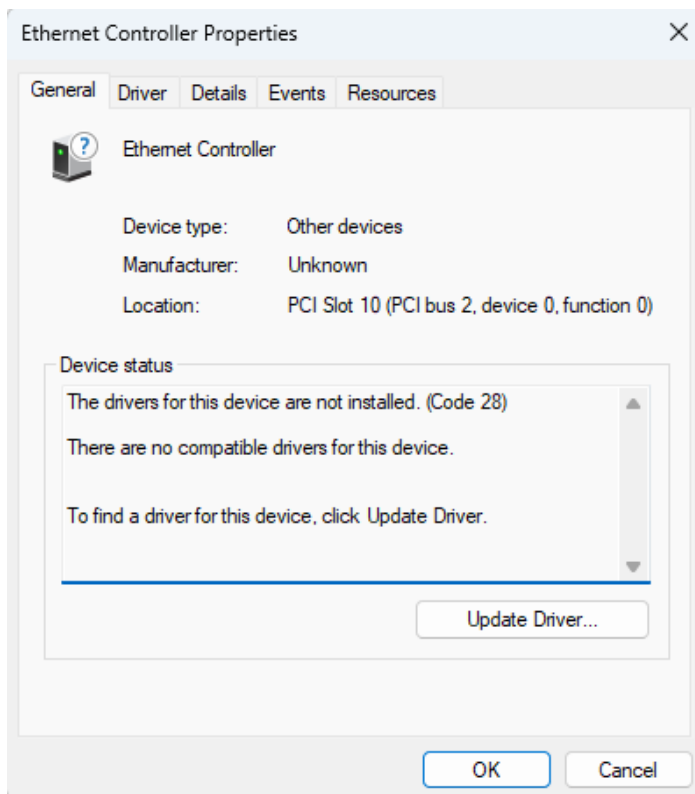

3. Choose **Update Driver** and click **OK**.

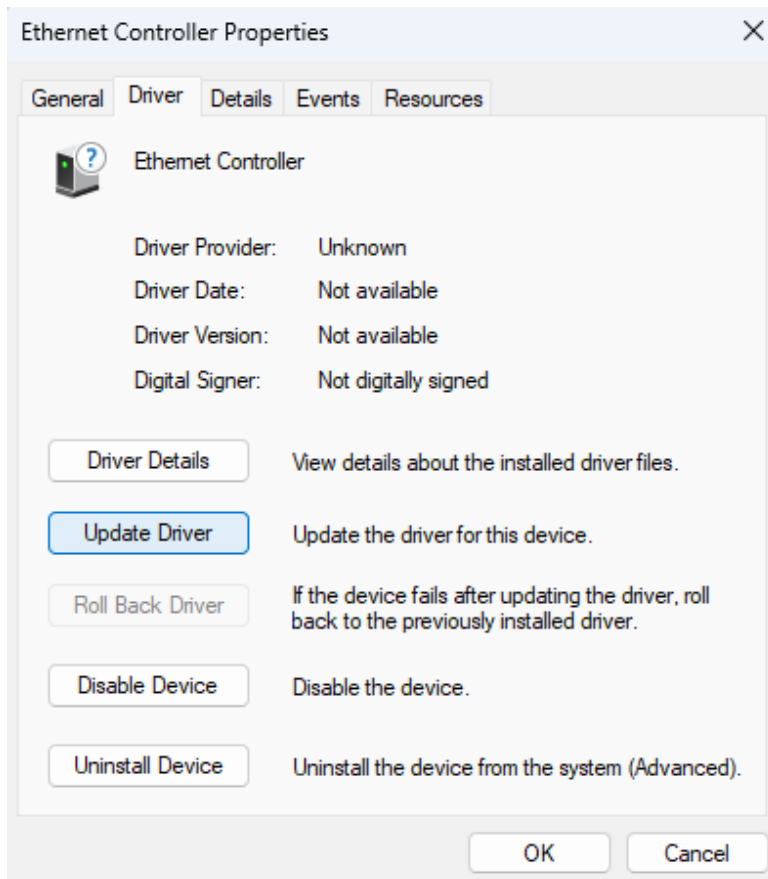

4. Browse for the drivers on your computer and click **Next** as shown below. The list will show available drivers compatible with the device, and all the drivers in the same category as the device. Proceed accordingly to finish the installation.

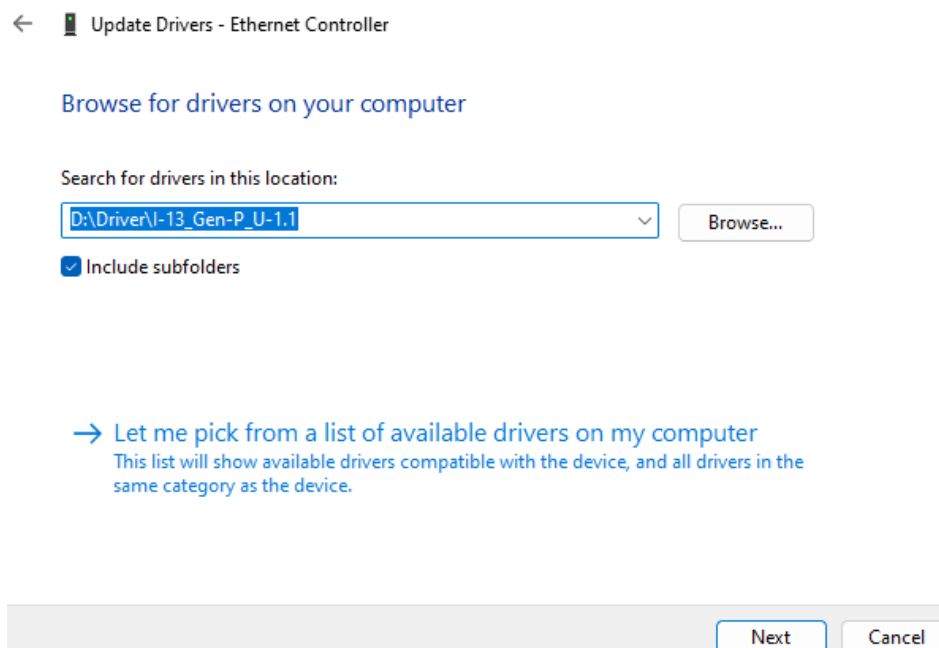

3.6 CANBus Driver Installation

1. Locate the CANBus driver files, as shown in the subdirectory below. Run the **Setup** file.

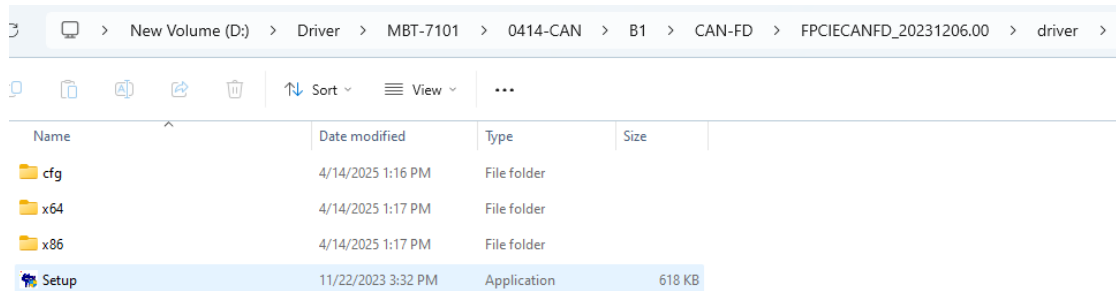

2. In the **Welcome** screen, click **Next** to start installing the drivers.

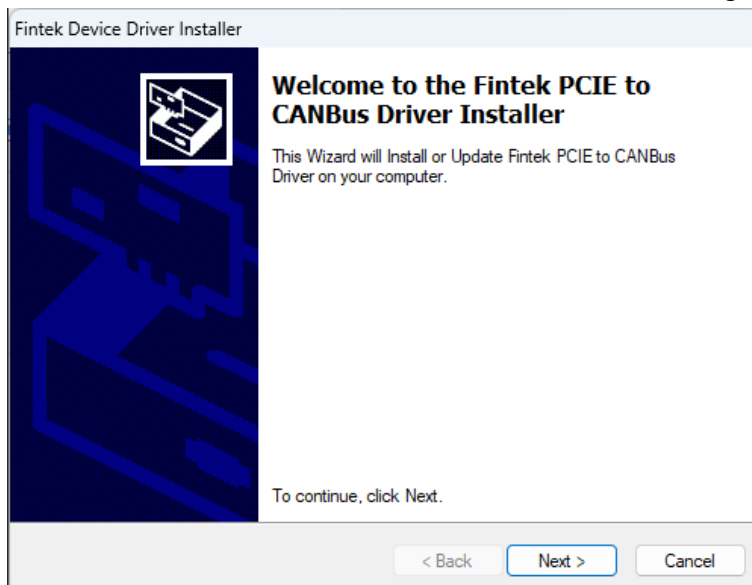

3. After the Wizard has finished the installation, click **Finish**.

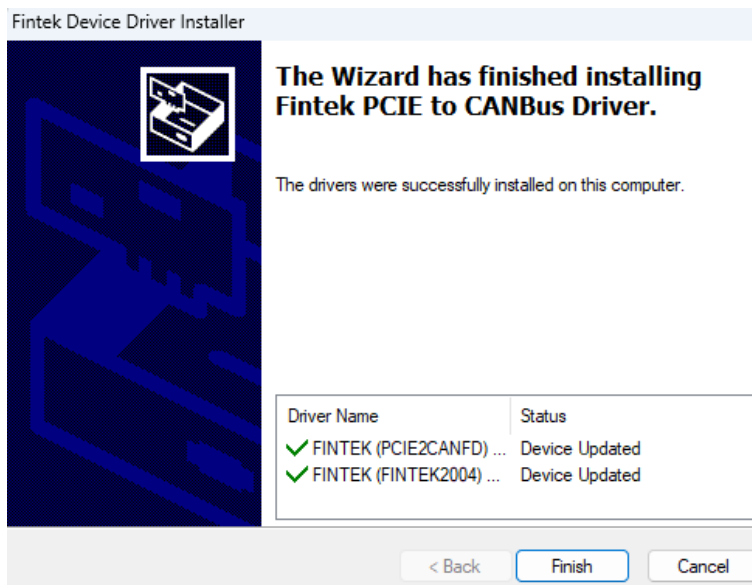

3.7 Intel® Management Engine Components Drivers Installation

1. Click **Intel** on the left pane and then select **Intel(R) RaptorLake-P/PS/U Chipset Drivers** on the right pane.
2. Click **Intel(R) ME Drivers**.



3. When the Welcome screen appears, click **Next**.

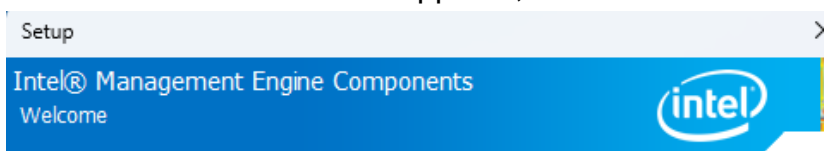

You are about to install the following product:

Intel® Management Engine Components 2321.4.31.0

It is strongly recommended that you exit all programs before continuing.
Click Next to continue, or click Cancel to exit the setup program.

4. Accept the terms in license agreement, then click **Next**.
5. In the Destination Folder screen, click **Next** to install to the default folder, or click Change to choose another destination folder.

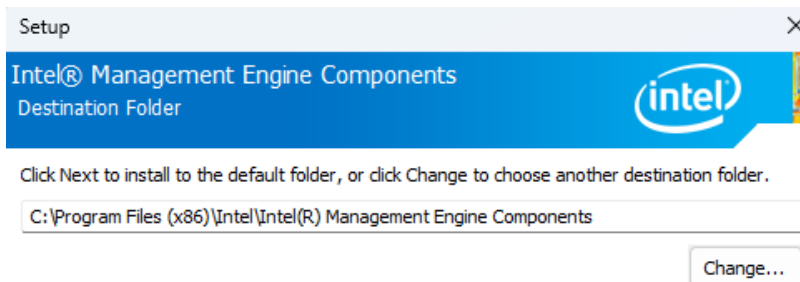

Click Next to install to the default folder, or click Change to choose another destination folder.

6. After installation is complete, click **Finish** to exit the setup.

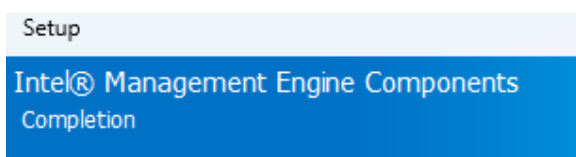

You have successfully installed the following components:

- Intel® Management Engine Interface
- Serial Over LAN
- Intel® Wireless Manageability Driver
- Local Management Service
- Intel® Dynamic Application Loader
- Intel® Trusted Connect Service

Chapter 4

BIOS Setup

This chapter describes the different settings available in the AMI BIOS that comes with the board. The topics covered in this chapter are as follows:

- Main Settings
- Advanced Settings
- Security Settings
- Boot Settings
- Save & Exit

4.1 Introduction

The BIOS (Basic Input/Output System) stored in the ROM of your computer system provides low-level control and initialization for Intel® processors. It supports standard devices such as disk drives, serial ports, and parallel ports. The BIOS also includes password protection and advanced options for fine-tuning the system chipset for maximum performance and stability.

4.2 BIOS Setup

The BIOS includes a Setup utility for configuring system settings. This utility is stored in the system's ROM and is activated as soon as the system is powered on.

To enter the BIOS Setup utility, press the key immediately after turning on the computer. If you wait too long, the system will proceed with POST (Power-On Self-Test), and you will need to restart in order to access Setup.

If you miss the timing:

- Press the **Reset** button, or
- Simultaneously press <Ctrl> + <Alt> + <Delete>, or
- Power the system off and back on again.

When starting up, you will see the message:

Press to Enter Setup

Within the BIOS Setup utility:

- Use the **arrow keys** to navigate,
- Press <Enter> to select,
- Use <PgUp> and <PgDn> to change values,
- Press <F1> for help,
- And <Esc> to exit.

The first screen you will see is the **Main Menu**, where you can access various configuration settings and exit options.

⚠ Warning:

It is strongly recommended that you do **not** modify the chipset default settings. These defaults have been carefully selected by AMI and your system manufacturer to ensure optimal performance and stability. Changing them may cause the system to become unstable or crash.

4.3 Main Settings

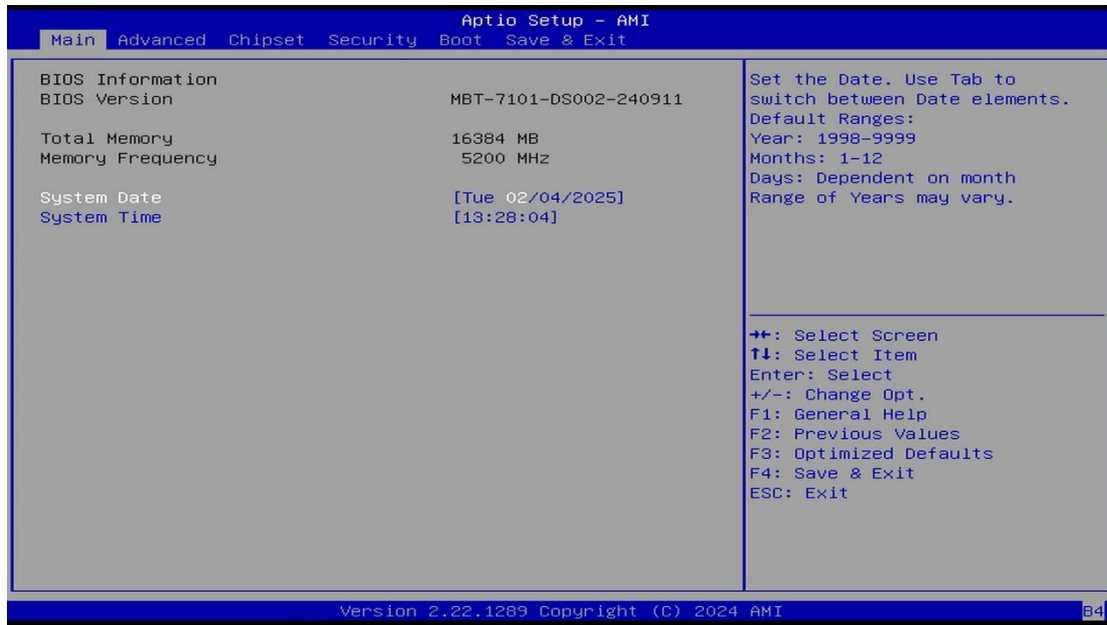

BIOS Setting	Description
System Date	Sets the date. Use the <Tab> key to switch between the data elements.
System Time	Set the time. Use the <Tab> key to switch between the data elements.

4.4 Advanced Settings

This section allows you to configure, improve your system and allows you to set up some system features according to your preference.

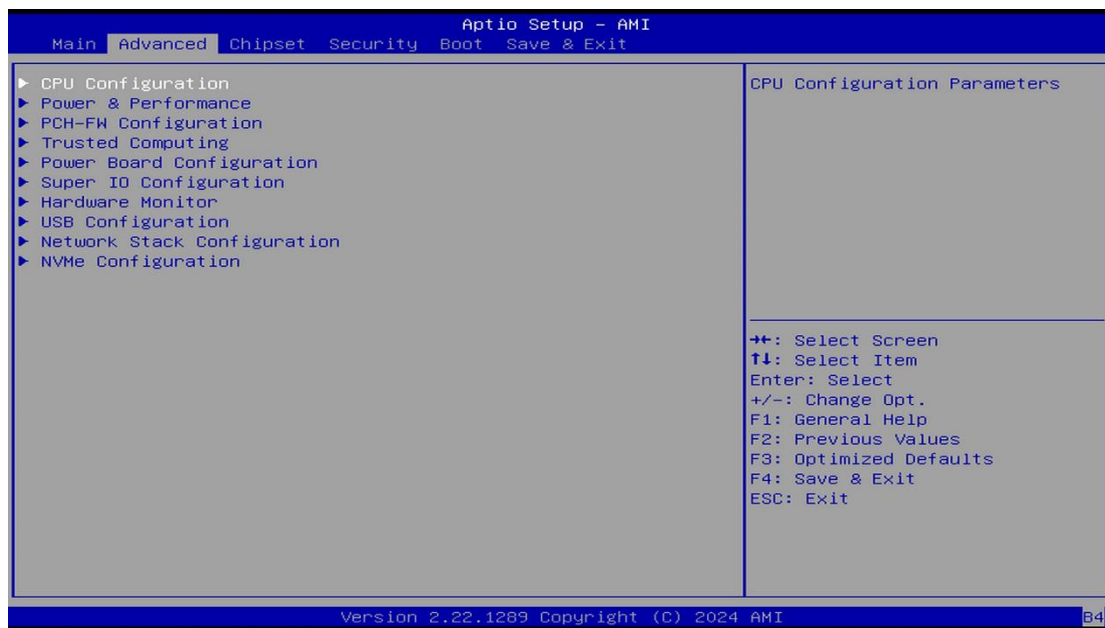

4.4.1 CPU Configuration

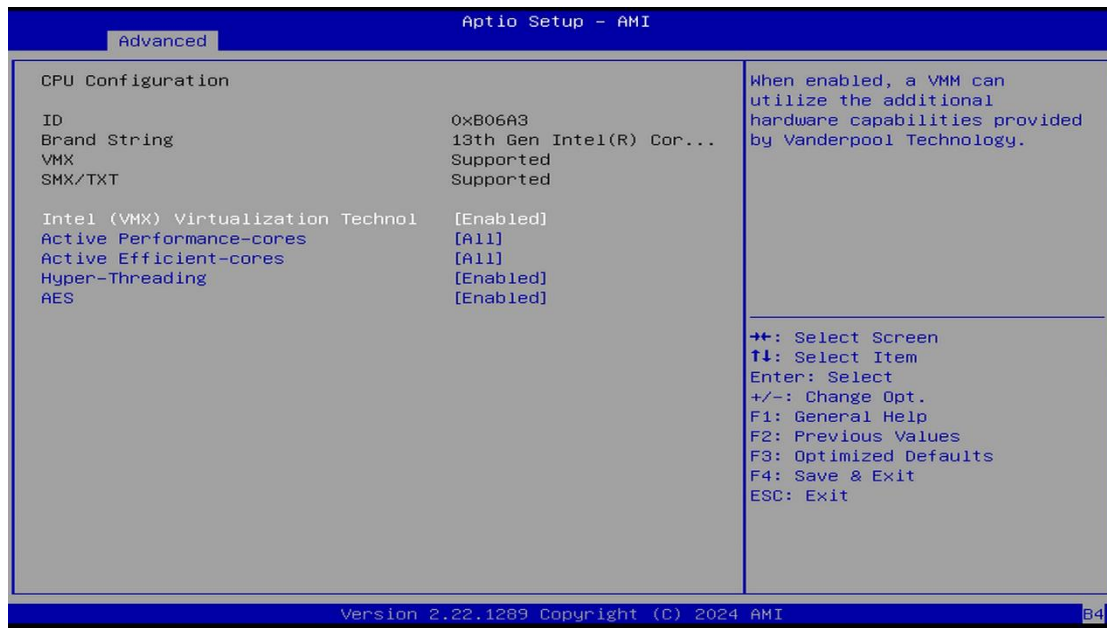

BIOS Setting	Description
Intel (VMX) Virtualization Technology	When enabled, a VMM can utilize the additional hardware capabilities provided by Vanderpool Technology.
Active Performance-cores Active Efficient-cores	Number of P-cores to enable in each processor package. Note: Number of Cores and E-cores are looked at together. When both are (0,0), Pcode will enable all cores
Hyper-Threading	Enable or disable Hyper-Threading Technology.
AES	Enable/Disable AES (Advanced Encryption Standard)

4.4.2 Power & Performance



BIOS Setting	Description
CPU – Power Management Control	CPU – Power Management Control Options

4.4.3 PCH-FW Configuration

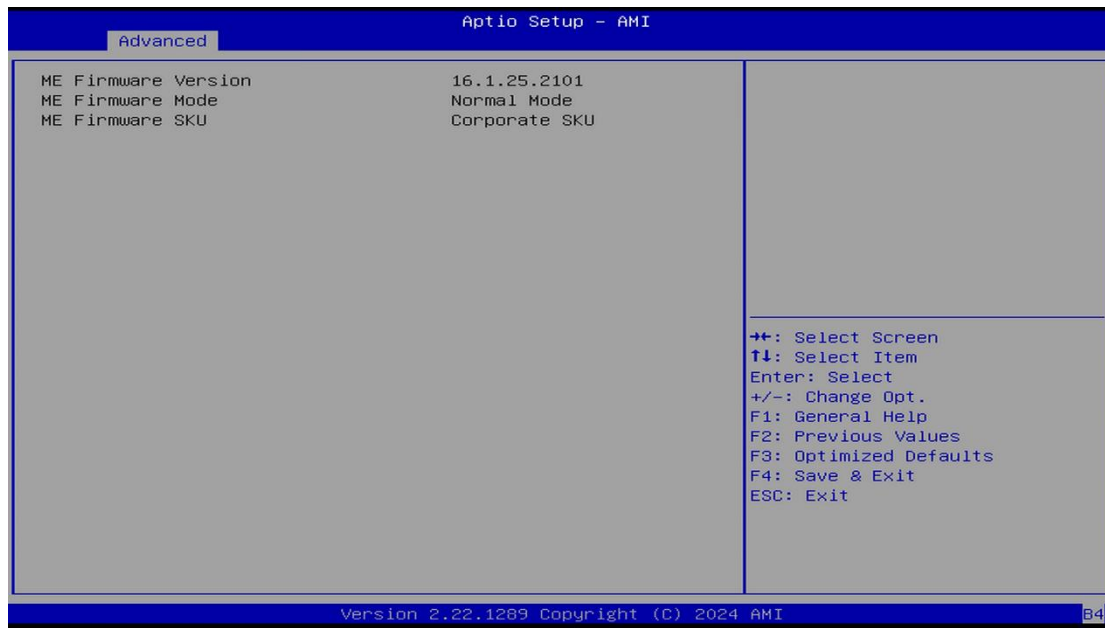

4.4.4 Trusted Computing



BIOS Setting	Description
Security Device Support	Enables / Disables BIOS support for security device. The OS will not show security device. TCG EFI protocol and INTIA interface will not be available.
SHA256 / SHA384 Bank	Option: Enabled / Disabled
Pending operation	Schedule an operation for the security device. Note: Your computer will reboot to change state of security device.
Platform Hierarchy	Enables / Disables platform hierarchy.
Storage Hierarchy	Enables / Disables storage hierarchy.
Endorsement Hierarchy	Enables / Disables endorsement hierarchy.
Physical Presence Spec Version	Selects to show the PPI Spec Version (1.2 or 1.3) that the OS supports. Note: Some HCK tests might not support 1.3.
Device Select	<ul style="list-style-type: none"> • TPM 1.2 will restrict support to TPM 1.2 devices only. • TPM 2.0 will restrict support to TPM 2.0 devices only. • Auto will support both with the default being set to TPM 2.0 devices if not found, and TPM 1.2 device will be enumerated.

4.4.5 Power Board Configuration

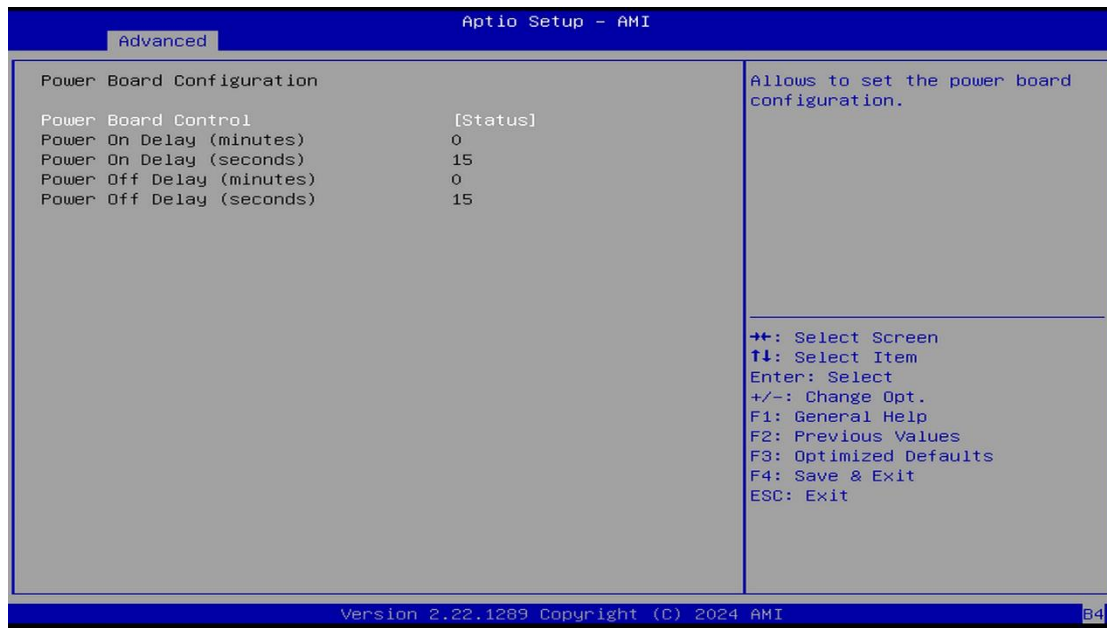

BIOS Setting	Description
Power Board Delay Control	Allows to set the delay timer for turning on or off the power board.
Power On Delay (minutes) / (seconds)	Sets the power-on-delay timer for minutes / seconds.
Power Off Delay (minutes) / (seconds)	Sets the power-off-delay timer for minutes / seconds.

4.4.6 Super IO Configuration

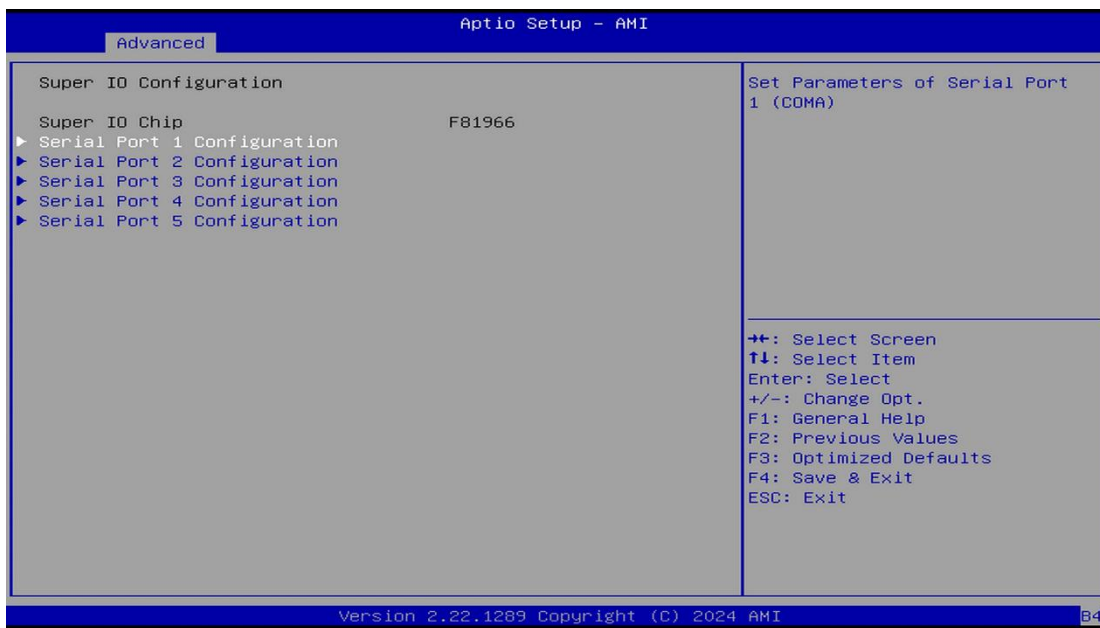

BIOS Setting	Description
Serial Port Configuration	Configures serial ports. You can enable / disable the serial port and select an optimal settings for the Super IO device.

4.4.6.1. Serial Port 1 Configuration

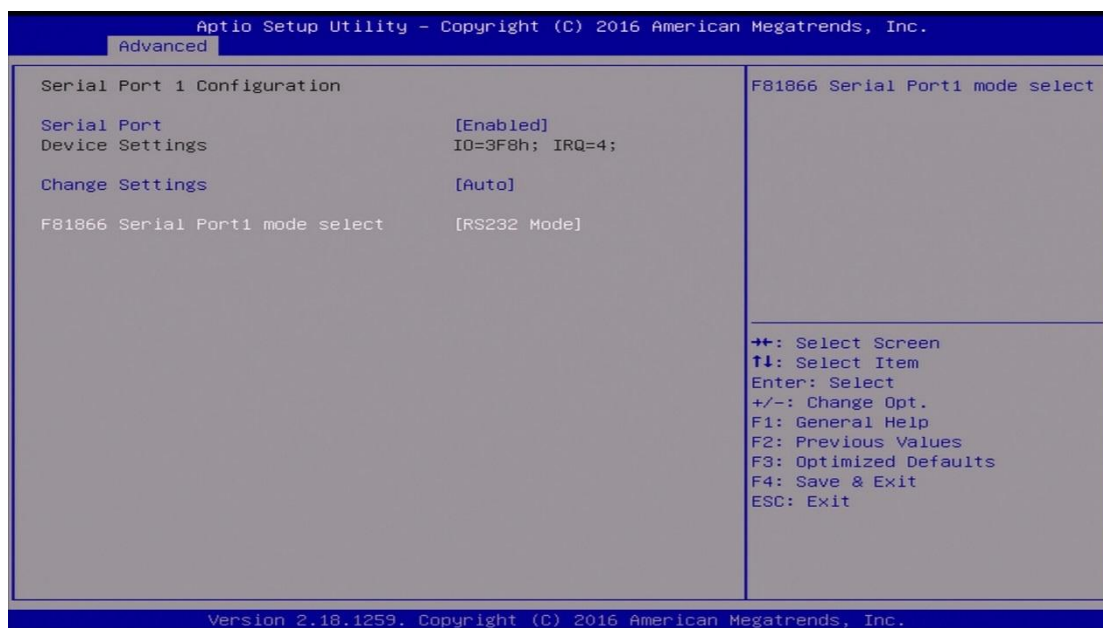

BIOS Setting	Description
Serial Port	Enables / Disables the serial port (COM).
Change Settings	Selects an optimal settings for the Super I/O device.
F81866 Serial Port1 Mode Select	Changes the mode of serial port.

4.4.6.2. Serial Port 2 Configuration

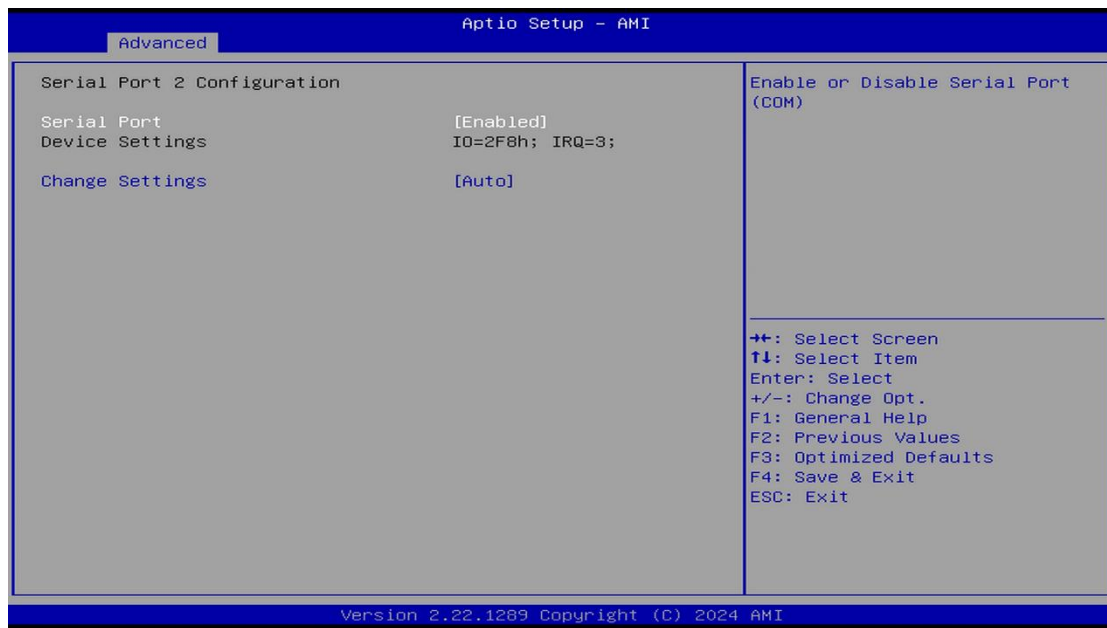

BIOS Setting	Description
Serial Port	Enables / Disables the serial port (COM).
Change Settings	Selects an optimal setting for the Super I/O device.

4.4.6.3. Serial Port 3 Configuration

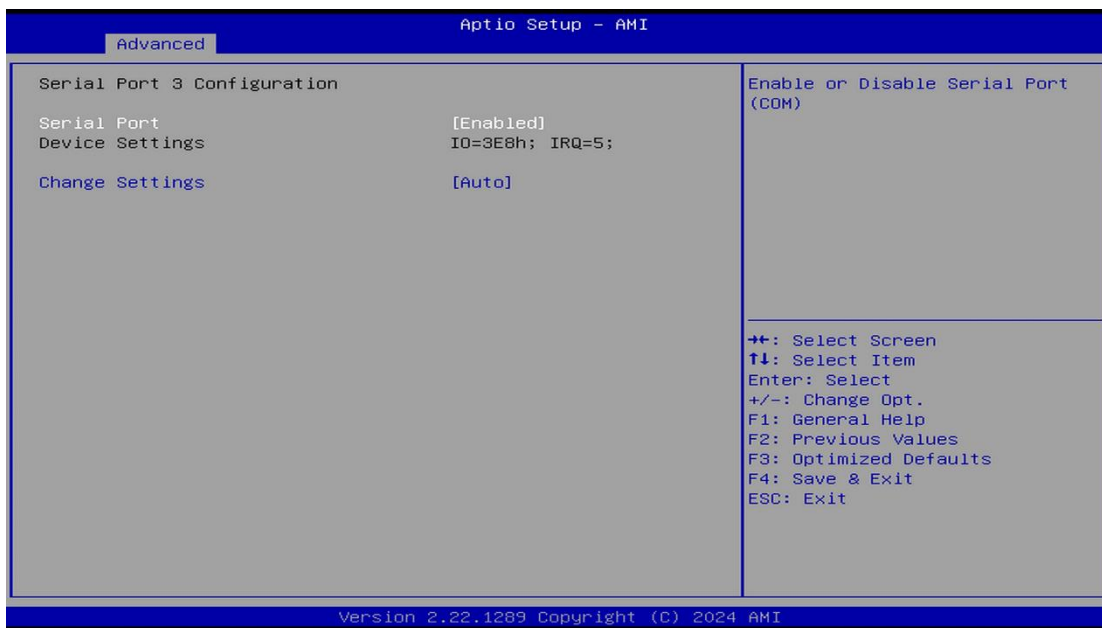

BIOS Setting	Description
Serial Port	Enables / Disables the serial port (COM).
Change Settings	Selects an optimal setting for the Super I/O device.

4.4.6.4. Serial Port 4 Configuration

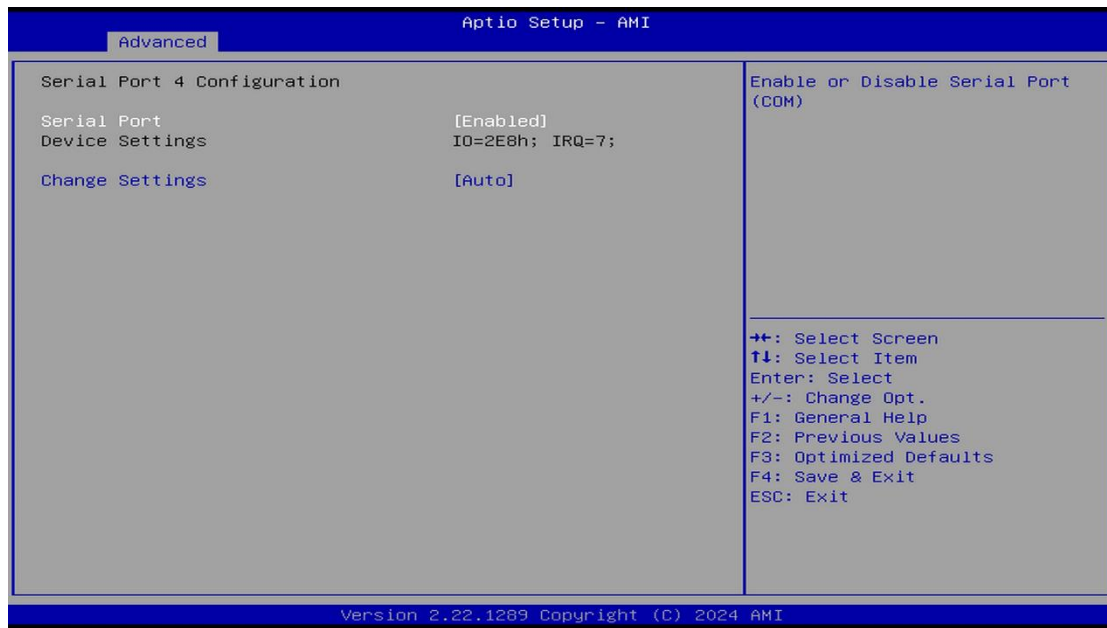

BIOS Setting	Description
Serial Port	Enables / Disables the serial port (COM).
Change Settings	Selects an optimal settings for the Super I/O device.

4.4.6.5. Serial Port 5 Configuration



BIOS Setting	Description
Serial Port	Enables / Disables the serial port (COM).
Change Settings	Selects an optimal settings for the Super I/O device.

4.4.7 Hardware Monitor

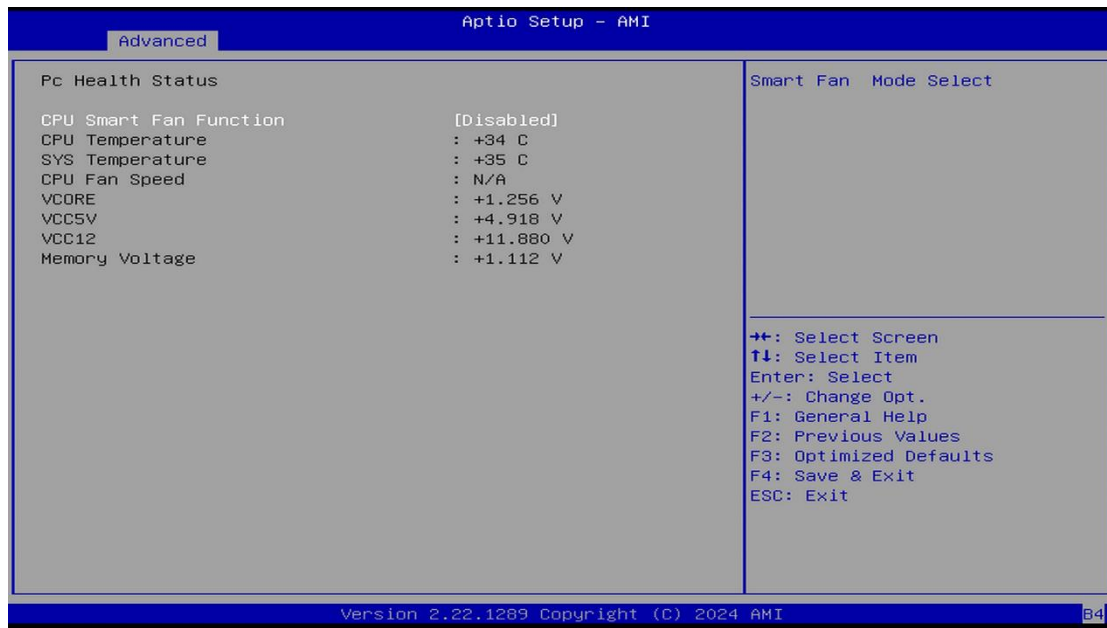

BIOS Setting	Description
CPU Smart Fan Function	Selects the Smart Fan Mode operating mode
Temperatures / Voltages	These fields are the parameters of the hardware monitoring function feature of the motherboard. The values are read-only values as monitored by the system and show the PC health status

4.4.8 Network Stack Configuration

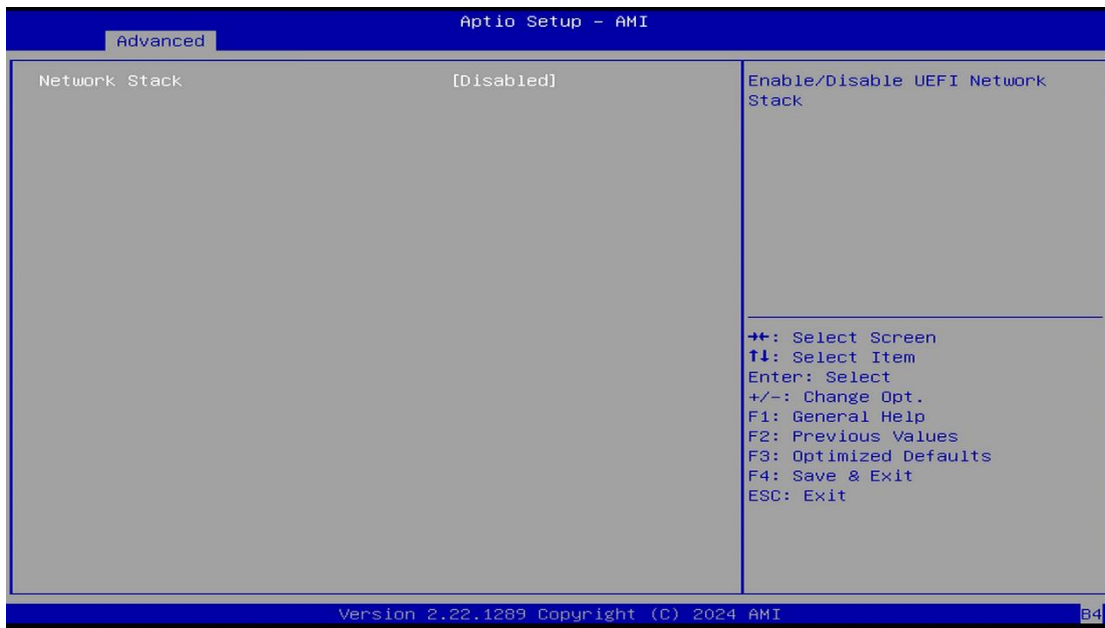

4.4.9 NVMe Configuration

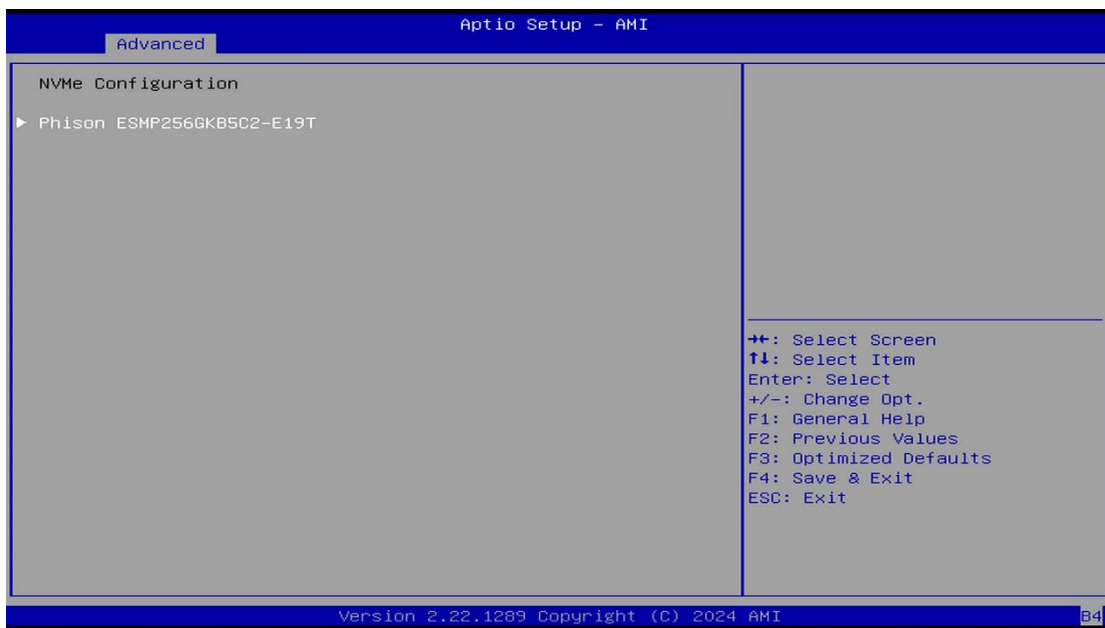

4.4.10 USB Configuration

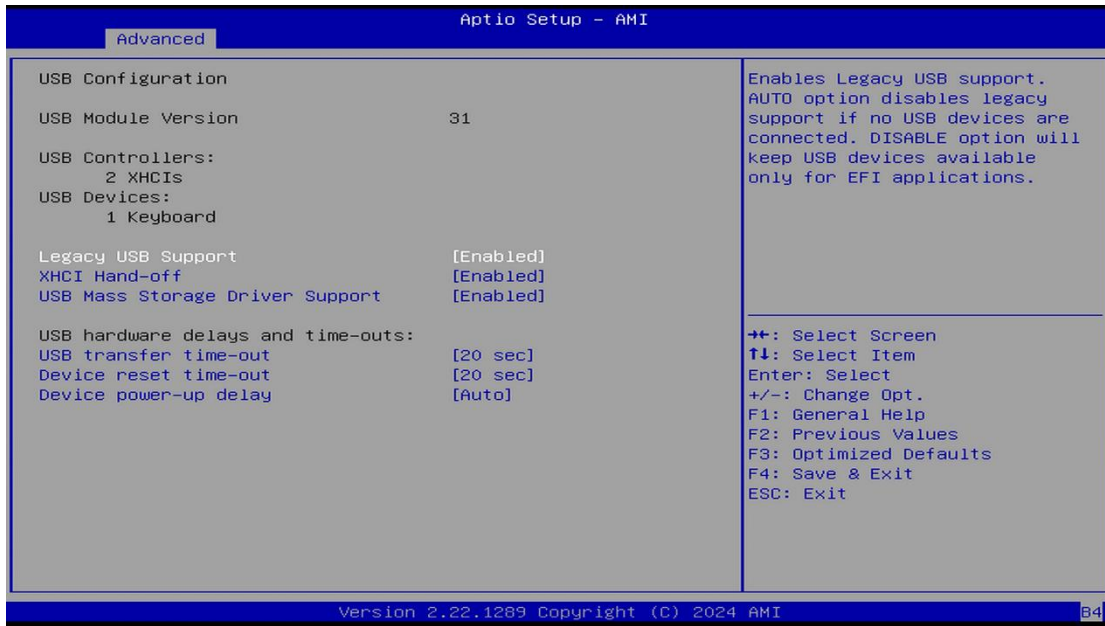

BIOS Setting	Description
Legacy USB Support	Enables / Disables Legacy USB support. <ul style="list-style-type: none"> • Auto disables legacy support if there is no USB device connected. • Disable keeps USB devices available only for EFI applications.
XHCI Hand-off	This is a workaround for OSEs without XHCI hand-off support. The XHCI ownership change should be claimed by XHCI driver.
USB Mass Storage Driver Support	Enables / Disables USB mass storage driver support.
USB Transfer time-out	Sets the time-out value 1, 5, 10 or 20 sec(s) for Control, Bulk, and Interrupt transfers.
Device reset time-out	Sets the seconds (10, 20, 30, 40 secs) of delaying execution of start unit command to USB mass storage device.
Device power-up delay	The maximum time the device will take before it properly reports itself to the Host Controller. Auto uses default value. For a Root port, it is 100 ms. For a Hub port, the delay is taken from Hub descriptor.

4.5 Chipset Settings

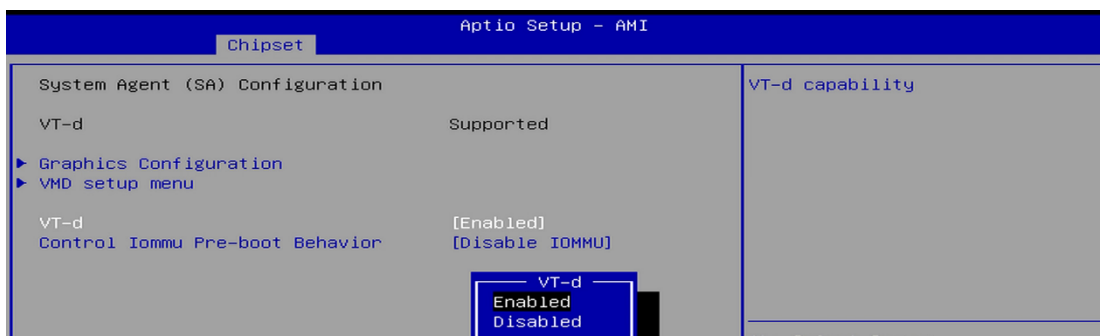
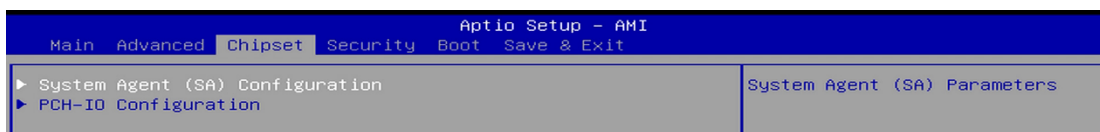

BIOS Setting	Description
System Agent (SA) Configuration	System Agent (SA) parameters
PCH-IO Configuration	PCH parameters

4.5.1 System Agent (SA) Configuration

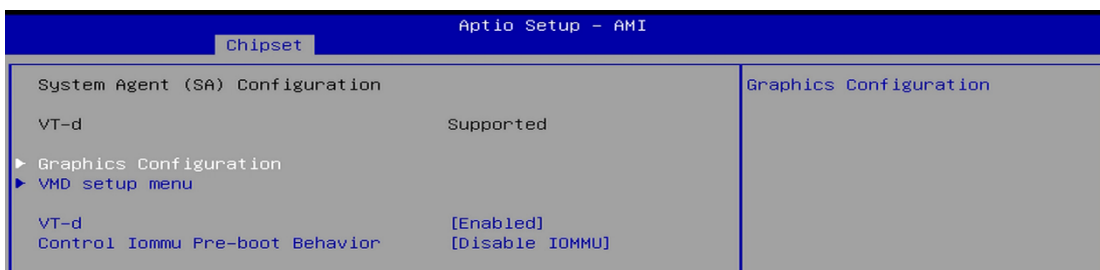

BIOS Setting	Description
Graphics Configuration	Configures the graphics settings.
VT-d	VT-d capability, Enabled/Disabled
Control Iommu Pre-boot Behavior	Default: Disable

4.5.1.1. Graphics Configuration

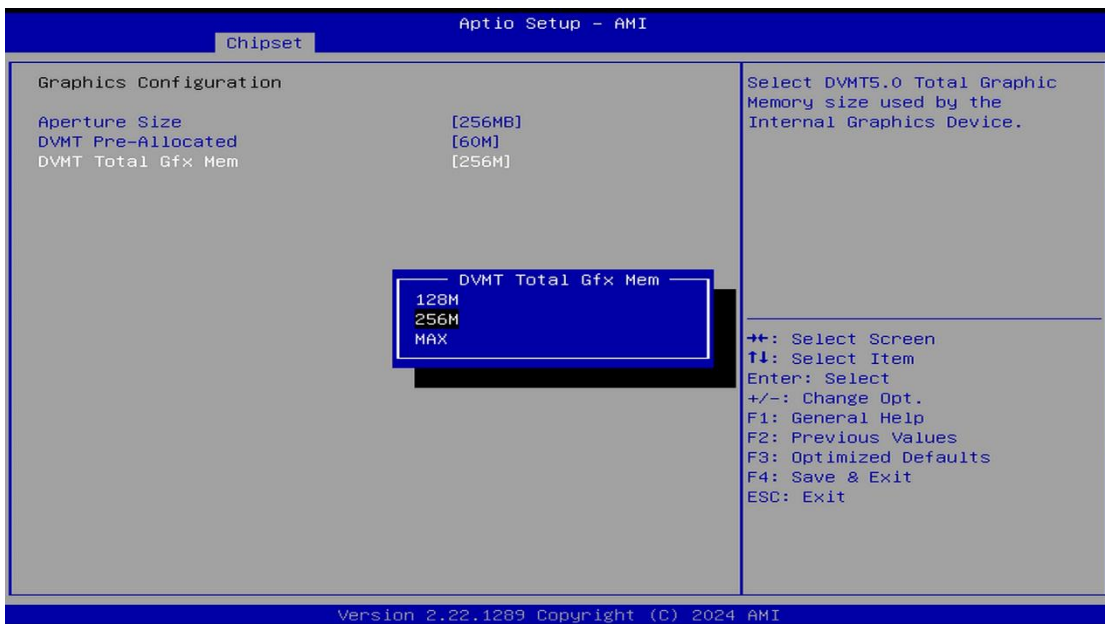
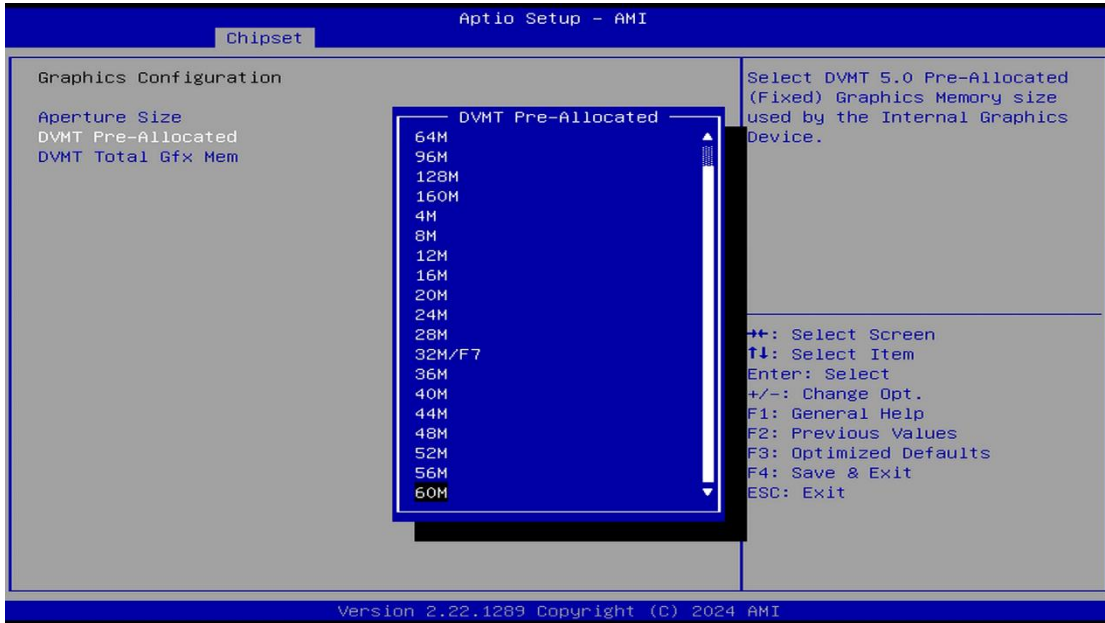
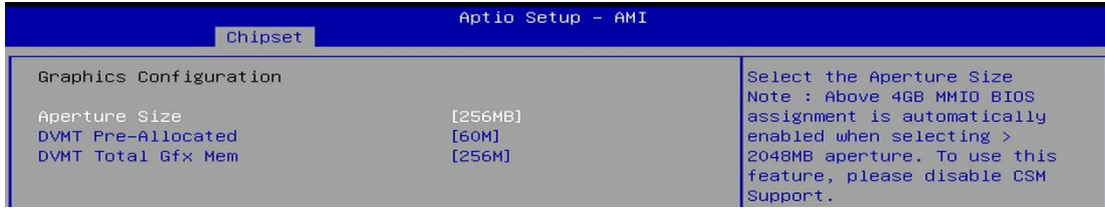

4.5.1.2. VMD Setup Menu

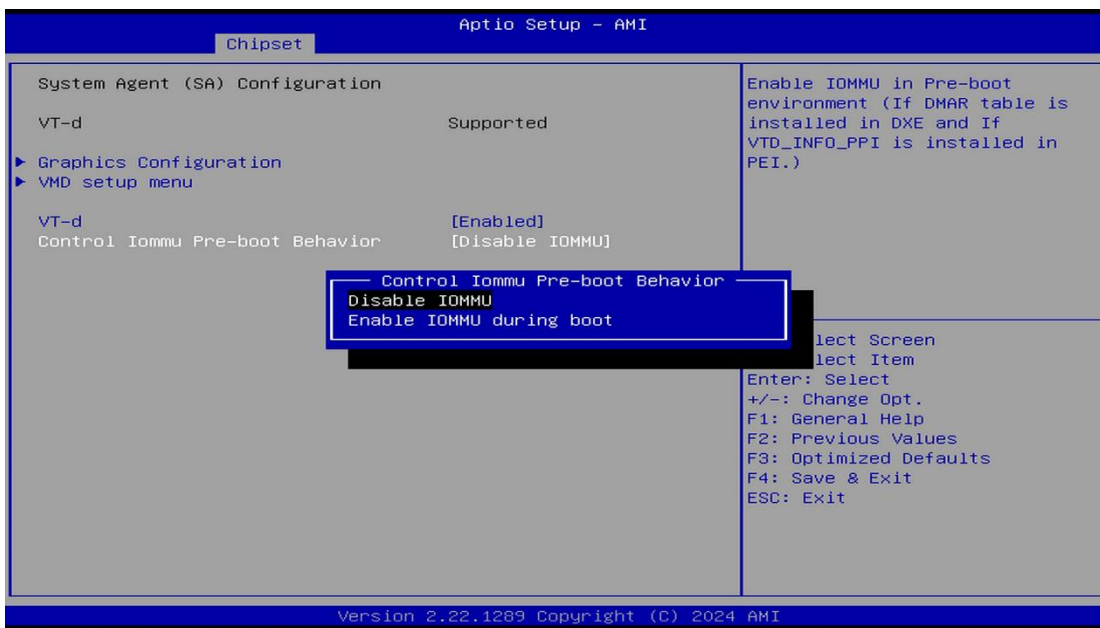
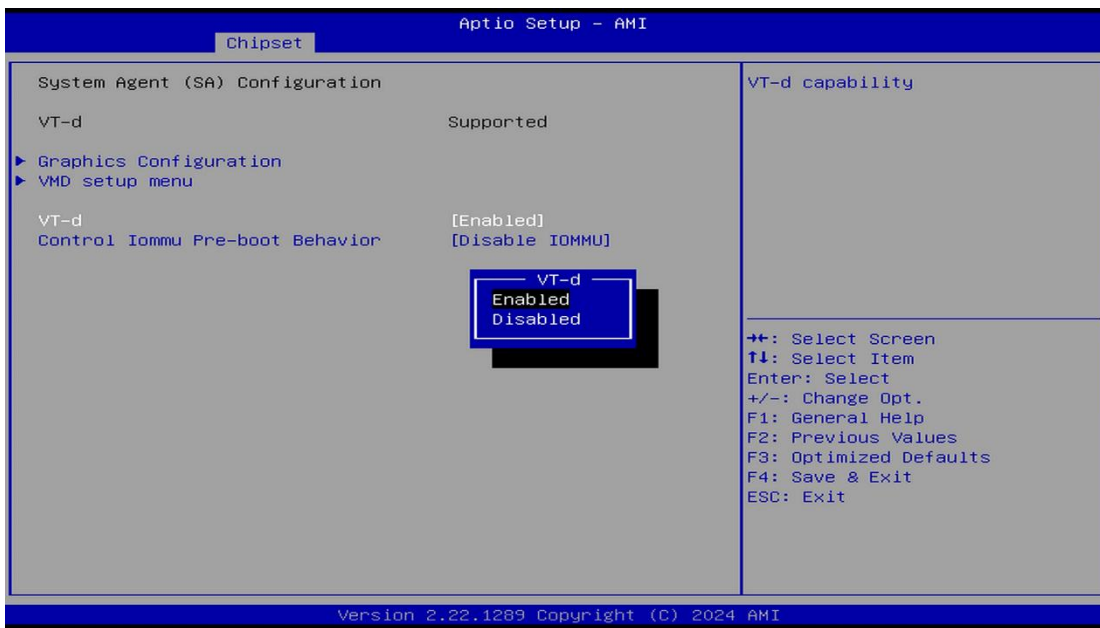

4.5.6 PCH-IO Configuration

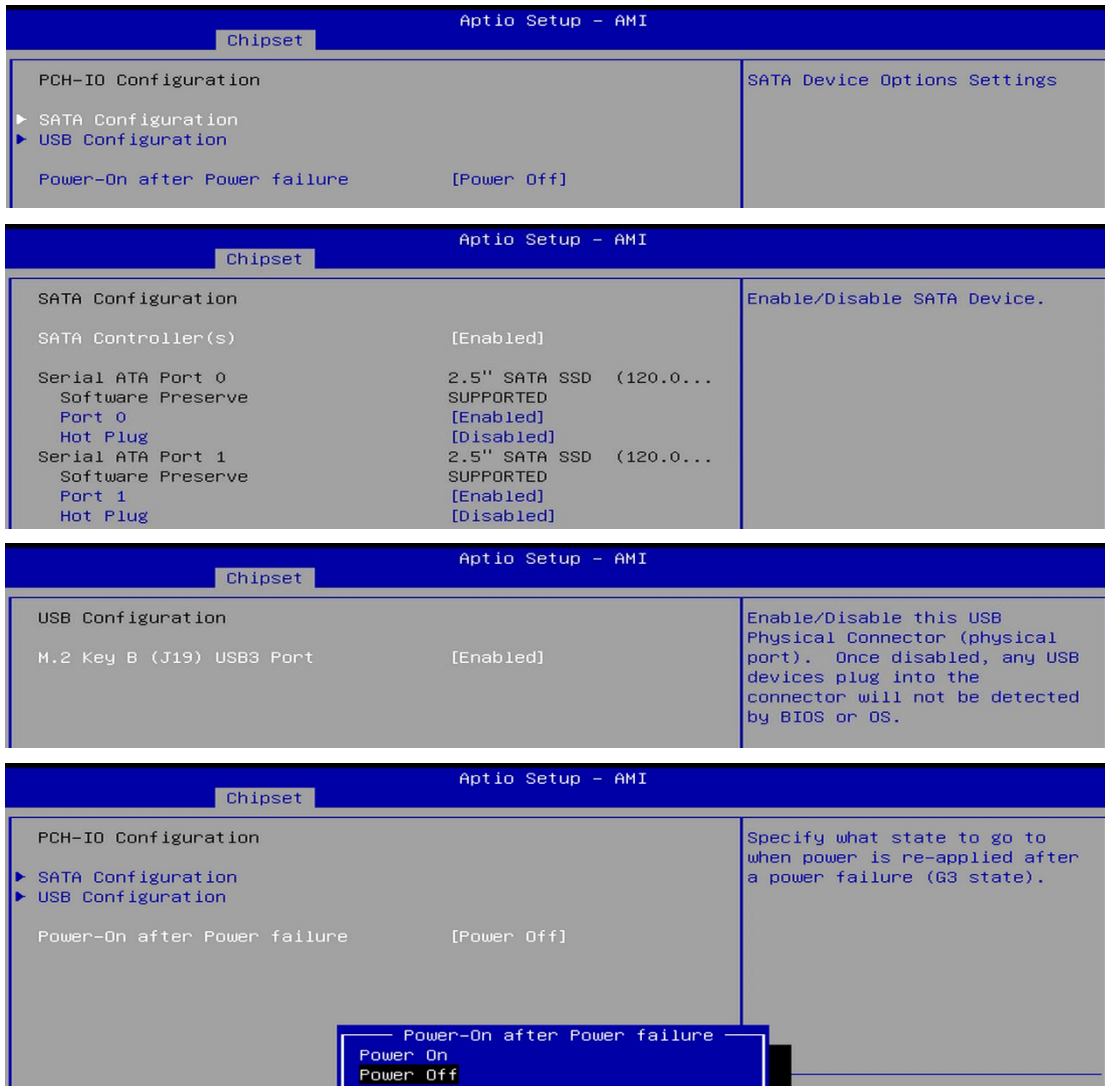

BIOS Setting	Description
SATA Controller(s)	Enables / Disables the SATA device.
Serial ATA Ports	Enables / Disables SATA ports.
Hot Plug	Designates the port as Hot Pluggable.
Power-On after Power failure	Specify what state to go to when power is re-applied after a power failure (S3 state)

4.6 Security Settings

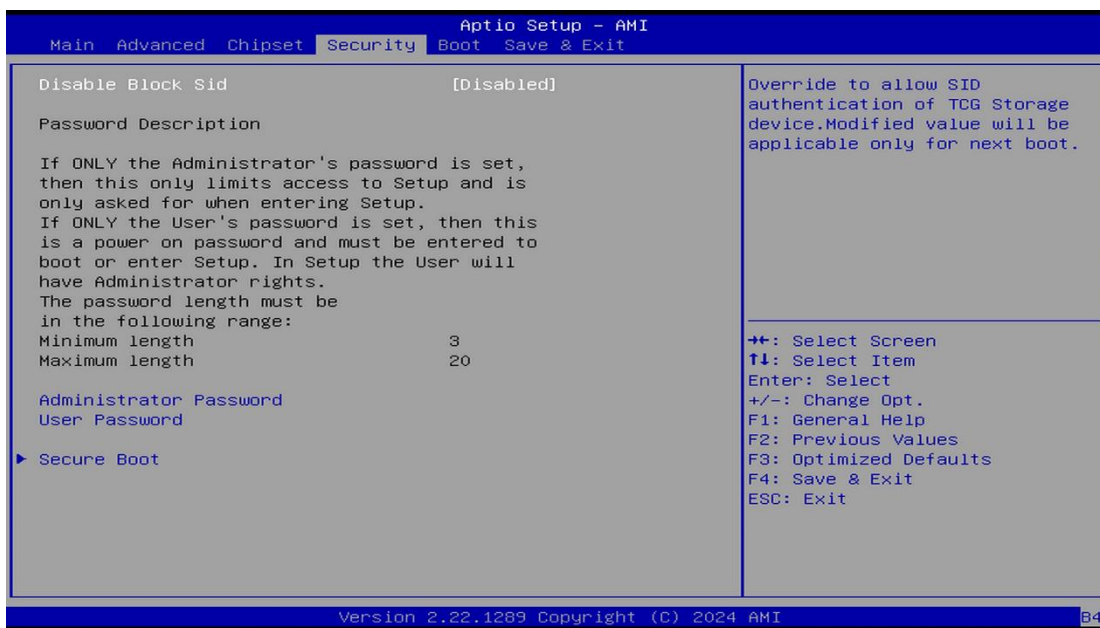

BIOS Setting	Description
Administrator Password	Sets an administrator password for the setup utility.
User Password	Sets a user password.
Secure Boot	Allows override for SID authentication of TCG storage device. Modified value will be applicable only for next boot.

4.6.1 Secure Boot

Aptio Setup - AMI

Security

System Mode	Setup	Secure Boot feature is Active if Secure Boot is Enabled, Platform Key(PK) is enrolled and the System is in User mode. The mode change requires platform reset
Secure Boot	[Disabled] Not Active	
Secure Boot Mode	[Custom]	
▶ Restore Factory Keys ▶ Reset To Setup Mode ▶ Key Management		

Vendor Keys	Valid	Install factory default Secure Boot keys after the platform reset and while the System is in Setup mode
Factory Key Provision	[Disabled]	
▶ Restore Factory Keys ▶ Reset To Setup Mode ▶ Enroll Efi Image ▶ Export Secure Boot variables		
Secure Boot variable	Size Keys Key Source	

▶ Platform Key (PK)	0 0 No Keys
▶ Key Exchange Keys (KEK)	0 0 No Keys
▶ Authorized Signatures (db)	0 0 No Keys
▶ Forbidden Signatures (dbx)	0 0 No Keys
▶ Authorized TimeStamps (dbt)	0 0 No Keys
▶ OsRecovery Signatures (dbr)	0 0 No Keys

↔: Select Screen
↑↓: Select Item
Enter: Select

Vendor Keys	Valid	Force System to User Mode. Install factory default Secure Boot key databases
Factory Key Provision	[Disabled]	
▶ Restore Factory Keys ▶ Reset To Setup Mode ▶ Enroll Efi Image ▶ Export Secure Boot variables		
Secure Boot variable	Size Keys Key Source	

▶ Platform Key (PK)	Install factory defaults
Press 'Yes' to proceed 'No' to cancel	
Yes	No

↔: Select Screen
↑↓: Select Item
Enter: Select

Vendor Keys	Valid	Allow Efi image to run in Secure Boot mode. Enroll SHA256 Hash certificate of a PE image into Authorized Signature Database (db)
Factory Key Provision	[Disabled]	
▶ Restore Factory Keys ▶ Reset To Setup Mode ▶ Enroll Efi Image		
Secure Boot variable	Size Keys Key Source	

Select a File system

```
PciRoot(0x0)/Pci(0x6,0x0)/Pci(0x0,0x0)/NVMe(0x1,16-1C-50-BA-87-A7-79-64)/HD(1,GPT,D3963973-946
PciRoot(0x0)/Pci(0x6,0x0)/Pci(0x0,0x0)/NVMe(0x1,16-1C-50-BA-87-A7-79-64)/HD(3,GPT,F07656F4-6E8
PciRoot(0x0)/Pci(0x6,0x0)/Pci(0x0,0x0)/NVMe(0x1,16-1C-50-BA-87-A7-79-64)/HD(4,GPT,EAA9AF81-3B3
PciRoot(0x0)/Pci(0x17,0x0)/Sata(0x0,0xFFFF,0x0)/HD(2,GPT,092E2EC9-726B-48CF-8379-64C780C344BD,
PciRoot(0x0)/Pci(0x17,0x0)/Sata(0x1,0xFFFF,0x0)/HD(1,GPT,86206FEB-5E0F-44EB-BD3F-D11F8E98EB7F,
PciRoot(0x0)/Pci(0x17,0x0)/Sata(0x1,0xFFFF,0x0)/HD(3,GPT,BBBE3401-512A-48F8-94FA-F91A5B517E91,
PciRoot(0x0)/Pci(0x17,0x0)/Sata(0x1,0xFFFF,0x0)/HD(4,GPT,4DE180CC-69A3-44F1-ACAD-9712255422EE,
```

Vendor Keys	Valid	Enroll Factory Defaults or load certificates from a file: 1.Public Key Certificate: a)EFI_SIGNATURE_LIST b)EFI_CERT_X509 (DER) c)EFI_CERT_RSA2048 (bin) d)EFI_CERT_SHAXXX 2.Authenticated UEFI Variable 3.EFI PE/COFF Image(SHA256) Key Source: Factory,Modified,Mixed
Factory Key Provision	[Disabled]	
▶ Restore Factory Keys ▶ Reset To Setup Mode ▶ Enroll Efi Image ▶ Export Secure Boot variables		
Secure Boot variable	Size Keys Key Source	

▶ Platform Key (PK)	Platform Key (PK)
Update	

↔: Select Screen
↑↓: Select Item
Enter: Select

4.7 Boot Settings

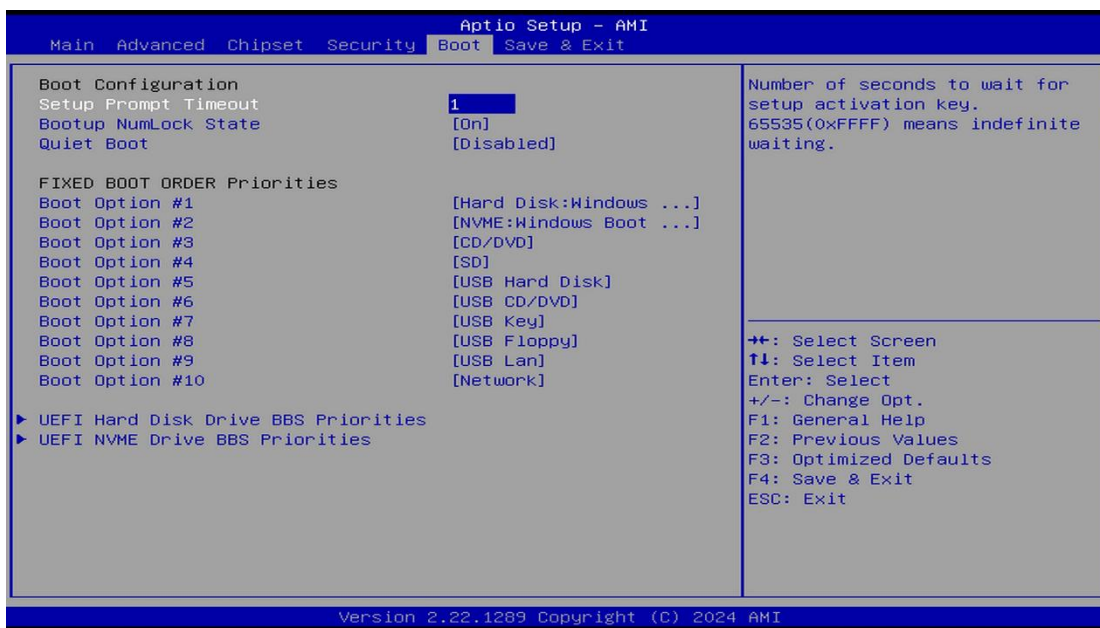

BIOS Setting	Description
Setup Prompt Timeout	Number of seconds to wait for setup activation key. 65535 (0xFFFF) means indefinite waiting.
Bootup NumLock State	Selects the keyboard NumLock state.
Quiet Boot	Enables / Disables Quiet Boot option.
Fixed Boot Option Priorities	Sets the system boot order.
Hard Disk Drive BBS Priorities	Specifies the boot device priority sequence from available Hard Disk Drives.
NVME Drive BBS Priorities	Specifies the boot device priority sequence from available NVME drives.

* UEFI (Unified Extensible Firmware Interface)

4.8 Save & Exit Settings

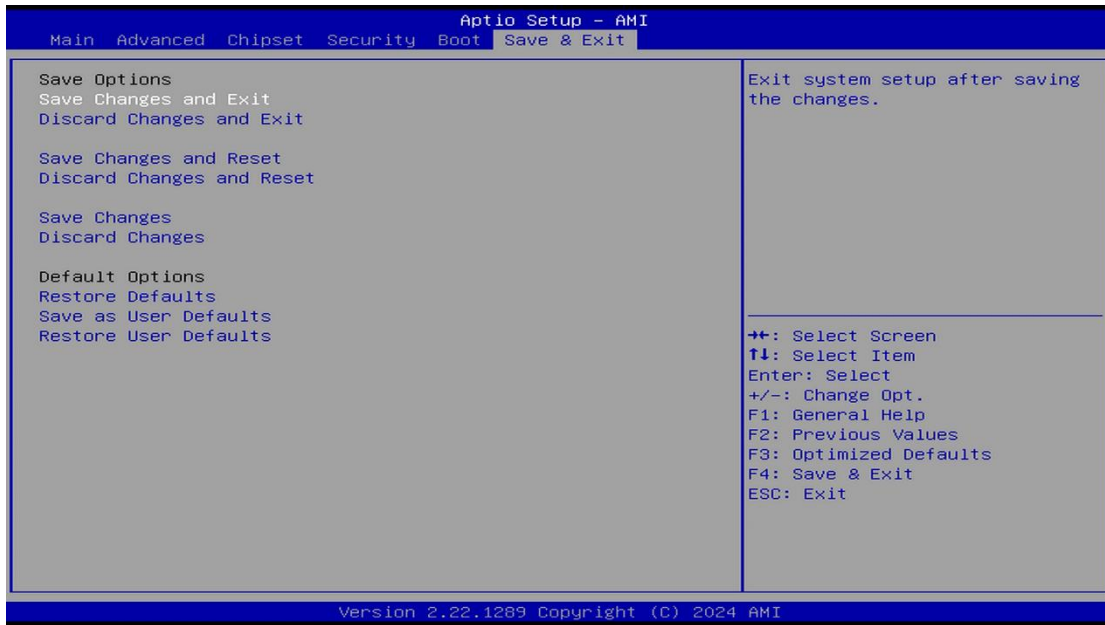

BIOS Setting	Description
Save Changes and Exit	Exits system setup after saving the changes.
Discard Changes and Exit	Exits system setup without saving any changes.
Save Changes and Reset	Resets the system after saving the changes.
Discard Changes and Reset	Resets system setup without saving any changes.
Save Changes	Saves changes done so far to any of the setup options.
Discard Changes	Discards changes done so far to any of the setup options.
Restore Defaults	Restores / Loads defaults values for all the setup options.
Save as User Defaults	Saves the changes done so far as User Defaults.
Restore User Defaults	Restores the user defaults to all the setup options.

Appendix

This section provides the mapping addresses of peripheral devices and the sample code of watchdog timer configuration.

- I/O Port Address Map
- Interrupt Request Lines (IRQ)
- Watchdog Timer Configuration
- Software Development Kit for WDT.DLL

A. I/O Port Address Map

Each peripheral device in the system is assigned a set of I/O port addresses which also becomes the identity of the device. The following table lists the I/O port addresses used.

Address	Device Description
070h – 077h	Real Time Clock
2E8h – 2EFh	Serial Port #4(COM4)
2F0h – 2F7h	<ul style="list-style-type: none">Serial Port #3(COM5) * COM5 is for internal use only.
2F8h – 2FFh	Serial Port #2(COM2)
3E8h – 3EFh	Serial Port #5(COM3)
3F8h – 3FFh	Serial Port #1(COM1)
0D00h – FFFFh	PCI-e Root Complex
5000h – 503Fh	Intel(R) UHD Graphics

B. Interrupt Request Lines (IRQ)

Peripheral devices use interrupt request lines to notify CPU for the service required. The following table shows the IRQ used by the devices on board.

Level	Function
IRQ0	System Timer
IRQ3	Serial Port #2
IRQ4	Serial Port #1
IRQ5	Serial Port #3
IRQ7	Serial Port #4
IRQ8	System CMOS/real time clock
IRQ10	Serial Port #5

C. Watchdog Timer Configuration

The Watchdog Timer (WDT) is used to generate a variety of output signals after a user programmable count. The WDT is suitable for the use in the prevention of system lock-up, such as when software becomes trapped in a deadlock. Under these sorts of circumstances, the timer will count to zero and the selected outputs will be driven.

Under normal circumstance, you will need to restart the WDT at regular intervals before the timer counts to zero.

Sample Code:

```
//-----
//
// THIS CODE AND INFORMATION IS PROVIDED "AS IS" WITHOUT WARRANTY OF ANY
// KIND, EITHER EXPRESSED OR IMPLIED, INCLUDING BUT NOT LIMITED TO THE
// IMPLIED WARRANTIES OF MERCHANTABILITY AND/OR FITNESS FOR A
// PARTICULAR PURPOSE.
//-----
#include <dos.h>
#include <conio.h>
#include <stdio.h>
#include <stdlib.h>
#include "F81966.H"
//-----
int main (int argc, char *argv[]);
void EnableWDT(int);
void DisableWDT(void);
//-----
int main (int argc, char *argv[])
{
    unsigned char bBuf;
    unsigned char bTime;
    char **endptr;

    char SIO;

    printf("Fintek 81966 watch dog program\n");
    SIO = Init_F81966();
    if (SIO == 0)
    {
        printf("Can not detect Fintek 81966, program abort.\n");
        return(1);
    }
    }

    if (argc != 2)
    {
        printf(" Parameter incorrect!!\n");
        return (1);
    }
}
```

iBASE

```
    bTime = strtol (argv[1], endptr, 10);
    printf("System will reset after %d seconds\n", bTime);

    if (bTime)
    { EnableWDT(bTime); }
    else
    { DisableWDT(); }
    return 0;
}
//-----
void EnableWDT(int interval)
{
    unsigned char bBuf;

    bBuf = Get_F81966_Reg(0x27);
    bBuf &= (~0x0C);
    bBuf |= (0x08);
    Set_F81966_Reg(0x2B, bBuf);    //Switch to bank 2

    bBuf = Get_F81966_Reg(0x2A);
    bBuf &= (~0x70);
    bBuf |= (0x60);
    Set_F81966_Reg(0x2A, bBuf);    //Enable WDTO

    Set_F81966_LD(0x07);    //Switch to logic device 7
    Set_F81966_Reg(0x30, 0x01);    //Enable timer

    bBuf = Get_F81966_Reg(0xF5);
    bBuf &= (~0x0F);
    bBuf |= 0x52;
    Set_F81966_Reg(0xF5, bBuf);    //Count mode is second

    Set_F81966_Reg(0xF6, interval); //Set timer

    bBuf = Get_F81966_Reg(0xFA);
    bBuf |= 0x01;
    Set_F81966_Reg(0xFA, bBuf);    //Enable WDTO output

    bBuf = Get_F81966_Reg(0xF5);
    bBuf |= 0x20;
    Set_F81966_Reg(0xF5, bBuf);    //Start counting
}
//-----
void DisableWDT(void)
{
    unsigned char bBuf;

    Set_F81966_LD(0x07);    //switch to logic device 7

    bBuf = Get_F81966_Reg(0xFA);
    bBuf &= ~0x01;
    Set_F81966_Reg(0xFA, bBuf); //disable WDTO output

    bBuf = Get_F81966_Reg(0xF5);
    bBuf &= ~0x20;
    bBuf |= 0x40;
    Set_F81966_Reg(0xF5, bBuf); //disable WDT
}
//-----
```

```

//-----
//
// THIS CODE AND INFORMATION IS PROVIDED "AS IS" WITHOUT WARRANTY OF ANY
// KIND, EITHER EXPRESSED OR IMPLIED, INCLUDING BUT NOT LIMITED TO THE
// IMPLIED WARRANTIES OF MERCHANTABILITY AND/OR FITNESS FOR A
// PARTICULAR PURPOSE.
//
//-----
#include "F81966.H"
#include <dos.h>
//-----
unsigned int F81966_BASE;
void Unlock_F81966 (void);
void Lock_F81966 (void);
//-----
unsigned int Init_F81966(void)
{
    unsigned int result;
    unsigned char ucDid;

    F81966_BASE = 0x4E;
    result = F81966_BASE;

    ucDid = Get_F81966_Reg(0x20);
    if (ucDid == 0x15) //Fintek 81966
    { goto Init_Finish; }

    F81966_BASE = 0x2E;
    result = F81966_BASE;

    ucDid = Get_F81966_Reg(0x20);
    if (ucDid == 0x15) //Fintek 81966
    { goto Init_Finish; }

    F81966_BASE = 0x00;
    result = F81966_BASE;

Init_Finish:
    return (result);
}
//-----
void Unlock_F81966 (void)
{
    outportb(F81966_INDEX_PORT, F81966_UNLOCK);
    outportb(F81966_INDEX_PORT, F81966_UNLOCK);
}
//-----
void Lock_F81966 (void)
{
    outportb(F81966_INDEX_PORT, F81966_LOCK);
}
//-----
void Set_F81966_LD( unsigned char LD)
{
    Unlock_F81966();
    outportb(F81966_INDEX_PORT, F81966_REG_LD);
    outportb(F81966_DATA_PORT, LD);
    Lock_F81966();
}

```

```
}
//-----
void Set_F81966_Reg( unsigned char REG, unsigned char DATA)
{
    Unlock_F81966();
    outportb(F81966_INDEX_PORT, REG);
    outportb(F81966_DATA_PORT, DATA);
    Lock_F81966();
}
//-----
unsigned char Get_F81966_Reg(unsigned char REG)
{
    unsigned char Result;
    Unlock_F81966();
    outportb(F81966_INDEX_PORT, REG);
    Result = inportb(F81966_DATA_PORT);
    Lock_F81966();
    return Result;
}
//-----

//-----
//
// THIS CODE AND INFORMATION IS PROVIDED "AS IS" WITHOUT WARRANTY OF ANY
// KIND, EITHER EXPRESSED OR IMPLIED, INCLUDING BUT NOT LIMITED TO THE
// IMPLIED WARRANTIES OF MERCHANTABILITY AND/OR FITNESS FOR A
// PARTICULAR
// PURPOSE.
//
//-----
#ifndef F81966_H
#define F81966_H 1
//-----
#define F81966_INDEX_PORT (F81966_BASE)
#define F81966_DATA_PORT (F81966_BASE+1)
//-----
#define F81966_REG_LD 0x07
//-----
#define F81966_UNLOCK 0x87
#define F81966_LOCK 0xAA
//-----
unsigned int Init_F81966(void);
void Set_F81966_LD( unsigned char);
void Set_F81966_Reg( unsigned char,
unsigned char); unsigned char
Get_F81966_Reg( unsigned char);
//-----
#endif // F81966_H
```