

# **SI-624-AI**

## **Extreme Performance Digital Signage Player**

### **User's Manual**

Version 1.0  
(December 2023)



## **Copyright**

© 2023 IBASE Technology, Inc. All rights reserved.

No part of this publication may be reproduced, copied, stored in a retrieval system, translated into any language or transmitted in any form or by any means, electronic, mechanical, photocopying, or otherwise, without the prior written consent of IBASE Technology, Inc. (hereinafter referred to as "IBASE").

## **Disclaimer**

IBASE reserves the right to make changes and improvements to the products described in this document without prior notice. Every effort has been made to ensure the information in the document is correct; however, IBASE does not guarantee this document is error-free. IBASE assumes no liability for incidental or consequential damages arising from misapplication or inability to use the product or the information contained herein, nor for any infringements of rights of third parties, which may result from its use.

## **Trademarks**

All the trademarks, registrations and brands mentioned herein are used for identification purposes only and may be trademarks and/or registered trademarks of their respective owners.

# Compliance

## CE

In a domestic environment, this product may cause radio interference in which case users may be required to take adequate measures.

## FCC

This product has been tested and found to comply with the limits for a Class B device, pursuant to Part 15 of the FCC Rules. These limits are designed to provide reasonable protection against harmful interference in a residential installation. This equipment generates, uses and can radiate radio frequency energy and, if not installed and used in accordance with manufacturer's instructions, may cause harmful interference to radio communications.

## WEEE



This product must not be disposed of as normal household waste, in accordance with the EU directive of for waste electrical and electronic equipment (WEEE - 2012/19/EU). Instead, it should be disposed of by returning it to a municipal recycling collection point. Check local regulations for disposal of electronic products.

## Green IBASE



This product is compliant with the current RoHS restrictions and prohibits use of the following substances in concentrations exceeding 0.1% by weight (1000 ppm) except for cadmium, limited to 0.01% by weight (100 ppm).

- Lead (Pb)
- Mercury (Hg)
- Cadmium (Cd)
- Hexavalent chromium (Cr6+)
- Polybrominated biphenyls (PBB)
- Polybrominated diphenyl ether (PBDE)

## Important Safety Information

Carefully read the precautions before using the device.

### Environmental conditions:

- Lay the device horizontally on a stable and solid surface in case the device may fall, causing serious damage.
- Leave plenty of space around the device and do not block the openings for ventilation. **NEVER DROP OR INSERT ANY OBJECTS OF ANY KIND INTO THE VENTILATION OPENINGS.**
- Use this product in environments with ambient temperatures between 0°C and 45°C.
- **DO NOT LEAVE THIS DEVICE IN AN ENVIRONMENT WHERE THE STORAGE TEMPERATURE MAY IS BELOW -20° C OR ABOVE 80° C.** This could damage the device. The device must be used in a controlled environment.

### Care for your iBASE products:

- Before cleaning the device, turn it off and unplug all cables such as power in case a small amount of electrical current may still flow.
- Use neutral cleaning agents or diluted alcohol to clean the device chassis with a cloth. Then wipe the chassis with a dry cloth.
- Vacuum the dust with a computer vacuum cleaner to prevent the air vent or slots from being clogged.



## WARNING

### Attention during use:

- Do not use this product near water.
- Do not spill water or any other liquids on your device.
- Do not place heavy objects on the top of the device.
- Operate this device from the type of power indicated on the marking label. If you are not sure of the type of power available, consult your distributor or local power company.
- Do not walk on the power cord or allow anything to rest on it.
- If you use an extension cord, make sure that the total ampere rating of the product plugged into the extension cord does not exceed its limits.

### Avoid Disassembly

Do not disassemble, repair or make any modification to the device. Doing so could generate hazards and cause damage to the device, even bodily injury or property damage, and will void any warranty.



## CAUTION

There is danger of explosion if internal lithium-ion battery is replaced by an incorrect type. Replace only with the same or equivalent type recommended by the manufacturer. Dispose of used batteries according to the manufacturer's instructions.

## Warranty Policy

- **IBASE standard products:**

24-month (2-year) warranty from the date of shipment. If the date of shipment cannot be ascertained, the product serial numbers can be used to determine the approximate shipping date.

- **3<sup>rd</sup>-party parts:**

12-month (1-year) warranty from delivery for the 3<sup>rd</sup>-party parts that are not manufactured by IBASE, such as CPU, CPU cooler, memory, storage devices, power adapter, panel and touchscreen.

\* PRODUCTS, HOWEVER, THAT FAIL DUE TO MISUSE, ACCIDENT, IMPROPER INSTALLATION OR UNAUTHORIZED REPAIR SHALL BE TREATED AS OUT OF WARRANTY AND CUSTOMERS SHALL BE BILLED FOR REPAIR AND SHIPPING CHARGES.

## Technical Support & Services

1. Visit the IBASE website at [www.ibase.com.tw](http://www.ibase.com.tw) to find the latest information about the product.
2. If you need any further assistance from your distributor or sales representative, prepare the following information of your product and elaborate upon the problem.
  - Product model name
  - Product serial number
  - Detailed description of the problem
  - The error messages in text or in screenshots if there is any
  - The arrangement of the peripherals
  - Software in use (such as OS and application software, including the version numbers)
3. If repair service is required, you can download the RMA form at <http://www.ibase.com.tw/english/Supports/RMAService/>. Fill out the form and contact your distributor or sales representative.

# Table of Contents

---

<b>Chapter 1</b>	<b>General Information .....</b>	<b>1</b>
1.1	Introduction .....	2
1.2	Features.....	2
1.3	Packing List .....	3
1.4	Specifications.....	3
1.5	Product View.....	5
1.6	Dimensions .....	7
<b>Chapter 2</b>	<b>Hardware Installation &amp; Motherboard Information .....</b>	<b>8</b>
2.1	Installation / Replacement.....	9
2.1.1	Memory .....	10
2.1.2	M.2 Cards.....	10
2.1.3	WiFi / 3G / 4G Antenna Installation.....	12
2.1.4	Mounting Installation.....	13
2.2	Setting the Jumpers .....	14
2.3	Jumper & Connector Locations on Motherboard .....	15
2.4	Jumper Locations.....	16
2.4.1	JP1: Clear CMOS Data.....	16
2.4.2	JP2: Clear RTC .....	16
2.4.3	JP3: AT/ATX Select.....	17
2.4.4	JP5: Flash Descriptor Security Override .....	17
2.4.5	JP6: Sierra EM9191 5G Card USB/PCIe Select .....	18
2.5	Connectors Locations .....	19
2.5.1	Front Side Connectors.....	19
2.5.2	Rear Side Connectors .....	19
2.5.3	CN8: DC In Connector.....	20
2.5.4	CN10, CN11: SATA Connectors.....	20
2.5.5	J1: External Power Switch .....	21
2.5.6	J2: Front Panel Audio Connector.....	21
2.5.7	J4: OOB.....	22
2.5.8	J5: Digital I/O Connector (4 in, 4 out).....	23
2.5.9	J7: M.2 2280 M-Key Socket (supports NVME).....	23
2.5.10	J8: Reset Button Connector.....	24
2.5.11	J9, J11: COM3, COM4 RS232 Serial Ports .....	24
2.5.12	J13: USB 2.0 Connector .....	25
2.5.13	J14: USB 3.1 Connector .....	26
2.5.14	J15: M.2 2230 E-key Socket.....	27

2.5.15	J17: M.2 3053 B-Key Socket .....	27
2.5.16	J18: Mini SIM Socket.....	28
2.5.17	J22: M.2 2280 M-Key Socket.....	28
2.5.18	J23, J24: SATA HDD Power Connectors.....	29
2.5.19	PWM Fan Power Connector (CPU_FAN1, SYS_FAN1, SYS_FAN2) .....	29
2.5.20	CN9: MXM Connector.....	30
<b>Chapter 3 Driver Installation .....</b>		<b>32</b>
3.1	Introduction .....	33
3.2	Intel® Chipset Software Installation Utility.....	33
3.3	HD Audio Driver Installation .....	34
3.4	LAN Driver Installation .....	34
3.5	Intel® Management Engine Components Drivers Installation.....	35
3.6	NVIDIA® GeForce® MXM Driver Installation .....	35
<b>Chapter 4 BIOS Setup.....</b>		<b>36</b>
4.1	Introduction .....	37
4.2	BIOS Setup.....	37
4.3	Main Settings .....	38
4.4	Advanced Settings .....	39
4.5	Chipset Settings.....	51
4.6	Security Settings .....	53
4.7	Boot Settings.....	54
4.8	Save & Exit Settings.....	55
<b>Appendix .....</b>		<b>56</b>
A.	I/O Port Address Map.....	57
B.	Interrupt Request Lines (IRQ) .....	59
C.	Watchdog Timer Configuration.....	60





# Chapter 1

## General Information

The information provided in this chapter includes:

- Features
- Packing List
- Accessories
- Specifications
- Product View
- Dimensions

## 1.1 Introduction

The SI-624-AI is a power-packed industrial AI computer with NVIDIA Ampere MXM GPU that is designed to meet the demands of high-speed multiple tasks for artificial neural network applications. Powered by the 12th/13th Gen Intel® Core™ CPU, this cutting-edge system delivers image processing capabilities that enable real-time analysis of visual data, enhancing automation, quality control, and overall production efficiency for AIoT applications in smart factory, retail, transportation or medical fields. It is suitable for use as a digital signage control system in mission-critical control rooms in transportation networks, smart retail, healthcare, or medical fields where remote AI data analysis capabilities are required.

The compact SI-624-AI features four DP++ outputs for simultaneous high-resolution displays in multi-monitor configurations and reliably delivers high-quality live video or AI analytics content with 4x 4K or 2x 8k display outputs, enabling institutions to connect and communicate with their audiences. It is equipped with iSMART intelligent energy-saving and Observer remote monitoring technologies to reduce energy consumption and minimize downtime.



## 1.2 Features

- iSMART intelligent energy-saving & Observer remote monitoring technologies
- 12th/13th Gen Intel® Desktop Core™ i7/i5/i3 / Pentium® / Celeron® QC/DC processors
- 4x DDR4-3200 UDIMM, Max.128GB
- NVIDIA Ampere Architecture MXM GPU cards (Type A/B, up to 115W)
- 4x DP++ output
- 1x M.2 B-Key (3052) for 5G or LTE options
- 1x M.2 E-Key (2230) & 2x M.2 M-Key (2280) for Wi-Fi, Bluetooth, capture or storage options
- Supports OOB function via I210 LAN port (optional)
- Supports TPM 2.0

### 1.3 Packing List

Your product package should include the items listed below. If any of the items below is missing, contact the distributor or the dealer from whom you purchased the product.

- SI-624-AI
- Power Adaptor
- Power Cord
- Cable Bracket

### 1.4 Specifications

<b>Model Name</b>	<b>SI-624-AI</b>
<b>Mainboard</b>	MBD624
<b>Operating System</b>	Windows 10 & Linux
<b>CPU</b>	12th/13th Gen Intel® RPL-PS Core™ processors
<b>CPU Socket</b>	LGA1700
<b>Chipset</b>	Q670E/R680E PCH
<b>Memory</b>	4x DDR4-3200 SO DIMM, Max. 128GB
<b>Graphics</b>	12th/13th Gen Intel® Core™ i9/i7/i5/i3 processors integrated
<b>LAN</b>	2x Gigabit LAN
<b>Expansion Slots</b>	<ul style="list-style-type: none"> <li>• 1x M.2 E-Key (2230)</li> <li>• 1x M.2 B-Key (3052)</li> <li>• 1x M.2 (M-Key, type:2280, supports NVMe with PCI-E(x4) Gen.4 signal only)</li> <li>• 1x M.2 (M-Key, type:2280 , supports PCIe Gen.3 &amp; SATA)</li> <li>• 1x UIM/SIM card slot</li> <li>• 1x MXM 3.1 Type-B</li> </ul>
<b>I/O Interface</b>	<ul style="list-style-type: none"> <li>• 1x HDMI 1.4 for console</li> <li>• 4x DisplayPort</li> <li>• 4x USB 3.0</li> <li>• 2x RJ45 for Gigabit LAN</li> <li>• COM1 &amp; COM2: RS-232/422/485 (jumper-less selection)</li> <li>• 1x Audio connector for Line-in/out/MIC</li> <li>• 1x Power / HDD LED</li> <li>• 1x Power button</li> <li>• 1x Power jack connector</li> </ul>

<b>Storage</b>	2x M.2 NVMe SSD drive bay
<b>Auto Control and Monitoring</b>	Watchdog Timer: 256 segments, 0, 1, 2...255 (sec/min)
<b>Power Requirement</b>	+19V DC
<b>Construction</b>	SGCC
<b>Weight</b>	3.8kg (8.38lbs)
<b>Chassis Color</b>	Black and white
<b>Power Supply</b>	270W power adaptor
<b>Mounting</b>	Standard system bracket
<b>Dimensions</b>	329.2mm(W) x 210mm(D) x73.1mm(H) 129.6"(W) x 82.6"(D) x 28.7"(H)
<b>Environment</b>	
<b>Temperature</b>	<ul style="list-style-type: none"> <li>• <b>Operating:</b> 0°C~ 45°C (32°F~113°F)</li> <li>• <b>Storage:</b> -20°C ~ 80°C (-4°F~176°F)</li> </ul>
<b>Relative Humidity</b>	5 ~ 90% at 45 °C (non-condensing)
<b>Vibration Protection</b>	SSD: random operation 5 grms, 5~500 Hz
<b>Others</b>	
<b>Certification</b>	CE, FCC class-B, UL & CCC
<b>Operating System</b>	Windows 10 / Linux

All specifications are subject to change without prior notice.

## 1.5 Product View

### Front View



### Rear View





## 1.6 Dimensions

Unit: mm

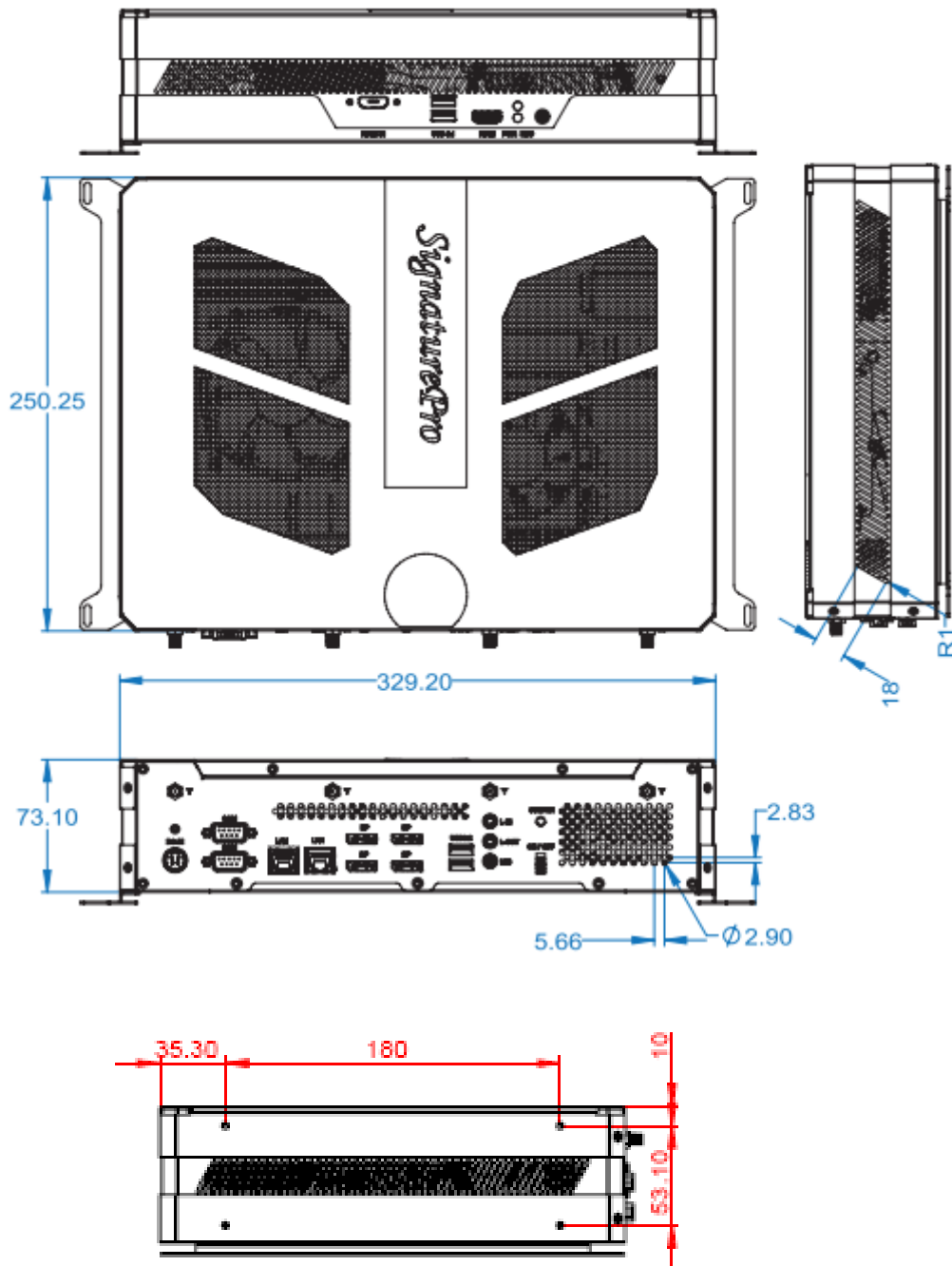

## Chapter 2

# Hardware Installation & Motherboard Information

The information provided in this chapter includes:

- Installation of memory and M.2 cards
- Information and locations of connectors



## 2.1 Installation / Replacement

To access the parts on the motherboard for the purpose of removal, installation or replacement of components such as memory modules or M.2 cards, remove the two screws and slide the device cover backwards to remove it.

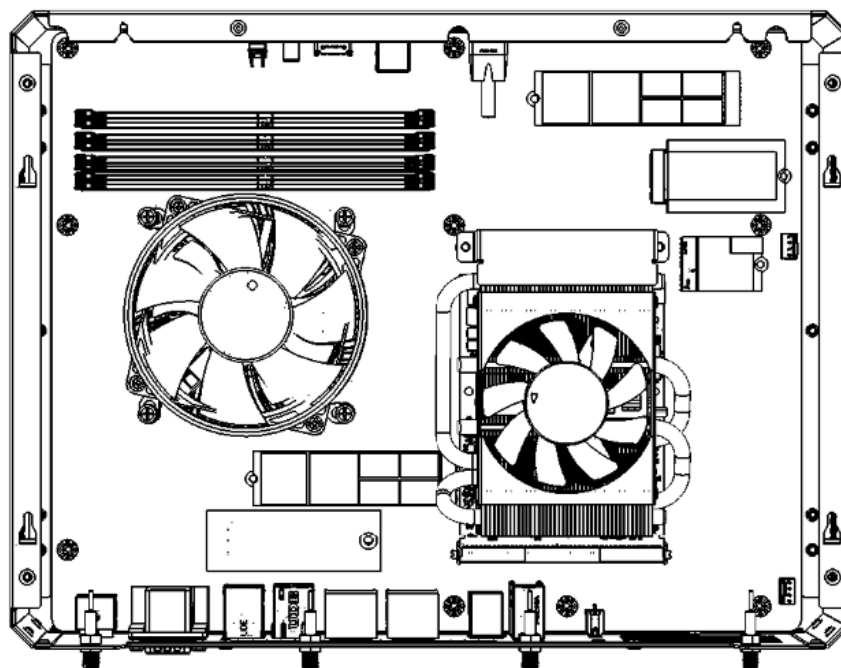
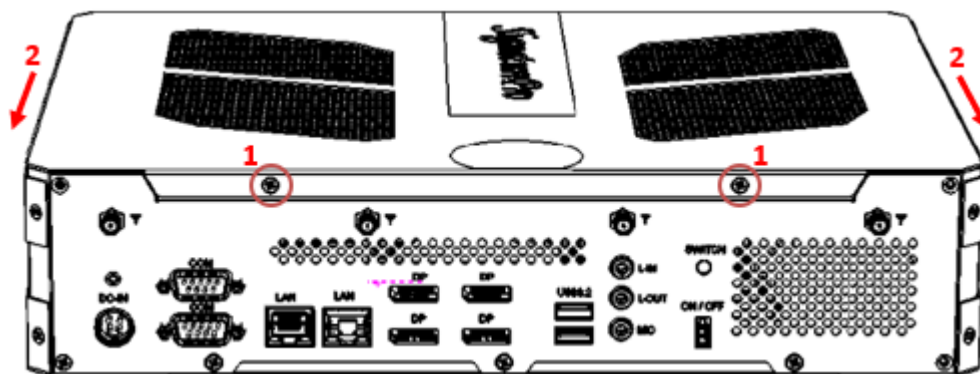

## 2.1.1 Memory

To install the modules, locate the memory slot on the motherboard and perform the following steps:

1. Press the ejector tab of the memory slot down and outwards with your fingertips.

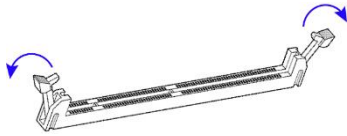

2. Hold the memory module and align the key of the module with that on the memory slot.
3. Gently push the module down in an upright position until it touches the bottom of the slot, at which point the ejector tabs will close to hold the module in place..

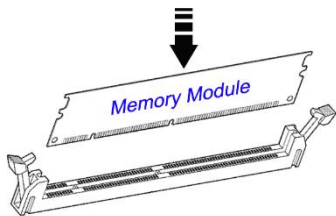

To remove the module, press the ejector tabs outwards with your fingertips to eject the module.

## 2.1.2 M.2 Cards

To remove and install the mini PCIe or M.2 card, remove the device cover as mentioned in the previous section and locate that card socket for removal or installation.

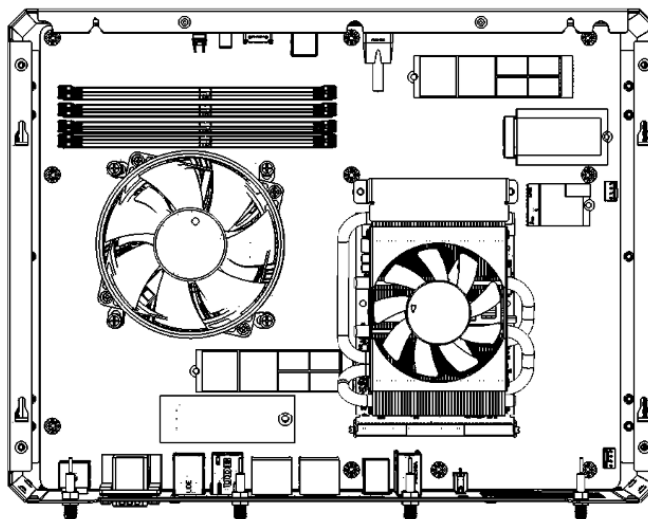

1. Locate the M.2 slot inside the device.
2. Align the key of the M.2 card to the interface, and insert the card slantwise.
3. Push the M.2 card down and fix it with an M3 screw.

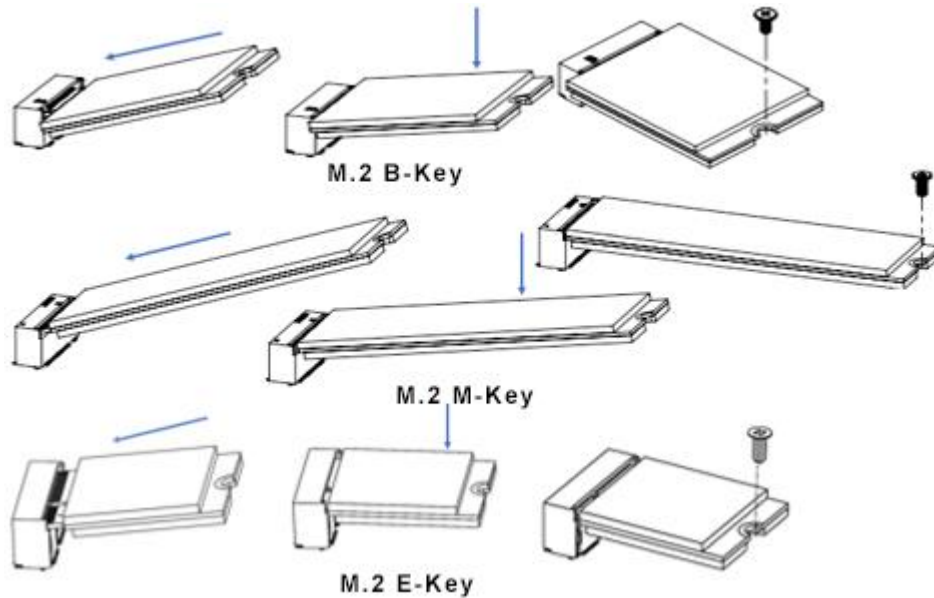

Remarks: The M.2 card connectors in the system are:

- J7: M.2 2280 M-Key Socket
- J15: M.2 2230 E-key Socket
- J17: M.2 3053 B-Key Socket
- J22: M.2 2280 M-Key Socket

## 2.1.3 WiFi / 3G / 4G Antenna Installation

Thread the WiFi/3G/4G antenna extension cable through an antenna hole of the front I/O cover and fasten the antenna as shown below. Then apply adhesive to the edge of the hex nut behind the front I/O cover to prevent the extension cable from falling if the cable becomes loose.

1. Thread the washer and then fasten the hex nut.

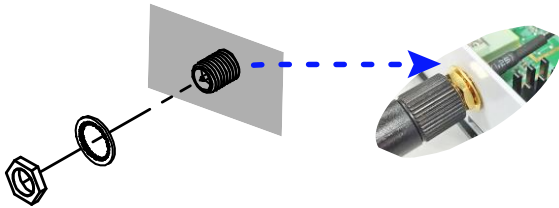

2. Apply adhesive to the specified area on the hex nut

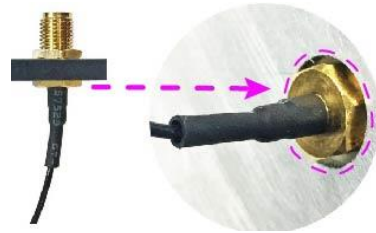

---

**Info:** The diameter of the nut is around 6.35 mm (0.25"-36UNC).

---

## 2.1.4 Mounting Installation

### Requirements

Before mounting the system, ensure that you have enough room for the power adaptor and signal cable routing, and have good ventilation for the power adaptor.

### Wall Mounting Installation

1. Turn your device upside down. Attach the wall-mount kit (2 brackets) to the device and secure with the supplied screws.

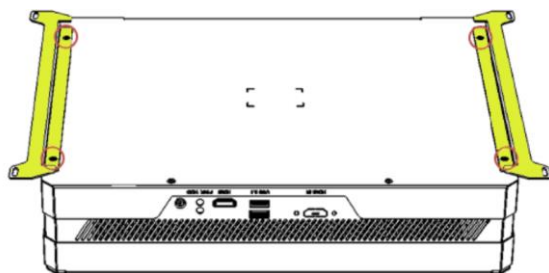

2. Prepare 4 screws (M3) to install the device on the wall.

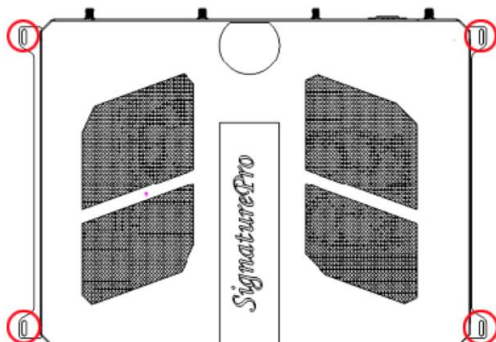

You can also install the wall mount kit onto the side of the device as shown.



## 2.2 Setting the Jumpers

Set up and configure your SI-613 by using jumpers for various settings and features according to your needs and applications. Contact your supplier if you have doubts about the best configuration for your use.

Jumpers are short-length conductors consisting of several metal pins with a non-conductive base mounted on the circuit board. Jumper caps are used to have the functions and features enabled or disabled. If a jumper has 3 pins, you can connect either PIN1 to PIN2 or PIN2 to PIN3 by shorting.

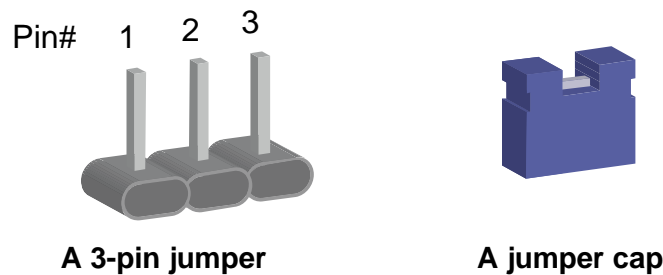

Refer to the illustration below to set jumpers.

Pin closed	Oblique view	Illustration
Open		
1-2		
2-3		

When two pins of a jumper are encased in a jumper cap, this jumper is **closed**, i.e. turned **On**.

When a jumper cap is removed from two jumper pins, this jumper is **open**, i.e. turned **Off**.

## 2.3 Jumper & Connector Locations on Motherboard

Motherboard: MBD624

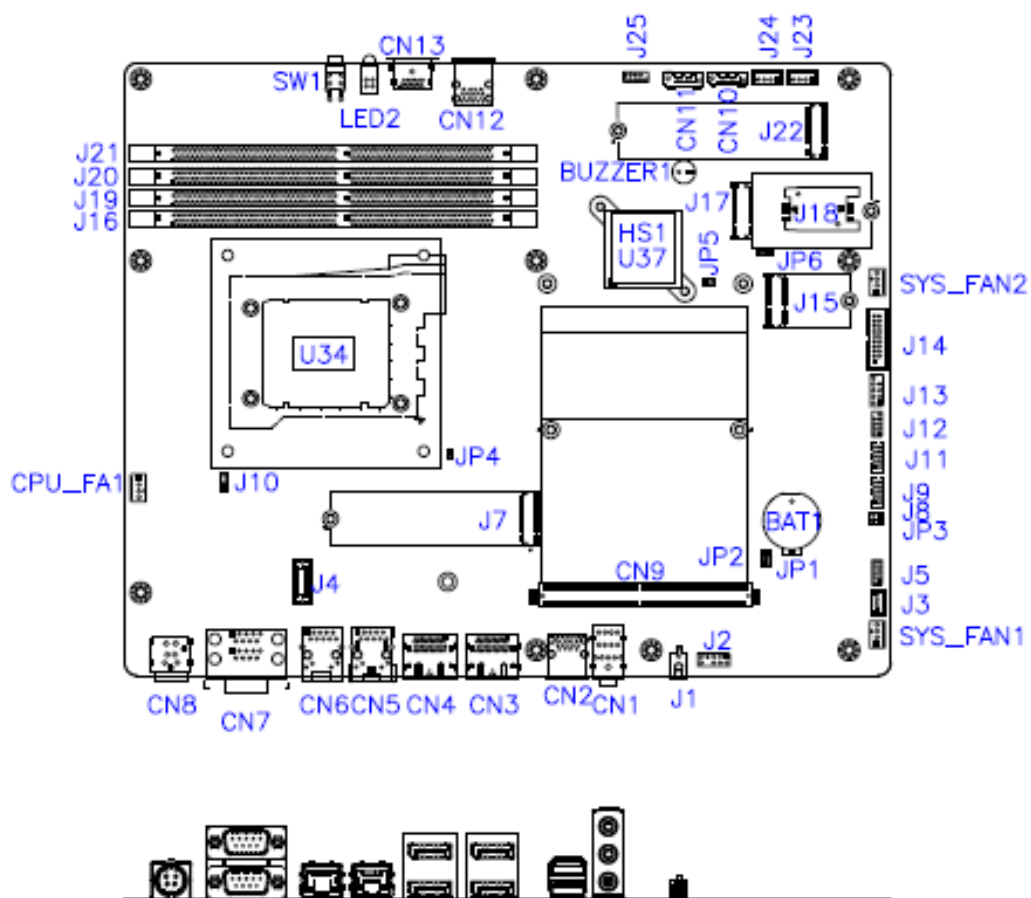

MBD624 – top and I/O

## 2.4 Jumper Locations

### 2.4.1 JP1: Clear CMOS Data

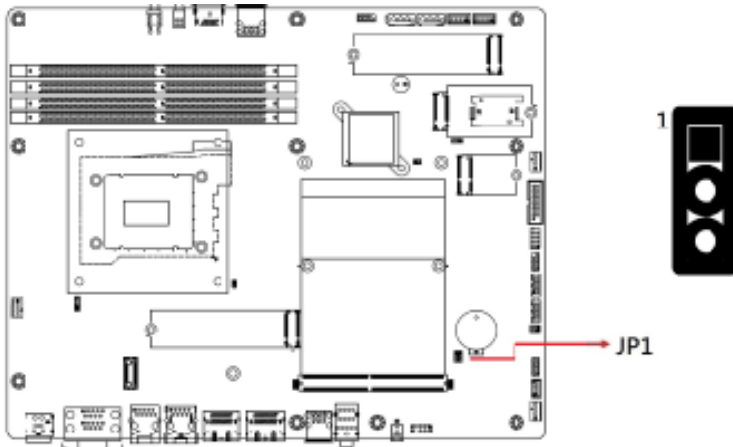

Function	Pin closed	Illustration
Normal (default)	1-2	1
Clear CMOS	2-3	1

### 2.4.2 JP2: Clear RTC

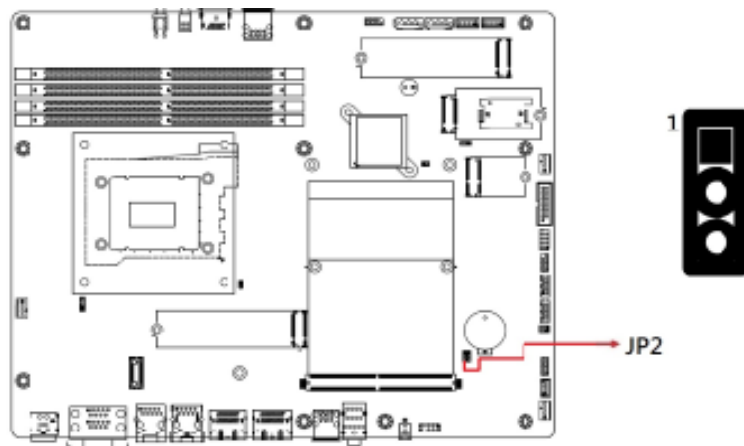



Function	Pin closed	Illustration
Normal (default)	1-2	1
Clear CMOS	2-3	1



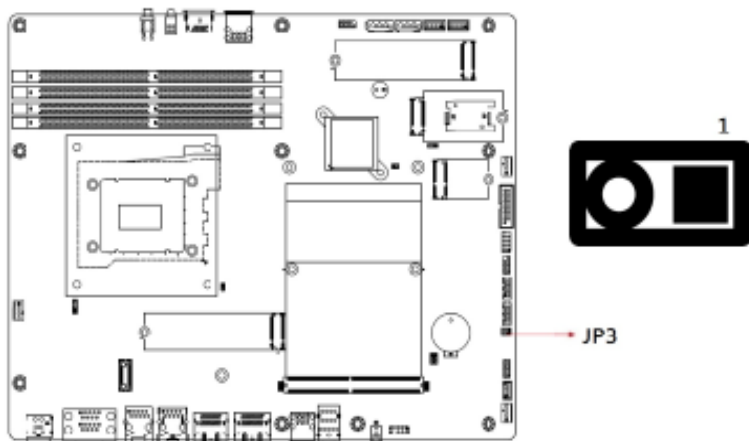

### 2.4.3 JP3: AT/ATX Select

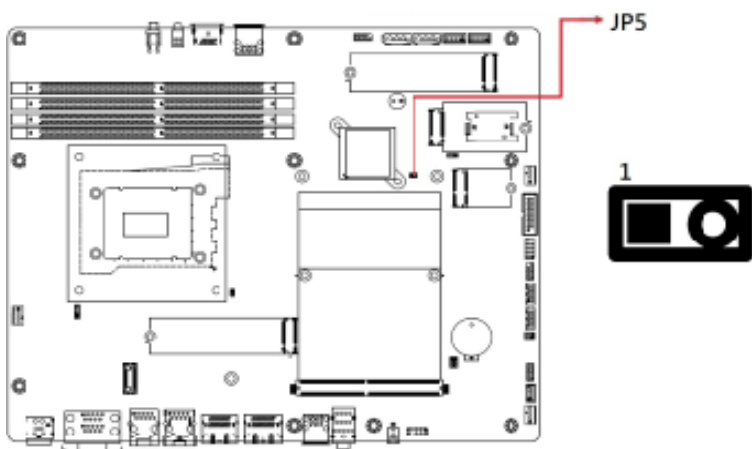

Function	Pin closed	Illustration
ATX (default)	Open	 1
AT	Close	 1

### 2.4.4 JP5: Flash Descriptor Security Override



Function	Pin closed	Illustration
Disabled (default)	Open	 1
Enabled	Close	 1

**2.4.5 JP6: Sierra EM9191 5G Card USB/PCIe Select**

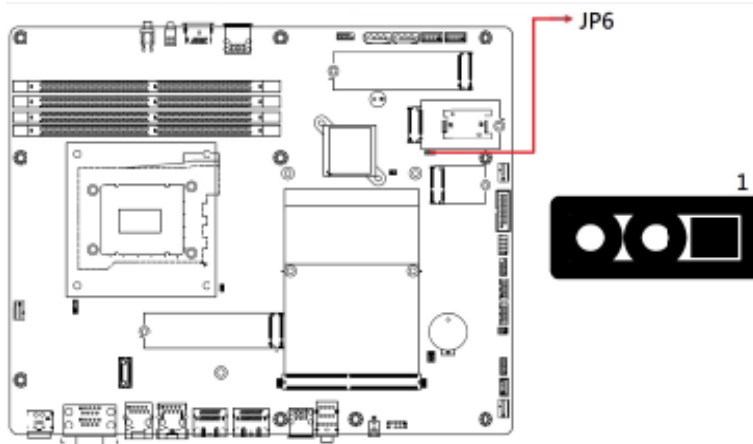

Function	Pin closed	Illustration
USB	1-2	1
PCIe (default)	2-3	1

## 2.5 Connectors Locations

### 2.5.1 Front Side Connectors

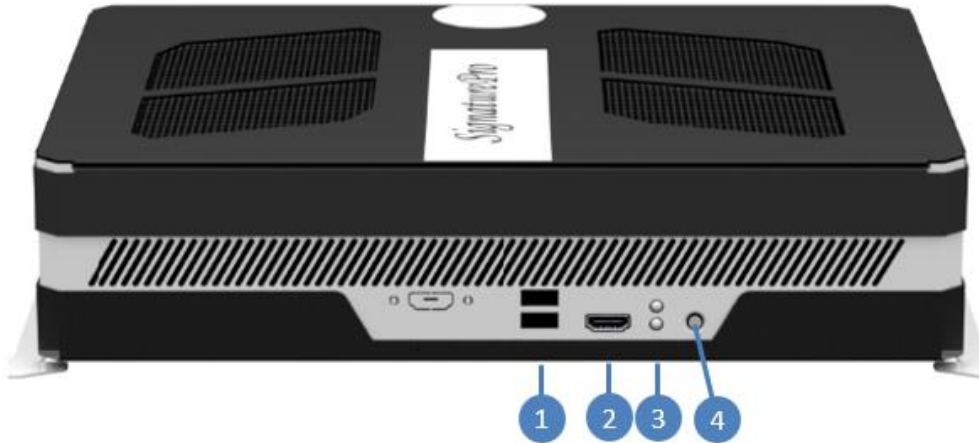

No.	Name	No.	Name
1	USB 3.1 Ports (CN12)	3	LED Indicators
2	HDMI Port for Intel (CN13)	4	Power Button (SW1)

### 2.5.2 Rear Side Connectors

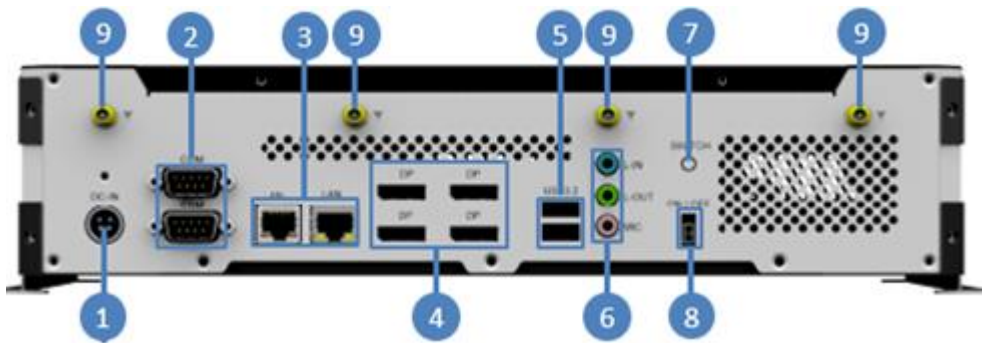

No.	Name	No.	Name
1	DC Power Input (CN8)	6	Audio Jacks (CN1)
2	COM Ports (CN7)	7	Power Button
3	LAN Ports (CN6, CN5)	8	External Power Switch (J1)
4	DP Ports for MXM (CN4, CN3)	9	Antenna Holes
5	USB Ports (CN2)		

**2.5.3 CN8: DC In Connector**

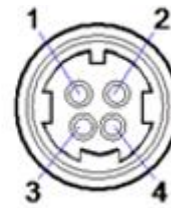

Pin	Signal Name	Pin	Signal Name
1	+19V	2	+19V
3	Ground	4	Ground

**2.5.4 CN10, CN11: SATA Connectors**

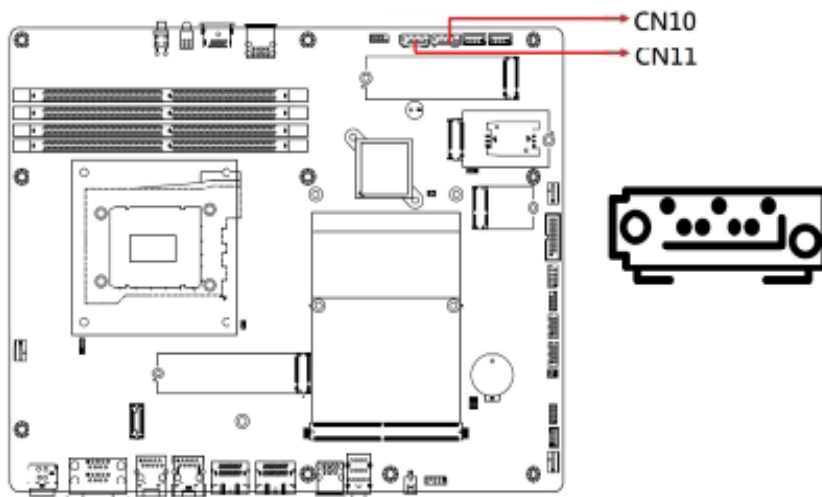

Pin	Signal Name	Pin	Signal Name
1	Ground	5	RX-
2	TX+	6	RX+
3	TX-	7	Ground
4	Ground		

### 2.5.5 J1: External Power Switch

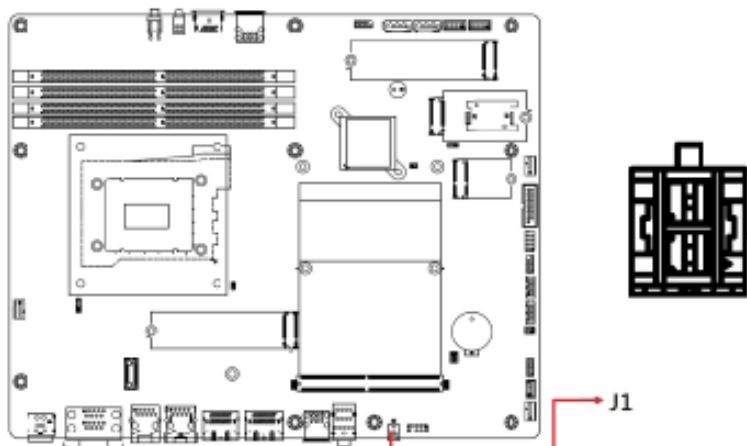

Pin	Signal Name
1	Power BTN-
2	Power BTN+

### 2.5.6 J2: Front Panel Audio Connector

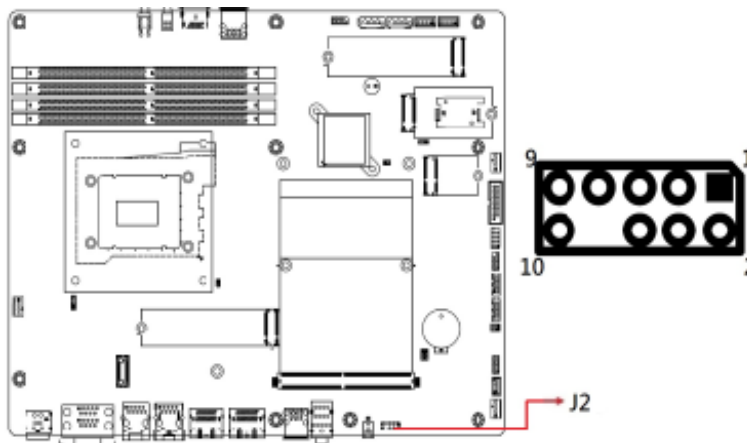

Pin	Signal Name	Pin	Signal Name
1	MIC IN_L	2	Ground
3	MIC IN_R	4	DET
5	LINE_R	6	Ground
7	Sense	8	Key
9	LINE_L	10	Ground

**2.5.7 J4: OOB**

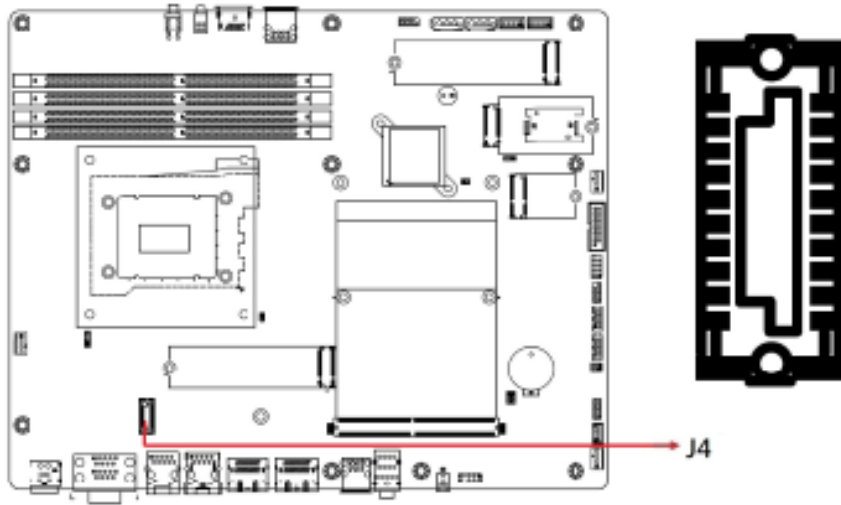

Pin	Signal Name	Pin	Signal Name
A1	3.3V	B1	3.3V
A2	GND	B2	GND
A3	NC_SI_TXD0	B3	PM_SYSRST#
A4	NC_SI_TXD1	B4	PWR_BTN#
A5	NC_SI_TX_EN	B5	Edge Device Power detetion
A6	NC_SI_CLK_IN	B6	Uart_TXD
A7	NC_SI_RXD0	B7	Uart_RXD
A8	NC_SI_RXD1 -	B8	NC
A9	NC_SI_CRS_DV	B9	NC
A10	GND	B10	GND

Connector type: EPT\_403-53020-51

### 2.5.8 J5: Digital I/O Connector (4 in, 4 out)

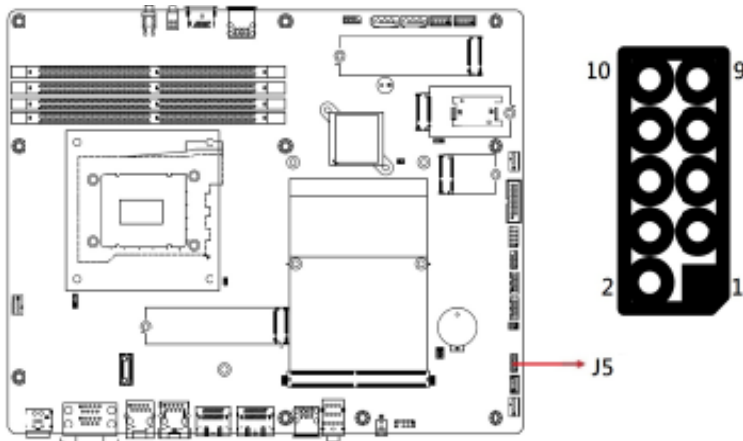

Pin	Signal Name	Pin	Signal Name
1	Ground	2	+5V
3	Out3	4	Out1
5	Out2	6	Out0
7	IN3	8	IN1
9	IN2	10	IN0

### 2.5.9 J7: M.2 2280 M-Key Socket (supports NVME)

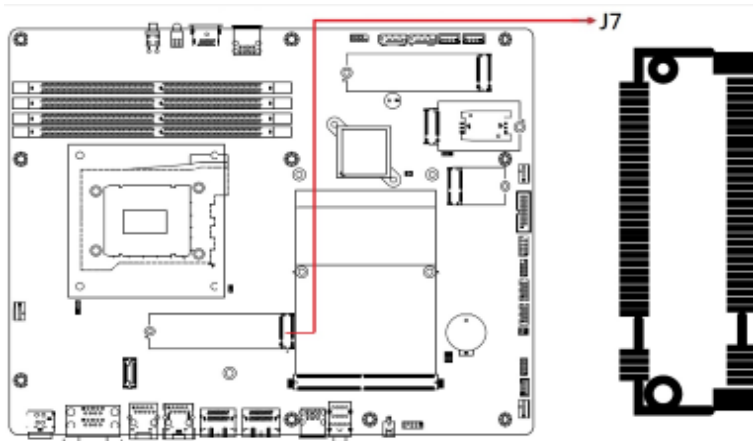

**2.5.10 J8: Reset Button Connector**

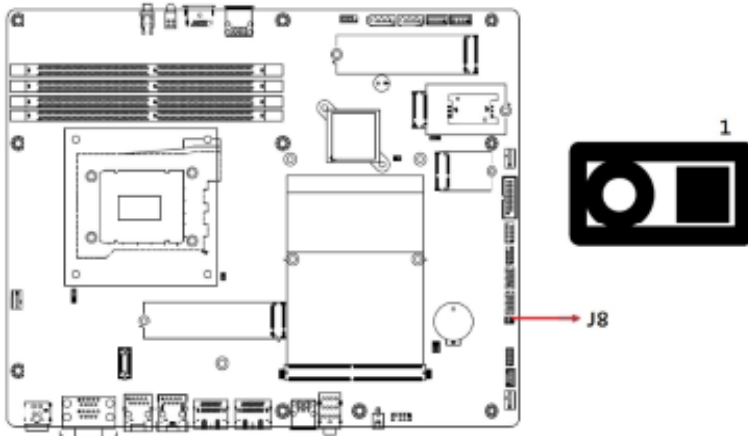

**2.5.11 J9, J11: COM3, COM4 RS232 Serial Ports**

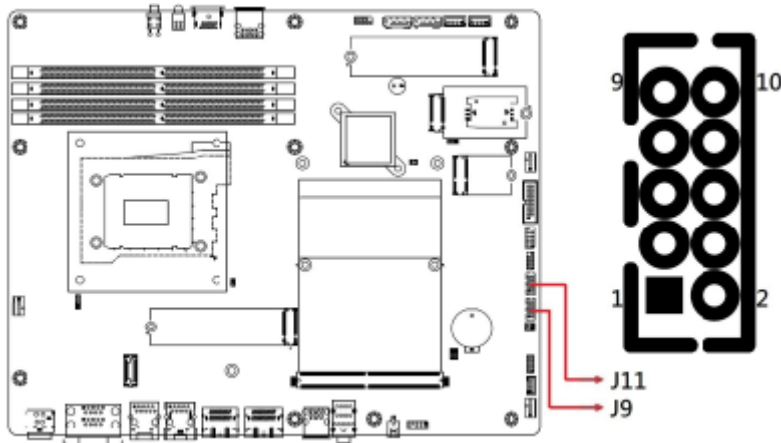

Pin	Signal Name	Pin	Signal Name
1	DCD#	2	SIN#
3	SOUT	4	DTR#
5	GND	6	DSR#
7	RTS#	8	CTS#
9	RI#	10	Key

Connector type: HK\_DF11-10S-PA66H



### 2.5.12 J13: USB 2.0 Connector

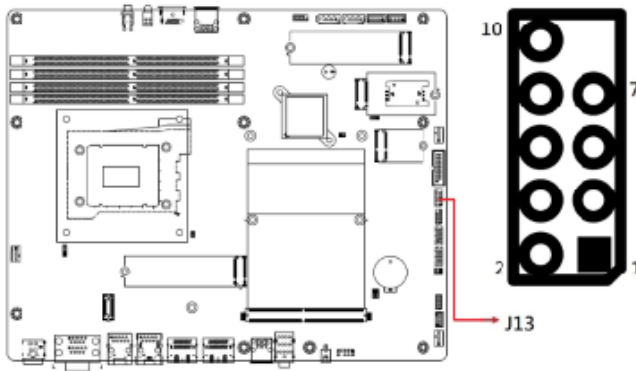

Pin	Signal Name	Pin	Signal Name
1	Vcc	2	VCC
3	D0-	4	D1-
5	D0+	6	D1+
7	Ground	8	Ground
9	Key	10	NC

**2.5.13 J14: USB 3.1 Connector**

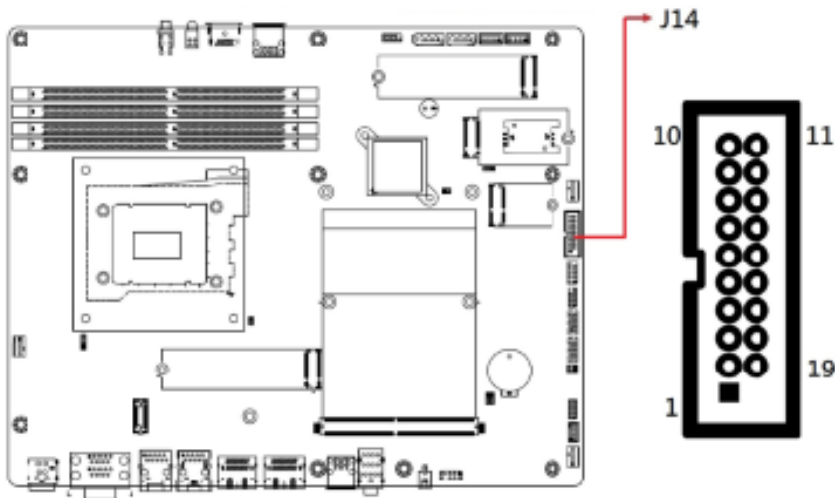

Pin	Signal Name	Pin	Signal Name
1	VCC	X	
2	P1_SSRX-	19	VCC
3	P1_SSRX+	18	P2_SSRX-
4	GND	17	P2_SSRX+
5	P1_SSTX-	16	GND
6	P1_SSTX+	15	P2_SSTX-
7	GND	14	P2_SSTX+
8	P1_U2_D-	13	GND
9	P1_U2_D+	12	P2_U2_D
10	NC	11	P2_U2_D+

Connector type: PINREX\_52X-40-20GU52

### 2.5.14 J15: M.2 2230 E-key Socket

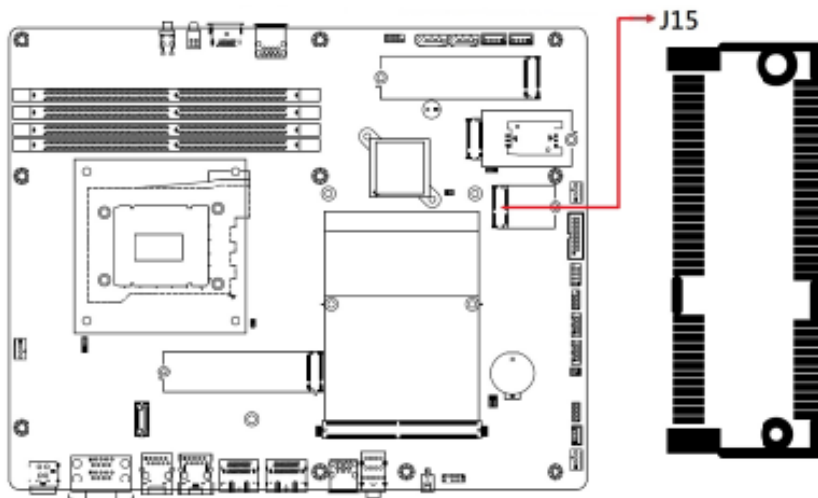

Supports, PCIe×1, USB 2.0, CNVi

### 2.5.15 J17: M.2 3053 B-Key Socket

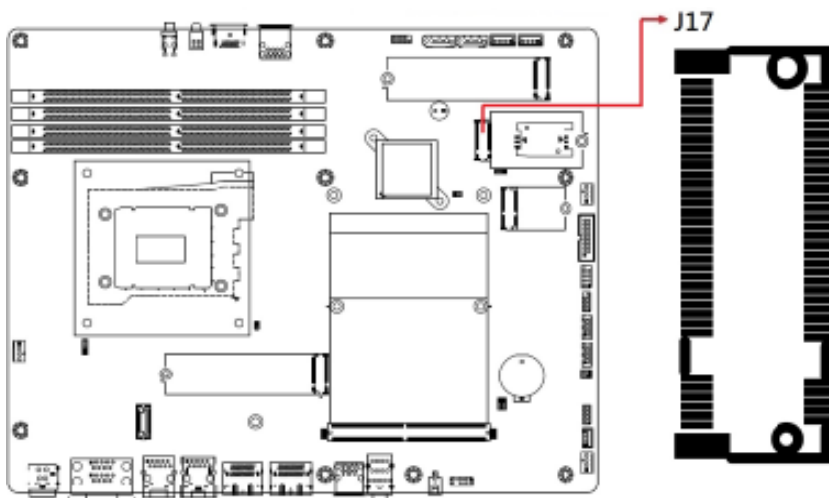

Supports 5G/4G/LTE, Sierra LTE module

**2.5.16 J18: Mini SIM Socket**

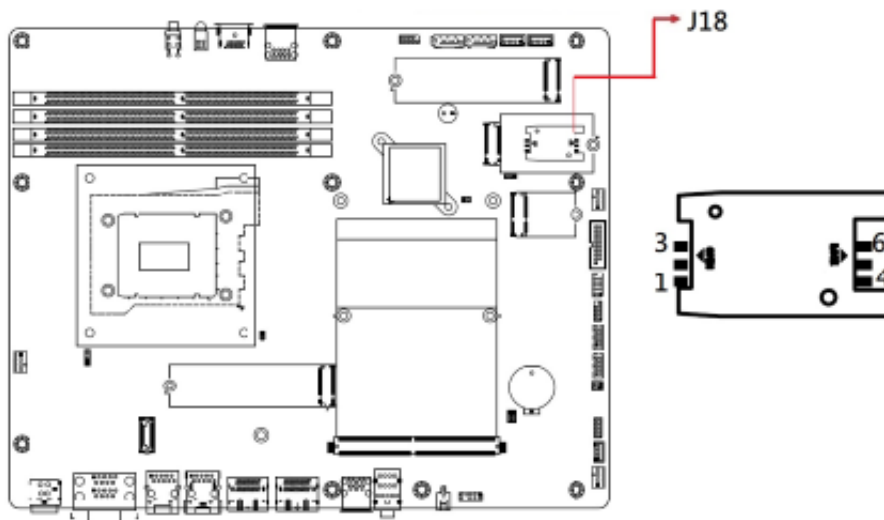

Supports 5G/4G/LTE, Sierra LTE module

**2.5.17 J22: M.2 2280 M-Key Socket**

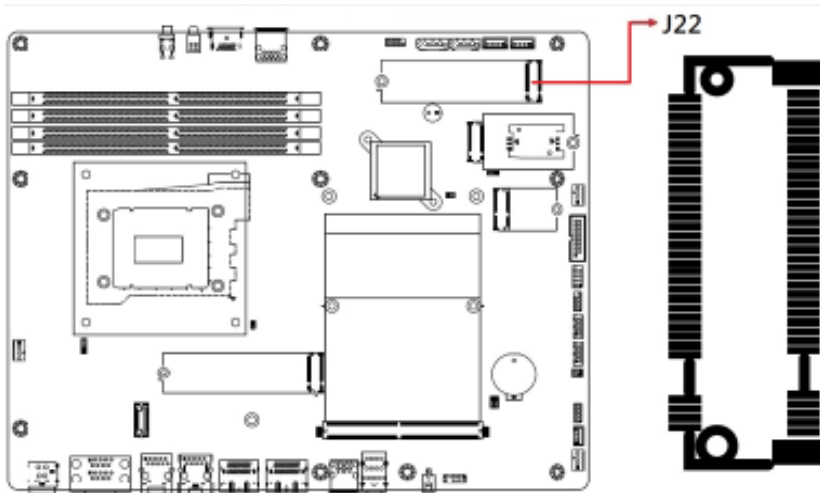

Supports PCIe & SATA

### 2.5.18 J23, J24: SATA HDD Power Connectors

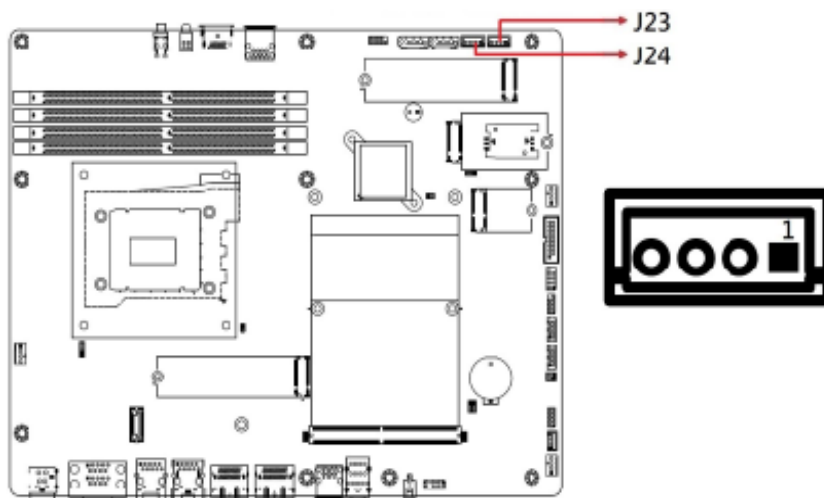

Pin	Signal Name	Pin	Signal Name
1	+5V	3	Ground
2	Ground	4	+12V

### 2.5.19 PWM Fan Power Connector (CPU\_FAN1, SYS\_FAN1, SYS\_FAN2)

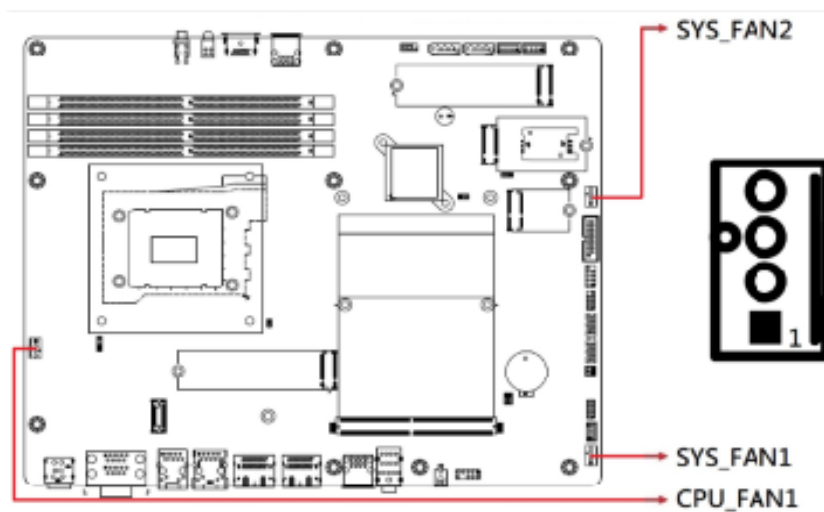

Pin	Signal Name
1	Ground
2	+12V
3	Rotation detection
4	Control

**2.5.20 CN9: MXM Connector**

Pin	Signal Name	Pin	Signal Name	Pin	Signal Name	Pin	Signal Name
E1	PWR_SRC	E2	PWR_SRC	141	PEX_RX1#	142	PEX_TX1#
E3	Ground	E4	Ground	143	PEX_RX1	144	PEX_TX1
1	5V	2	PRSNT_R#	145	Ground	146	Ground
3	5V	4	WAKE# (N/C)	147	PEX_RX0#	148	PEX_TX0#
5	5V	6	PWR_GOOD	149	PEX_RX0	150	PEX_TX0
7	5V	8	PWR_EN	151	Ground	152	Ground
9	5V	10	27MHZ_REF (N/C)	153	PEX_REFCLK#	154	PEX_CLK_REQ#
11	Ground	12	Ground	155	PEX_REFCLK	156	PEX_RST#
13	Ground	14	DP_F_HPD	157	Ground	158	VGA_DDC_DAT (N/C)
15	Ground	16	JTAG_TESTEN (N/C)	159	JTAG_TDO (N/C)	160	VGA_DDC_CLK (N/C)
17	Ground	18	PWR_LEVEL	161	JTAG_TDI (N/C)	162	VGA_VSYNC (N/C)
19	PEX_STD_SW#	20	TH_OVERT#	163	JTAG_TCLK (N/C)	164	VGA_HSYNC (N/C)
21	VGA_DISABLE#	22	TH_ALERT#	165	JTAG_TMS (N/C)	166	Ground
23	PNL_PWR_EN	24	TH_PWN	167	JTAG_TRST# (N/C)	168	VGA_RED (N/C)
25	PNL_BL_EN	26	GPIO0	169	DP_F_L3#	170	VGA_GREEN (N/C)
27	PNL_BL_PWN	28	GPIO1	171	DP_F_L3	172	VGA_BLUE (N/C)
29	HDMI_CEC (N/C)	30	GPIO2	173	Ground	174	Ground
31	DP_E_HPD	32	SMB_DAT	175	DP_F_AUX#	176	DP_E_L3#
33	I2C_DAT	34	SMB_CLK	177	DP_F_AUX	178	DP_E_L3
35	I2C_CLK	36	Ground	179	Ground	180	Ground
37	Ground	38	OEM0 (N/C)	181	DP_F_L0#	182	DP_E_AUX#
39	OEM1 (N/C)	40	OEM2 (N/C)	183	DP_F_L0	184	DP_E_AUX
41	OEM3 (N/C)	42	OEM4	185	Ground	186	Ground
43	OEM5	44	OEM6	187	DP_F_L1#	188	DP_E_L0#
45	OEM7	46	Ground	189	DP_F_L1	190	DP_E_L0
47	Ground	48	PEX_TX15#	191	Ground	192	Ground
49	PEX_RX15#	50	PEX_TX15	193	DP_F_L2#	194	DP_E_L1#
51	PEX_RX15	52	Ground	195	DP_F_L2	196	DP_E_L1
53	Ground	54	PEX_TX14#	197	Ground	198	Ground
55	PEX_RX14#	56	PEX_TX14	199	DP_C_L0#	200	DP_E_L2#
57	PEX_RX14	58	Ground	201	DP_C_L0	202	DP_E_L2
59	Ground	60	PEX_TX13#	203	Ground	204	Ground
61	PEX_RX13#	62	PEX_TX13	205	DP_C_L1#	206	DP_D_L0#
63	PEX_RX13	64	Ground	207	DP_C_L1	208	DP_D_L0
65	Ground	66	PEX_TX12#	209	Ground	210	Ground
67	PEX_RX12#	68	PEX_TX12	211	DP_C_L2#	212	DP_D_L1#

Pin	Signal Name	Pin	Signal Name	Pin	Signal Name	Pin	Signal Name
69	PEX_RX12	70	Ground	213	DP_C_L2	214	DP_D_L1
71	Ground	72	PEX_TX11#	215	Ground	216	Ground
73	PEX_RX11#	74	PEX_TX11	217	DP_C_L3#	218	DP_D_L2#
75	PEX_RX11	76	Ground	219	DP_C_L3	220	DP_D_L2
77	Ground	78	PEX_TX10#	221	Ground	222	Ground
79	PEX_RX10#	80	PEX_TX10	223	DP_C_AUX#	224	DP_D_L3#
81	PEX_RX10	82	Ground	225	DP_C_AUX	226	DP_D_L3
83	Ground	84	PEX_TX9#	227	RSVD (N/C)	228	Ground
85	PEX_RX9#	86	PEX_TX9	229	RSVD (N/C)	230	DP_D_AUX#
87	PEX_RX9	88	Ground	231	RSVD (N/C)	232	DP_D_AUX
89	Ground	90	PEX_TX8#	233	RSVD (N/C)	234	DP_C_HPD
91	PEX_RX8#	92	PEX_TX8	235	RSVD (N/C)	236	DP_D_HPD
93	PEX_RX8	94	Ground	237	RSVD (N/C)	238	RSVD (N/C)
95	Ground	96	PEX_TX7#	239	RSVD	240	3V3
97	PEX_RX7#	98	PEX_TX7	241	RSVD (N/C)	242	3V3
99	PEX_RX7	100	Ground	243	RSVD (N/C)	244	Ground
101	Ground	102	PEX_TX6#	245	RSVD (N/C)	246	DP_B_L0#
103	PEX_RX6#	104	PEX_TX6	247	RSVD (N/C)	248	DP_B_L0
105	PEX_RX6	106	Ground	249	RSVD (N/C)	250	Ground
107	Ground	108	PEX_TX5#	251	Ground	252	DP_B_L1#
109	PEX_RX5#	110	PEX_TX5	253	DP_A_L0#	254	DP_B_L1
111	PEX_RX5	112	Ground	255	DP_A_L0	256	Ground
113	Ground	114	PEX_TX4#	257	Ground	258	DP_B_L2#
115	PEX_RX4#	116	PEX_TX4	259	DP_A_L1#	260	DP_B_L2
117	PEX_RX4	118	Ground	261	DP_A_L1	262	Ground
119	Ground	120	PEX_TX3#	263	Ground	264	DP_B_L3#
121	PEX_RX3#	122	PEX_TX3	265	DP_A_L2#	266	DP_B_L3
123	PEX_RX3	124	Ground	267	DP_A_L2	268	Ground
125	Ground	126	KEY	269	Ground	270	DP_B_AUX#
127	KEY	128	KEY	271	DP_A_L3#	272	DP_B_AUX
129	KEY	130	KEY	273	DP_A_L3	274	DP_B_HPD
131	KEY	132	KEY	275	Ground	276	DP_A_HPD
133	Ground	134	Ground	277	DP_A_AUX#	278	3V3
135	PEX_RX2#	136	PEX_TX2#	279	DP_A_AUX	280	3V3
137	PEX_RX2	138	PEX_TX2	281	PRSNT_L#		
139	Ground	140	Ground				

## Chapter 3

# Driver Installation

The information provided in this chapter includes:

- Intel® Chipset Software Installation Utility
- HD Audio Driver Installation
- LAN Driver Installation
- Intel® Management Engine Component Drivers Installation
- NVIDIA® GeForce® MXM Driver Installation



### 3.1 Introduction

This section describes the installation procedures for software drivers. The software drivers are available on IBASE website [www.ibase.com.tw](http://www.ibase.com.tw). Go to the download page of the product. Copy the compressed drivers file to your computer. Double click the file to decompress it. Run “CDGuide” to go to the main drivers page.

**Note:** After installing your Windows operating system, you must install the Intel® Chipset Software Installation Utility first before proceeding with the drivers installation.

### 3.2 Intel® Chipset Software Installation Utility

The Intel® Chipset drivers should be installed first before the software drivers to install INF files for Plug & Play function for the chipset components. Follow the instructions below to complete the installation.

1. Run the **Setup.exe** file.
2. When the *Welcome* screen to the Intel® Chipset Device Software appears, click **Next** to continue.

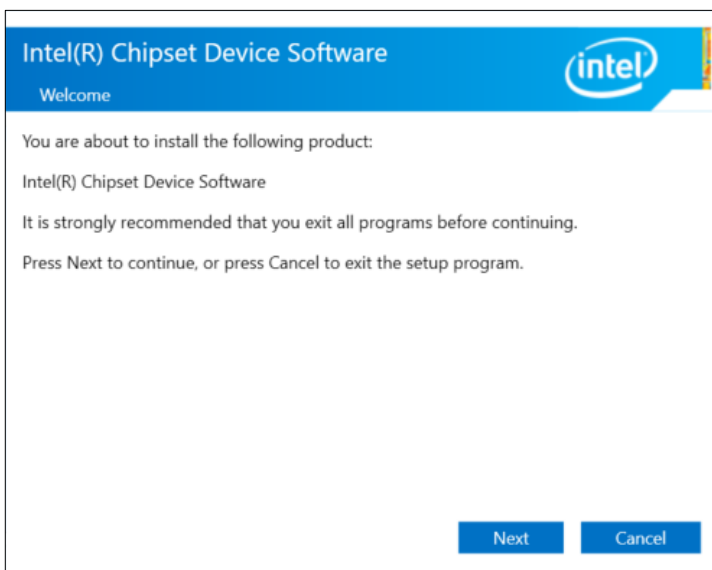

3. Accept the license agreement and proceed with the installation process.
4. When the driver is completely installed, restart the computer for changes to take effect.

## 3.3 HD Audio Driver Installation

1. Run the **Setup.exe** file.
2. On the *Welcome* screen of the InstallShield Wizard, click **Next**.

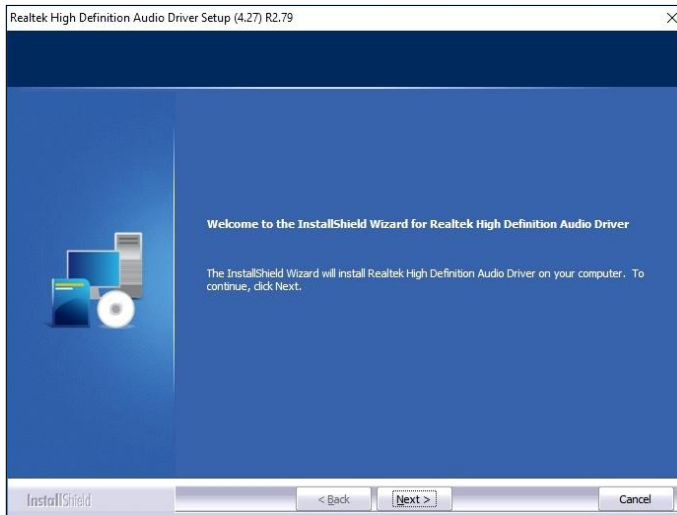

3. When the driver is completely installed, restart the computer for changes to take effect.

## 3.4 LAN Driver Installation

1. Run the **Setup.exe** file.
2. On the *Welcome* screen of the InstallShield Wizard, click **Next**.

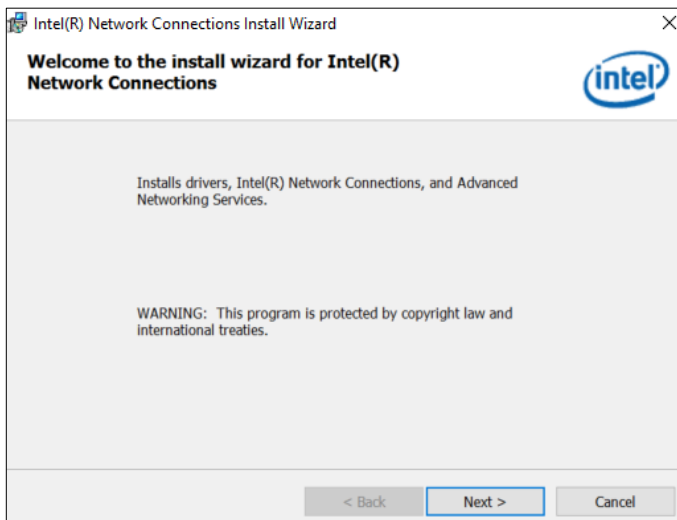

3. Accept the license agreement and click **Next** to continue.

On the *Setup Options* screen, tick the checkbox to select the desired driver(s) and click **Next** for installation. When the driver is completely installed, restart the computer for changes to take effect.

### 3.5 Intel® Management Engine Components Drivers Installation

1. Run the **Setup.exe** file.
2. When the *Welcome* screen appears, click **Next**.

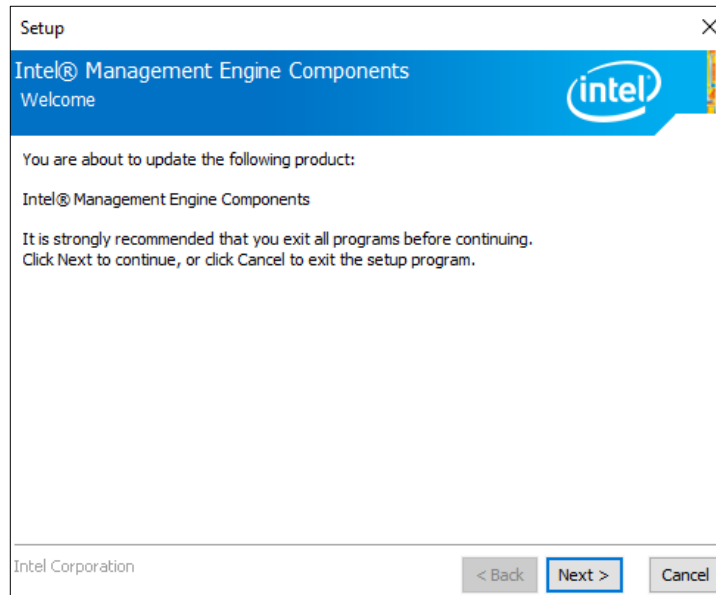

3. Accept the license agreement and click **Next** for installation.
4. The driver has been completely installed. Restart the computer for changes to take effect.

### 3.6 NVIDIA® GeForce® MXM Driver Installation

1. Download the driver from NVIDIA's website or IBASE's website.
2. Accept the software license agreement and start installation.
3. Click **Close** to finish the installation.

## Chapter 4

# BIOS Setup

This chapter describes the different settings available in the AMI BIOS that comes with the board. The topics covered in this chapter are as follows:

- Main Settings
- Advanced Settings
- Chipset Settings
- Security Settings
- Boot Settings
- Save & Exit

## 4.1 Introduction

The BIOS (Basic Input/Output System) installed in the ROM of your computer system supports Intel® processors. The BIOS provides critical low-level support for standard devices such as disk drives, serial ports and parallel ports. It also provides password protection as well as special support for detailed fine-tuning of the chipset controlling the entire system.

## 4.2 BIOS Setup

The BIOS provides a Setup utility program for specifying the system configurations and settings. The BIOS ROM of the system stores the Setup utility. When you turn on the computer, the BIOS is immediately activated. Press the <Del> key immediately allows you to enter the Setup utility. If you are a little bit late pressing the <Del> key, POST (Power On Self Test) will continue with its test routines, thus preventing you from invoking the Setup.

If you still need to enter Setup, restart the system by pressing the "Reset" button or simultaneously pressing the <Ctrl>, <Alt> and <Delete> keys. You can also restart by turning the system Off and back On again.

The following message will appear on the screen:

```
Press <DEL> to Enter Setup
```

In general, press the arrow keys to highlight items, <Enter> to select, the <PgUp> and <PgDn> keys to change entries, <F1> for help, and <Esc> to quit.

When you enter the BIOS Setup utility, the Main Menu screen will appear on the screen. The Main Menu allows you to select from various setup functions and exit choices.

---

**Warning:** Making changes to the chipset defaults is strongly discouraged. These defaults, set by AMI and your system manufacturer, are optimized for maximum performance and reliability. Altering these settings could potentially make the system unstable and lead to crashes.

---

### 4.3 Main Settings



BIOS Setting	Description
System Date	Sets the date. Use the <Tab> key to switch between the date elements.
System Time	Set the time. Use the <Tab> key to switch between the time elements.

## 4.4 Advanced Settings

This section allows you to configure, improve your system and allows you to set up some system features according to your preference.

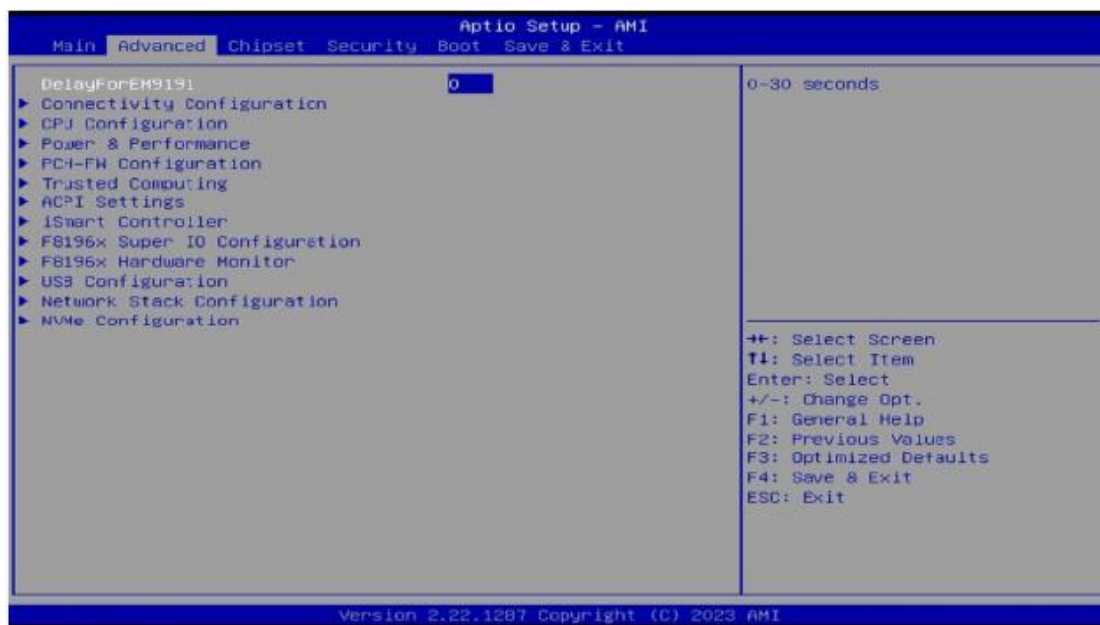

### 4.4.1 ACPI Settings



BIOS Setting	Description
Enable Hibernation	Enables or Disables System ability to hibernate (OS/S4 Sleep State). This option may not be effective with some OS.
ACPI Sleep State	Select the highest ACPI sleep state the system will enter when the SUSPEND button is pressed.



### 4.4.2 Connectivity Configuration



BIOS Setting	Description
RFI Mitigation	This is an option intended to enable/disable DDR-RFIM feature for connectivity. This RFI mitigation feature may result in temporary slowdown of the DDR speed.
Preboot BLE	This will be used to enable Preboot Bluetooth function
Discrete Bluetooth Interface	Seriallo UART0 needs to be enabled to select BT interface.
BT Tile Mode	Enable/Disable Tile
Advanced settings	Configure ACPI objects for wireless devices.
WWAN Configuration	Configure WWAN related options
WWAN Device	Select the M.2 WWAN device options to enable 4G – 7360/7560 (Intel), 4G – MB0 (MediaTek) Modems

### 4.4.3 CPU Configuration



BIOS Setting	Description
Intel (VMX) Virtualization Technology	When enabled, a VMM can utilize the additional hardware capabilities provided by Vanderpool Technology.
Active Performance Cores	Number of P-cores to enable in each processor package. Note: Number of cores and E-cores are looked at together. When both are [0,0], Pcode will enable all cores.
Hyper-Threading	Enable or Disable Hyper-Threading Technology

### 4.4.4 F8196x Hardware Monitor

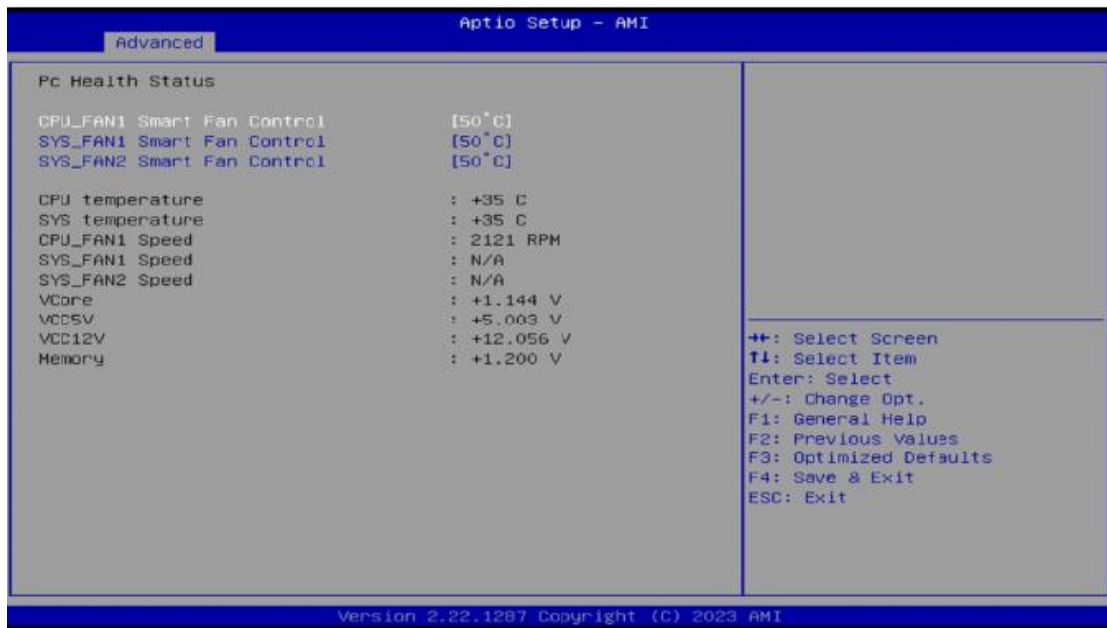

BIOS Setting	Description
CPU Smart Fan Control	Disable or set fan control for CPU_FAN1 at 50°C, 60°C, 70°C or 80°C.
Temperatures / Voltages	These fields are the parameters of the hardware monitoring function feature of the motherboard. The values are read-only values as monitored by the system and show the PC health status.

### 4.4.5 F8996x Super IO Configuration

Advanced		Aptio Setup - AMI	
<b>F8196x Super IO Configuration</b> Super IO Chip: F8196x ▶ Serial Port 1 Configuration ▶ Serial Port 2 Configuration ▶ Serial Port 3 Configuration ▶ Serial Port 4 Configuration ▶ Serial Port 5 Configuration		Set Parameters of Serial Port 1 (COMA)          ++: Select Screen ↑↓: Select Item Enter: Select +/-: Change Opt. F1: General Help F2: Previous Values F3: Optimized Defaults F4: Save & Exit ESC: Exit	
Version 2.22.1287 Copyright (C) 2023 AMI			

<b>F8196x Super IO Configuration</b> Super IO Chip: F8196x ▶ Serial Port 1 Configuration ▶ Serial Port 2 Configuration ▶ Serial Port 3 Configuration ▶ Serial Port 4 Configuration ▶ Serial Port 5 Configuration		Set Parameters of Serial Port 2 (COMB)	
--	--	--	--

<b>F8196x Super IO Configuration</b> Super IO Chip: F8196x ▶ Serial Port 1 Configuration ▶ Serial Port 2 Configuration ▶ Serial Port 3 Configuration ▶ Serial Port 4 Configuration ▶ Serial Port 5 Configuration		Set Parameters of Serial Port 3 (COMC)	
--	--	--	--

<b>F8196x Super IO Configuration</b> Super IO Chip: F8196x ▶ Serial Port 1 Configuration ▶ Serial Port 2 Configuration ▶ Serial Port 3 Configuration ▶ Serial Port 4 Configuration ▶ Serial Port 5 Configuration		Set Parameters of Serial Port 4 (COMD)	
--	--	--	--

<b>F8196x Super IO Configuration</b> Super IO Chip: F8196x ▶ Serial Port 1 Configuration ▶ Serial Port 2 Configuration ▶ Serial Port 3 Configuration ▶ Serial Port 4 Configuration ▶ Serial Port 5 Configuration		Set Parameters of Serial Port 4 (COMD)	
--	--	--	--

## 4.4.6 iSmart Controller



BIOS Setting	Description
Power-On after Power failure	Enables / Disables the system to be turned on automatically after a power failure.
PWR Resume Delay	Enables / Disables Power on resume delay
Temperature Guardian	Default: Disable
Schedule Slot 1 / 2	<p>Sets up the hour / minute for system power-on.</p> <p><b>Important:</b> If you would like to set up a schedule between adjacent days, configure two schedule slots.</p> <p>For example, if setting up a schedule from Wednesday 5 p.m. to Thursday 2 a.m., configure two schedule slots. But if setting up a schedule from 3 p.m to 5 p.m. on Wednesday, configure only a schedule slot.</p>

### 4.4.7 Network Stack Configuration



BIOS Setting	Description
Network Stack	Enables / Disables UEFI Network Stack.

### 4.4.8 PCH-FW Configuration

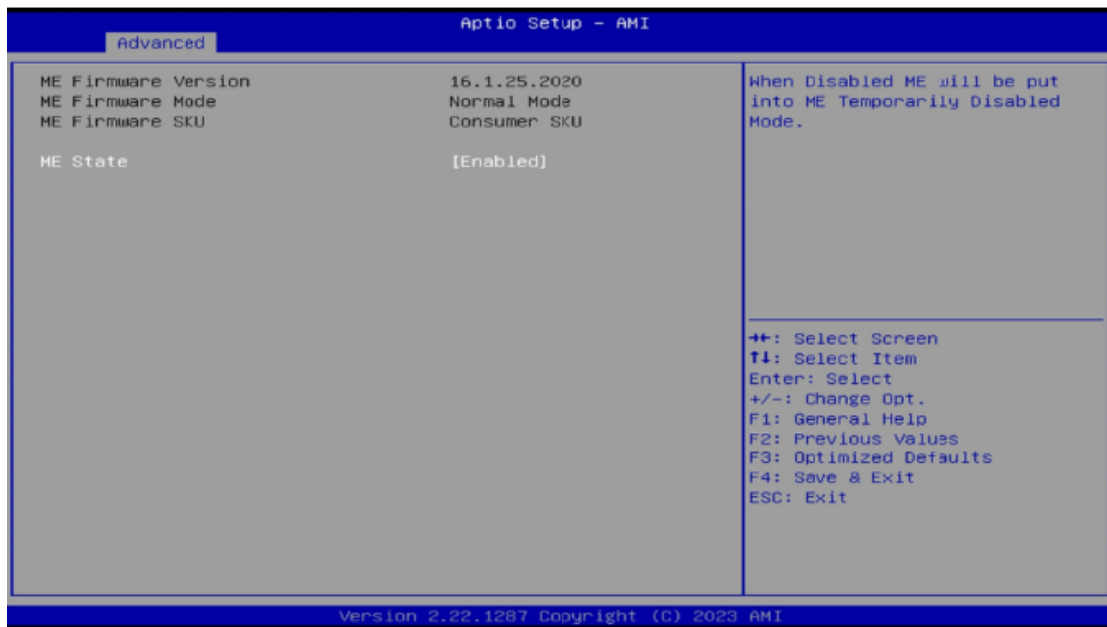

### 4.4.9 Power & Performance



<p>CPU - Power Management Control</p> <p>Intel(R) SpeedStep(tm) [Enabled]                  Intel(R) Speed Shift Technology [Enabled]                  Turbo Mode [Enabled]</p>	<p>Allows more than two frequency ranges to be supported.</p>
<p>CPU - Power Management Control</p> <p>Intel(R) SpeedStep(tm) [Enabled]                  Intel(R) Speed Shift Technology [Enabled]                  Turbo Mode [Enabled]</p>	<p>Enable/Disable Intel(R) Speed Shift Technology support. Enabling will expose the CPPC v2 interface to allow for hardware controlled P-states.</p>
<p>CPU - Power Management Control</p> <p>Intel(R) SpeedStep(tm) [Enabled]                  Intel(R) Speed Shift Technology [Enabled]                  Turbo Mode [Enabled]</p>	<p>Enable/Disable processor Turbo Mode (requires EMTTM enabled too). AUTO means enabled.</p>

BIOS Setting	Description
CPU – Power Management Control	CPU power management control options.
Intel(R) Speed Shift Technology Turbo Mode	Allows more than two frequency ranges to be supported.
Intel (R) Speed Shift Technology	Enable/Disable Intel(R) Speed Shift Technology support. Enabling will expose the CPPC v2 interface to allow for hardware controlled P-states.
Turbo Mode	Enable/Disable processor Turbo Mode (requires EMTTM enabled too). AUTO means enabled.

### 4.4.10 Trusted Computing

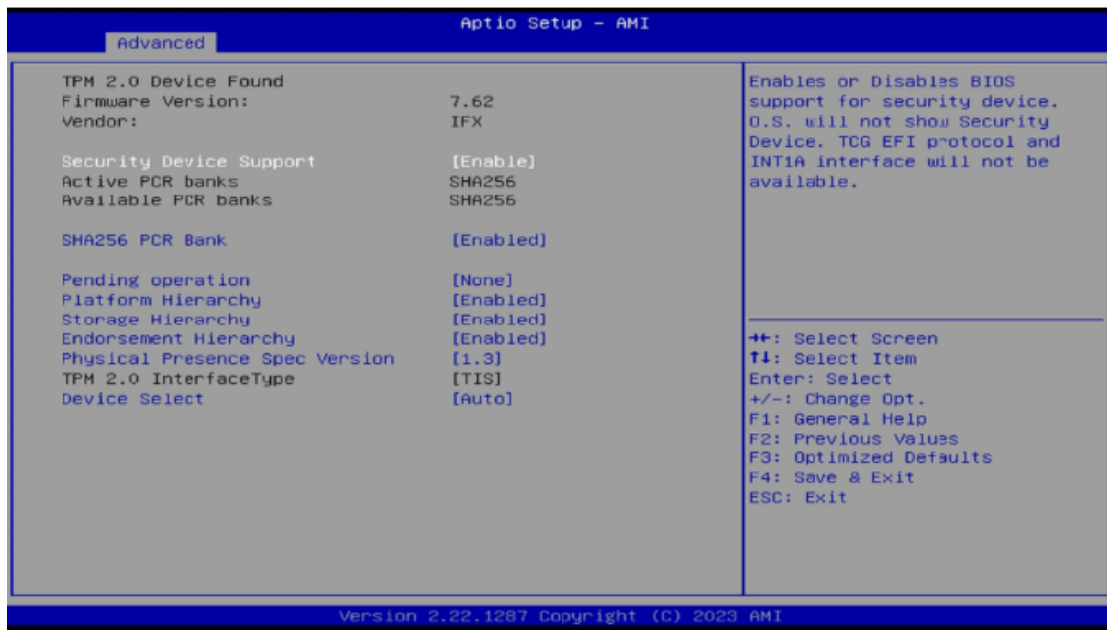

BIOS Setting	Description
Security Device Support	Enables / Disables BIOS support for security device. OS will not show security device. TCG EFI protocol and INT1A interface will not be available.
SHA256 PCR Bank	Enables / Disables SHA256 PCR Bank.
Pending operation	Schedule an operation for the security device. Note: Your computer will reboot during restart in order to change state of security device.
Platform Hierarchy	Enables / Disables platform hierarchy.
Storage Hierarchy	Enables / Disables storage hierarchy.
Endorsement Hierarchy	Enables / Disables endorsement hierarchy.
Physical Presence Spec Version	Select to tell O.S. to support PPI Spec Version 1.2 or 1.3. Note some HCK tests might not support 1.3.
Device Select	TPM 1.2 will restrict support to TPM 1.2 devices. TPM 2.0 will restrict support to TPM 2.0 devices. Auto will support both with the default set to TPM 2.0 devices if not found, TPM 1.2 devices will be enumerated.



### 4.4.11 USB Configuration

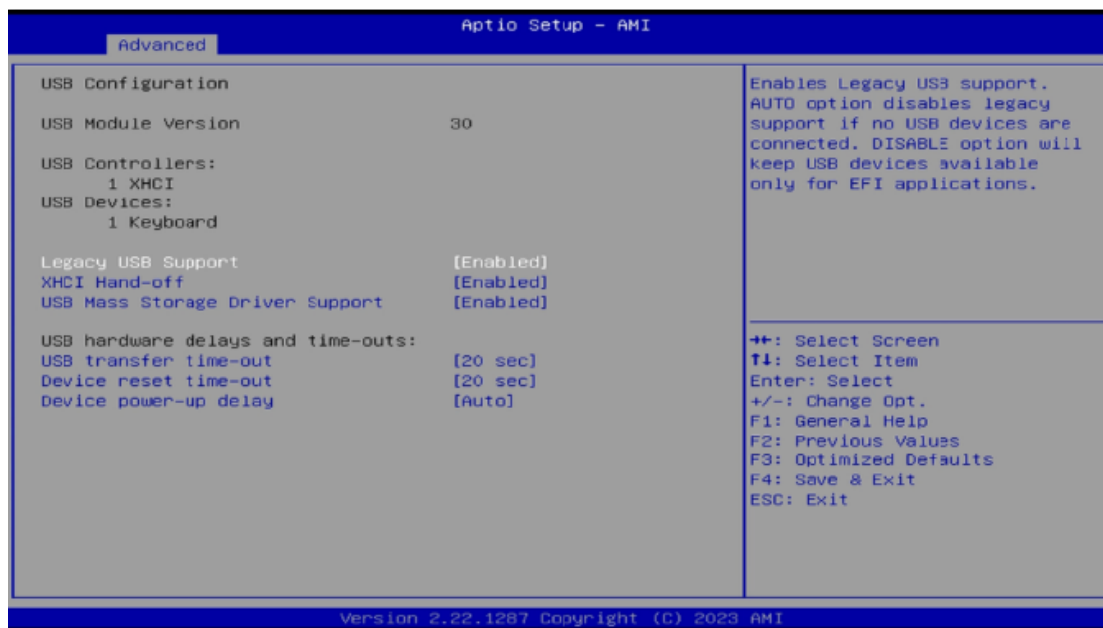

BIOS Setting	Description
Legacy USB Support	<ul style="list-style-type: none"> <li>• <b>Enable:</b> Enables Legacy USB Support.</li> <li>• <b>Auto:</b> Disables legacy support if no USB devices are connected.</li> <li>• <b>Disable:</b> Keeps USB devices available only for EFI applications.</li> </ul>
XHCI Hand-off	This is a workaround for OSEs without XHCI hand-off support. The XHCI ownership change should be claimed by XHCI driver.
USB Mass Storage Driver Support	Enables / Disables the support for USB mass storage driver.
USB Transfer time-out	The time-out value for Control, Bulk, and Interrupt transfers.
Device reset time-out	Seconds of delaying execution of start unit command to USB mass storage device.
Device power-up delay	The maximum time the device will take before it properly reports itself to the Host Controller. "Auto" uses default value for a Root port it is 100ms. But for a Hub port, the delay is taken from Hub descriptor.

### 4.4.12 Network Stack Configuration



## 4.5 Chipset Settings

### 4.5.1 System Agent (SA) Configuration

Aptio Setup - AMI	
Main Advanced <b>Chipset</b> Security Boot Save & Exit	
▶ System Agent (SA) Configuration	System Agent (SA) Parameters
▶ PCH-IO Configuration	

#### 4.5.1.1. Graphics Configuration:

System Agent (SA) Configuration	Graphics Configuration
VT-d Supported	
▶ Graphics Configuration	
▶ VMD setup menu	
VT-d [Enabled]	
Control Iommu Pre-boot Behavior [Disable IOHMMU]	

System Agent (SA) Configuration	VMD Configuration settings
VT-d Supported	
▶ Graphics Configuration	
▶ VMD setup menu	
VT-d [Enabled]	
Control Iommu Pre-boot Behavior [Disable IOHMMU]	

System Agent (SA) Configuration	VT-d capability
VT-d Supported	
▶ Graphics Configuration	
▶ VMD setup menu	
VT-d [Enabled]	
Control Iommu Pre-boot Behavior [Disable IOHMMU]	

System Agent (SA) Configuration	Enable IOHMMU in Pre-boot environment (If DMAR table is installed in DXE and If VTD_INFO_PPI is installed in PEI.)
VT-d Supported	
▶ Graphics Configuration	
▶ VMD setup menu	
VT-d [Enabled]	
Control Iommu Pre-boot Behavior [Disable IOHMMU]	

### 4.5.2 PCH-IO Configuration

Aptio Setup - AMI	
Main Advanced <b>Chipset</b> Security Boot Save & Exit	
▶ System Agent (SA) Configuration	PCH Parameters
▶ PCH-IO Configuration	
PCH-IO Configuration	SATA Device Options Settings
▶ SATA Configuration	
▶ USB Configuration	

**4.5.2.1 SATA Configuration:**

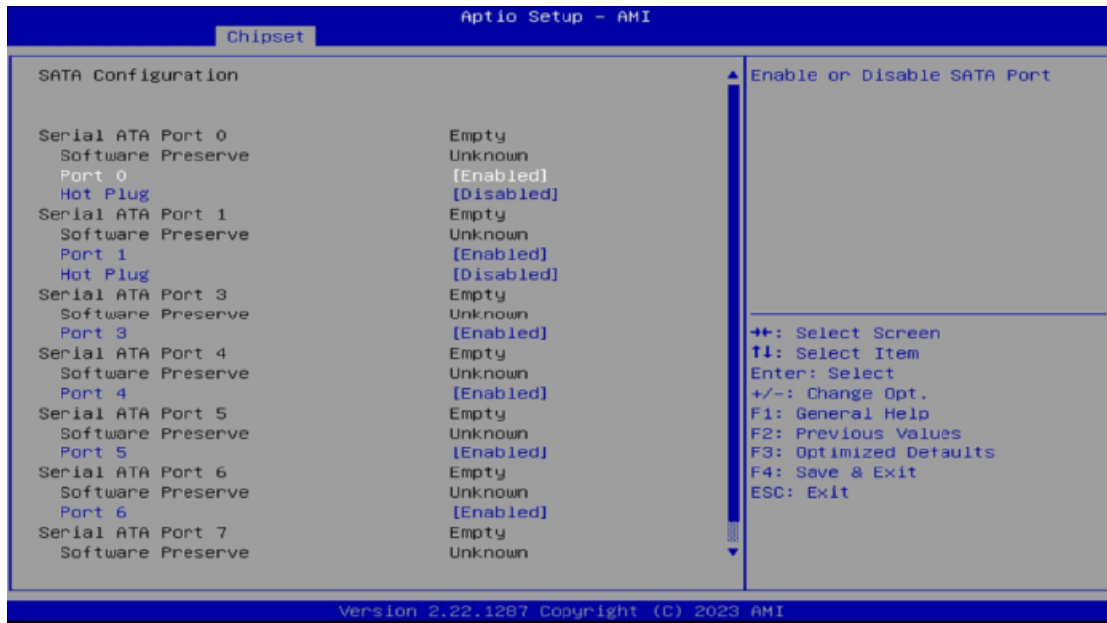

BIOS Setting	Description
SATA Configuration	SATA device options and settings
Serial ATA Port	Enables / Disables Serial Port
Hot Plug	Designates the port as Hot Pluggable.

**4.5.2.2 USB Configuration:**

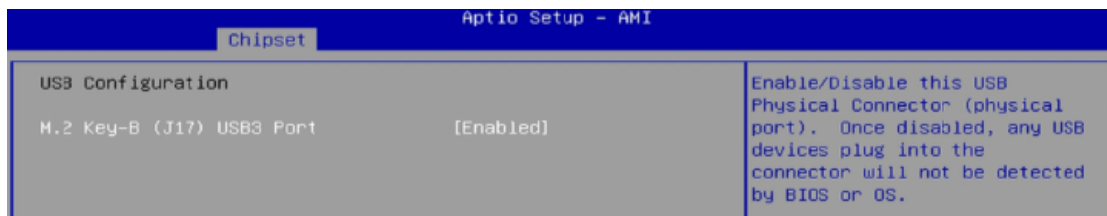

## 4.6 Security Settings

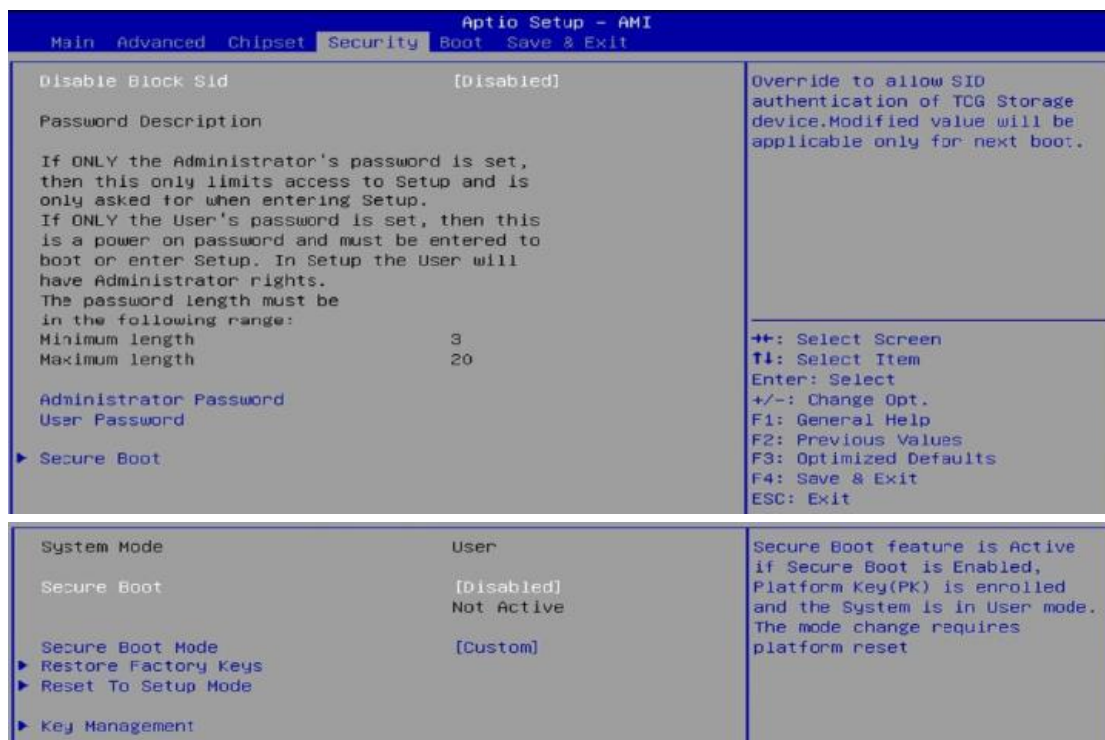

BIOS Setting	Description
Setup Administrator Password	Sets an administrator password for the setup utility.
User Password	Sets a user password.
Secure Boot	Secure Boot feature is Active if Secure Boot is enabled. Platform Key(PK) is enrolled and the system is in user mode. The mode change requires platform reset.
Secure Boot Mode	Secure Boot mode options: Standard or Custom. In Custom mode, Secure Boot Policy variables can be configured by a physically present user without full authentication.
Restore Factory Keys	Force system to User Mode. Install factory default Secure Boot key databases.
Reset To Setup Mode	Delete all Secure Boot key databases from NVRAM.
Key Management	Enables expert users to modify Secure Boot Policy variables without variable authentication.

## 4.7 Boot Settings

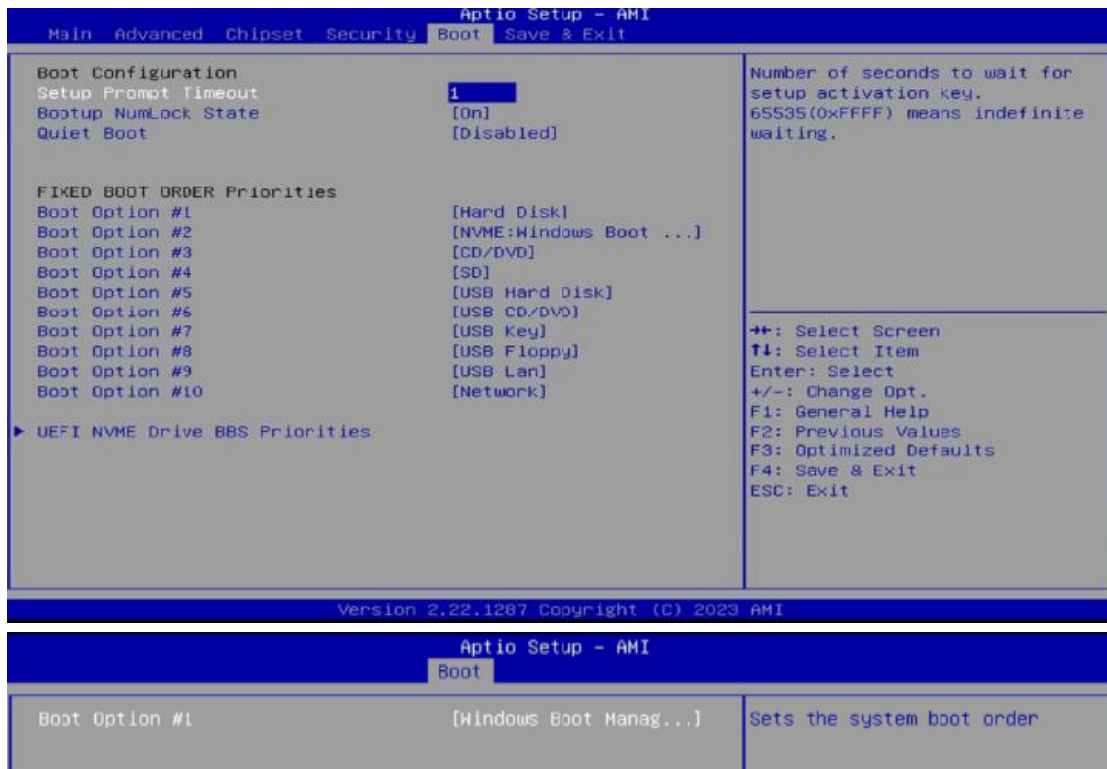

BIOS Setting	Description
Setup Prompt Timeout	Number of seconds to wait for setup activation key. 65535 (0xFFFF) means indefinite waiting.
Bootup NumLock State	Selects the keyboard NumLock state.
Quiet Boot	Enables / Disables Quiet Boot option.
FIXED BOOT ORDER Priorities	Sets the system boot order.
UEFI NVME Drive BBS Priorities	Specifies the Boot Device Priority sequence from available UEFI NVME Drives.
Boot Option #1	Sets the system boot order

## 4.8 Save & Exit Settings

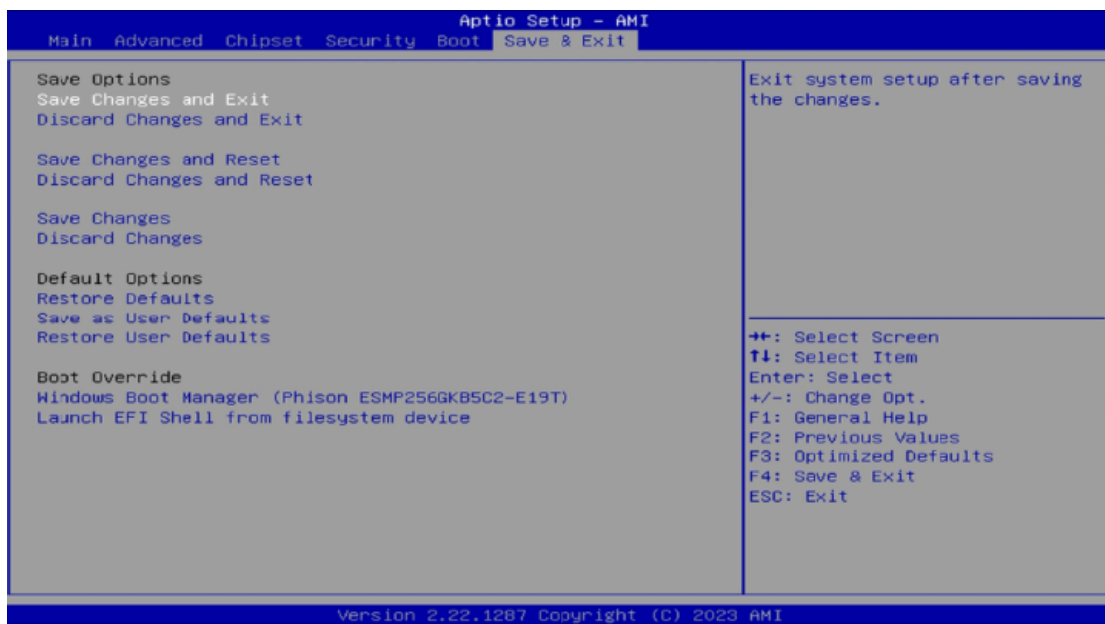

BIOS Setting	Description
Save Changes and Exit	Exits system setup after saving the changes.
Discard Changes and Exit	Exits system setup without saving any changes.
Save Changes and Reset	Resets the system after saving the changes.
Discard Changes and Reset	Resets system setup without saving any changes.
Save Changes	Saves changes done so far to any of the setup options.
Discard Changes	Discards changes done so far to any of the setup options.
Restore Defaults	Restores / Loads defaults values for all the setup options.
Save as User Defaults	Saves the changes done so far as User Defaults.
Restore User Defaults	Restores the user defaults to all the setup options.
Launch EFI Shell from filesystem device	Attempts to launch EFI shell application (Shell.efi) from one of the available filesystem devices.

## Appendix

This section provides the mapping addresses of peripheral devices and the sample code of watchdog timer configuration.

- I/O Port Address Map
- Interrupt Request Lines (IRQ)
- Watchdog Timer Configuration



## A. I/O Port Address Map

Each peripheral device in the system is assigned a set of I/O port addresses which also becomes the identity of the device. The following table lists the I/O port addresses used.

Address	Device Description
0x00000A00-0x00000A0F	Motherboard resources
0x00000A10-0x00000A1F	Motherboard resources
0x00000A20-0x00000A2F	Motherboard resources
0x0000002E-0x0000002F	Motherboard resources
0x0000004E-0x0000004F	Motherboard resources
0x00000061-0x00000061	Motherboard resources
0x00000063-0x00000063	Motherboard resources
0x00000065-0x00000065	Motherboard resources
0x00000067-0x00000067	Motherboard resources
0x00000070-0x00000070	Motherboard resources
0x00000080-0x00000080	Motherboard resources
0x00000092-0x00000092	Motherboard resources
0x000000B2-0x000000B3	Motherboard resources
0x00000680-0x0000069F	Motherboard resources
0x0000164E-0x0000164F	Motherboard resources
0x00001854-0x00001857	Motherboard resources
0x00000020-0x00000021	Programmable interrupt controller
0x00000024-0x00000025	Programmable interrupt controller
0x00000028-0x00000029	Programmable interrupt controller
0x0000002C-0x0000002D	Programmable interrupt controller
0x00000030-0x00000031	Programmable interrupt controller
0x00000034-0x00000035	Programmable interrupt controller
0x00000038-0x00000039	Programmable interrupt controller
0x0000003C-0x0000003D	Programmable interrupt controller
0x000000A0-0x000000A1	Programmable interrupt controller
0x000000A4-0x000000A5	Programmable interrupt controller
0x000000A8-0x000000A9	Programmable interrupt controller
0x000000AC-0x000000AD	Programmable interrupt controller
0x000000B0-0x000000B1	Programmable interrupt controller

Address	Device Description
0x000000B4-0x000000B5	Programmable interrupt controller
0x000000B8-0x000000B9	Programmable interrupt controller
0x000000BC-0x000000BD	Programmable interrupt controller
0x000004D0-0x000004D1	Programmable interrupt controller
0x00005000-0x00005FFF	Intel(R) PEG10 - 460D
0x00005000-0x00005FFF	NVIDIA RTX A4500 Embedded GPU
0x000003F8-0x000003FF	Communications Port (COM1)
0x000002F8-0x000002FF	Communications Port (COM2)
0x000003E8-0x000003EF	Communications Port (COM3)
0x000002E8-0x000002EF	Communications Port (COM4)
0x000003E0-0x000003E7	Communications Port (COM5)
0x0000EFA0-0x0000EFBF	Intel(R) SMBus - 7AA3
0x00006050-0x00006057	Standard SATA AHCI Controller
0x00006040-0x00006043	Standard SATA AHCI Controller
0x00006020-0x0000603F	Standard SATA AHCI Controller
0x00000000-0x00000CF7	PCI Express Root Complex
0x00000D00-0x0000FFFF	PCI Express Root Complex
0x00004000-0x00004FFF	Intel(R) PCI Express Root Port #3 - 7ABA
0x00000040-0x00000043	System timer
0x00000050-0x00000053	System timer
0x00003000-0x00003FFF	Intel(R) PCI Express Root Port #8 - 7ABF
0x00002000-0x000020FE	Motherboard resources
0x000000B4-0x000000B5	Programmable interrupt controller
0x000000B8-0x000000B9	Programmable interrupt controller
0x000000BC-0x000000BD	Programmable interrupt controller
0x000004D0-0x000004D1	Programmable interrupt controller
0x00005000-0x00005FFF	Intel(R) PEG10 - 460D
0x00005000-0x00005FFF	NVIDIA RTX A4500 Embedded GPU
0x00000040-0x00000043	System timer
0x00000050-0x00000053	System timer
0x00003000-0x00003FFF	Intel(R) PCI Express Root Port #8 - 7ABF
0x00002000-0x000020FE	Motherboard resources

## B. Interrupt Request Lines (IRQ)

Peripheral devices use interrupt request lines to notify CPU for the service required. The following table shows the IRQ used by the devices on board.

Level	Function
IRQ 4294967274	Intel(R) USB 3.20 eXtensible Host Controller - 1.20 (Microsoft)
IRQ 4294967276~88	Standard NVM Express Controller
IRQ 4294967258	Intel(R) Management Engine Interface #1
IRQ 4294967292	Intel(R) PCI Express Root Port #4 - 7ABB
IRQ 4294967294	Intel(R) PEG10 - 460D
IRQ 4	Communications Port (COM1)
IRQ 3	Communications Port (COM2)
IRQ 7	Communications Port (COM3)
IRQ 6	Communications Port (COM4)
IRQ 10	Communications Port (COM5)
IRQ 4294967289	Standard SATA AHCI Controller
IRQ 4294967290	Intel(R) PCI Express Root Port #13 - 7AB4
IRQ 4294967275	NVIDIA RTX A4500 Embedded GPU
IRQ 17	High Definition Audio Controller
IRQ 17	High Definition Audio Controller
IRQ 4294967293	Intel(R) PCI Express Root Port #3 - 7ABA
IRQ 4294967259~65	Intel(R) Ethernet Controller I226-V
IRQ 55~511	Microsoft ACPI-Compliant System
IRQ 109	Trusted Platform Module 2.0
IRQ 0	System timer
IRQ 4294967291	Intel(R) PCI Express Root Port #8 - 7ABF
IRQ 4294967266~73	Intel(R) I210 Gigabit Network Connection

## C. Watchdog Timer Configuration

The Watchdog Timer (WDT) is used to generate a variety of output signals after a user programmable count. The WDT is suitable for the use in the prevention of system lock-up, such as when software becomes trapped in a deadlock. Under these sorts of circumstances, the timer will count to zero and the selected outputs will be driven. Under normal circumstance, you will need to restart the WDT at regular intervals before the timer counts to zero.

### Sample Code:

```
//-----  
//  
// THIS CODE AND INFORMATION IS PROVIDED "AS IS" WITHOUT WARRANTY OF ANY  
// KIND, EITHER EXPRESSED OR IMPLIED, INCLUDING BUT NOT LIMITED TO THE  
// IMPLIED WARRANTIES OF MERCHANTABILITY AND/OR FITNESS FOR A PARTICULAR  
// PURPOSE.  
//  
//-----  
#include <dos.h>  
#include <conio.h>  
#include <stdio.h>  
#include <stdlib.h>  
#include "F81966.H"  
//-----  
int main (int argc, char *argv[]);  
void EnableWDT(int);  
void DisableWDT(void);  
//-----  
int main (int argc, char *argv[])  
{  
    unsigned char bBuf;  
    unsigned char bTime;  
    char **endptr;  
  
    char SIO;  
  
    printf("Fintek 81966 watch dog program\n");  
    SIO = Init_F81966();  
    if (SIO == 0)  
    {  
        printf("Can not detect Fintek 81966, program abort.\n");  
        return(1);  
    }/if (SIO == 0)  
  
    if (argc != 2)  
    {  
        printf(" Parameter incorrect!!\n");  
        return (1);  
    }  
    bTime = strtol (argv[1], endptr, 10);  
    printf("System will reset after %d seconds\n", bTime);
```

```

    if (bTime)
    { EnableWDT(bTime); }
    else
    { DisableWDT(); }
    return 0;
}
//-----
void EnableWDT(int interval)
{
    unsigned char bBuf;

    bBuf = Get_F81966_Reg(0x2B);
    bBuf &= (~0x20);
    Set_F81966_Reg(0x2B, bBuf); //Enable WDTO

    Set_F81966_LD(0x07); //switch to logic device 7
    Set_F81966_Reg(0x30, 0x01); //enable timer

    bBuf = Get_F81966_Reg(0xF5);
    bBuf &= (~0x0F);
    bBuf |= 0x52;
    Set_F81966_Reg(0xF5, bBuf); //count mode is second

    Set_F81966_Reg(0xF6, interval); //set timer

    bBuf = Get_F81966_Reg(0xFA);
    bBuf |= 0x01;
    Set_F81966_Reg(0xFA, bBuf); //enable WDTO output

    bBuf = Get_F81966_Reg(0xF5);
    bBuf |= 0x20;
    Set_F81966_Reg(0xF5, bBuf); //start counting
}
//-----
void DisableWDT(void)
{
    unsigned char bBuf;

    Set_F81966_LD(0x07); //switch to logic device 7

    bBuf = Get_F81966_Reg(0xFA);
    bBuf &= ~0x01;
    Set_F81966_Reg(0xFA, bBuf); //disable WDTO output

    bBuf = Get_F81966_Reg(0xF5);
    bBuf &= ~0x20;
    bBuf |= 0x40;
    Set_F81966_Reg(0xF5, bBuf); //disable WDT
}
//-----

```

# iBASE

```
//-----  
//  
// THIS CODE AND INFORMATION IS PROVIDED "AS IS" WITHOUT WARRANTY OF ANY  
// KIND, EITHER EXPRESSED OR IMPLIED, INCLUDING BUT NOT LIMITED TO THE  
// IMPLIED WARRANTIES OF MERCHANTABILITY AND/OR FITNESS FOR A  
// PARTICULAR  
// PURPOSE.  
//  
//-----  
#include "F81966.H"  
#include <dos.h>  
//-----  
unsigned int F81966_BASE;  
void Unlock_F81966 (void);  
void Lock_F81966 (void);  
//-----  
unsigned int Init_F81966(void)  
{  
    unsigned int result;  
    unsigned char ucDid;  
  
    F81966_BASE = 0x4E;  
    result = F81966_BASE;  
  
    ucDid = Get_F81966_Reg(0x20);  
    if (ucDid == 0x07)        //Fintek 81966  
    { goto    Init_Finish; }  
  
    F81966_BASE = 0x2E;  
    result = F81966_BASE;  
  
    ucDid = Get_F81966_Reg(0x20);  
    if (ucDid == 0x07)        //Fintek 81966  
    { goto    Init_Finish; }  
  
    F81966_BASE = 0x00;  
    result = F81966_BASE;  
  
Init_Finish:  
    return (result);  
}  
//-----  
void Unlock_F81966 (void)  
{  
    outportb(F81966_INDEX_PORT, F81966_UNLOCK);  
    outportb(F81966_INDEX_PORT, F81966_UNLOCK);  
}  
//-----  
void Lock_F81966 (void)  
{  
    outportb(F81966_INDEX_PORT, F81966_LOCK);  
}  
//-----  
void Set_F81966_LD( unsigned char LD)
```

```

{
    Unlock_F81966();
    outportb(F81966_INDEX_PORT, F81966_REG_LD);
    outportb(F81966_DATA_PORT, LD);
    Lock_F81966();
}
//-----
void Set_F81966_Reg( unsigned char REG, unsigned char DATA)
{
    Unlock_F81966();
    outportb(F81966_INDEX_PORT, REG);
    outportb(F81966_DATA_PORT, DATA);
    Lock_F81966();
}
//-----
unsigned char Get_F81966_Reg(unsigned char REG)
{
    unsigned char Result;
    Unlock_F81966();
    outportb(F81966_INDEX_PORT, REG);
    Result = inportb(F81966_DATA_PORT);
    Lock_F81966();
    return Result;
}
//-----
//-----
//
// THIS CODE AND INFORMATION IS PROVIDED "AS IS" WITHOUT WARRANTY OF ANY
// KIND, EITHER EXPRESSED OR IMPLIED, INCLUDING BUT NOT LIMITED TO THE
// IMPLIED WARRANTIES OF MERCHANTABILITY AND/OR FITNESS FOR A
// PARTICULAR
// PURPOSE.
//
//-----
#ifndef F81966_H
#define F81966_H      1
//-----
#define F81966_INDEX_PORT  (F81966_BASE)
#define F81966_DATA_PORT   (F81966_BASE+1)
//-----
#define F81966_REG_LD      0x07
//-----
#define F81966_UNLOCK      0x87
#define F81966_LOCK        0xAA
//-----
unsigned int Init_F81966(void);
void Set_F81966_LD( unsigned char);
void Set_F81966_Reg( unsigned char, unsigned char);
unsigned char Get_F81966_Reg( unsigned char);
//-----
#endif // F81966_H

```