

# PIC-H61

Full Size PICMG 1.3  
User's Manual

## Copyright

This publication contains information that is protected by copyright. No part of it may be reproduced in any form or by any means or used to make any transformation/adaptation without the prior written permission from the copyright holders.

This publication is provided for informational purposes only. The manufacturer makes no representations or warranties with respect to the contents or use of this manual and specifically disclaims any express or implied warranties of merchantability or fitness for any particular purpose. The user will assume the entire risk of the use or the results of the use of this document. Further, the manufacturer reserves the right to revise this publication and make changes to its contents at any time, without obligation to notify any person or entity of such revisions or changes.

Changes after the publication's first release will be based on the product's revision. The website will always provide the most updated information.

© 2014. All Rights Reserved.

## Trademarks

Product names or trademarks appearing in this manual are for identification purpose only and are the properties of the respective owners.

## FCC and DOC Statement on Class B

This equipment has been tested and found to comply with the limits for a Class B digital device, pursuant to Part 15 of the FCC rules. These limits are designed to provide reasonable protection against harmful interference when the equipment is operated in a residential installation. This equipment generates, uses and can radiate radio frequency energy and, if not installed and used in accordance with the instruction manual, may cause harmful interference to radio communications. However, there is no guarantee that interference will not occur in a particular installation. If this equipment does cause harmful interference to radio or television reception, which can be determined by turning the equipment off and on, the user is encouraged to try to correct the interference by one or more of the following measures:

- Reorient or relocate the receiving antenna.
- Increase the separation between the equipment and the receiver.
- Connect the equipment into an outlet on a circuit different from that to which the receiver is connected.
- Consult the dealer or an experienced radio TV technician for help.

## Notice:

1. The changes or modifications not expressly approved by the party responsible for compliance could void the user's authority to operate the equipment.
2. Shielded interface cables must be used in order to comply with the emission limits.

## Table of Contents

Copyright.....	2
Trademarks .....	2
FCC and DOC Statement on Class B.....	2
About this Manual .....	4
Warranty .....	4
Static Electricity Precautions.....	4
Safety Measures.....	4
About the Package.....	5
Chapter 1 - Introduction.....	6
Specifications .....	6
Features .....	7
Chapter 2 - Hardware Installation.....	8
Board Layout.....	8
System Memory.....	9
Installing the DIM Module.....	10
CPU .....	11
Installing the CPU.....	11
Installing the Fan and Heat Sink.....	13
Jumper Settings .....	14
Clear CMOS .....	14
USB Power Select.....	15
KB/MS Power Select.....	15
Power-on Select.....	16
COM1 RS232/422/485 Select.....	16
Rare Panel I/O Ports.....	17
COM (Serial) Ports.....	17
USB Ports.....	18
RJ45 LAN Ports.....	18
VGA Ports .....	19
I/O Connectors .....	20
Digital I/O Power Connector.....	20
Digital I/O Connector .....	20
Cooling Fan Connectors.....	21
Chassis Intrusion Connector .....	21
Front Panel Connector .....	22

LPT Connector.....	22
FPD Connector .....	23
KB/MS Connector.....	23
IrDA Connector .....	24
SMBus Connector .....	24
Power Connectors.....	25
Battery.....	25

Chapter 3 - BIOS Setup.....	26
Overview .....	26
AMI BIOS Setup Utility.....	27
Main .....	27
Advanced .....	27
Chipset .....	35
Boot.....	39
Security.....	40
Save & Exit .....	41
Updating the BIOS .....	41
Chapter 4 - Supported Software .....	42
Appendix A - Watchdog Sample Code.....	53
Appendix B - Troubleshooting .....	54
Appendix C - Troubleshooting .....	55
Appendix D - BIOS Status Code.....	57

## About this Manual

An electronic file of this manual is included in the CD. To view the user's manual in the CD, insert the CD into a CD-ROM drive. The autorun screen (Main Board Utility CD) will appear. Click "User's Manual" on the main menu.

## Warranty

1. Warranty does not cover damages or failures that arised from misuse of the product, inability to use the product, unauthorized replacement or alteration of components and product specifications.
2. The warranty is void if the product has been subjected to physical abuse, improper installation, modification, accidents or unauthorized repair of the product.
3. Unless otherwise instructed in this user's manual, the user may not, under any circumstances, attempt to perform service, adjustments or repairs on the product, whether in or out of warranty. It must be returned to the purchase point, factory or authorized service agency for all such work.
4. We will not be liable for any indirect, special, incidental or consequential damages to the product that has been modified or altered.

## Static Electricity Precautions

It is quite easy to inadvertently damage your PC, system board, components or devices even before installing them in your system unit. Static electrical discharge can damage computer components without causing any signs of physical damage. You must take extra care in handling them to ensure against electrostatic build-up.

1. To prevent electrostatic build-up, leave the system board in its anti-static bag until you are ready to install it.
2. Wear an antistatic wrist strap.
3. Do all preparation work on a static-free surface.
4. Hold the device only by its edges. Be careful not to touch any of the components, contacts or connections.
5. Avoid touching the pins or contacts on all modules and connectors. Hold modules or connectors by their ends.



### Important:

Electrostatic discharge (ESD) can damage your processor, disk drive and other components. Perform the upgrade instruction procedures described at an ESD workstation only. If such a station is not available, you can provide some ESD protection by wearing an antistatic wrist strap and attaching it to a metal part of the system chassis. If a wrist strap is unavailable, establish and maintain contact with the system chassis throughout any procedures requiring ESD protection.

## Safety Measures

To avoid damage to the system:

- Use the correct AC input voltage range.

To reduce the risk of electric shock:

- Unplug the power cord before removing the system chassis cover for installation or servicing. After installation or servicing, cover the system chassis before plugging the power cord.

## About the Package

The package contains the following items. If any of these items are missing or damaged, please contact your dealer or sales representative for assistance.

- One PIC-H61 board
- Two USB port cables (with bracket)
- Two COM port cables (with bracket)
- Two Serial ATA data cables
- One DVD
- One QR (Quick Reference)

## Optional Items

- Serial ATA data cable
- Serial ATA power cable
- USB port cable
- COM port cable

The board and accessories in the package may not come similar to the information listed above. This may differ in accordance to the sales region or models in which it was sold. For more information about the standard package in your region, please contact your dealer or sales representative.

## Before Using the System Board

Before using the system board, prepare basic system components.

If you are installing the system board in a new system, you will need at least the following internal components.

- A CPU
- Memory module
- Storage devices such as hard disk drive, CD-ROM, etc.

You will also need external system peripherals you intend to use which will normally include at least a keyboard, a mouse and a video display monitor.

# Chapter 1 - Introduction

## Specifications

<b>Processor</b>	<ul style="list-style-type: none"> <li>LGA 1155 socket for:             <ul style="list-style-type: none"> <li>3rd generation Intel® Core™ processors (22nm process technology)                 <ul style="list-style-type: none"> <li>Intel® Core™ i7-3770 (8M Cache, up to 3.9 GHz); 77W</li> <li>Intel® Core™ i5-3550S (6M Cache, up to 3.7 GHz); 65W</li> <li>Intel® Core™ i3-3220 (3M Cache, 3.3 GHz); 55W</li> </ul> </li> <li>Intel® Pentium® G2120 (3M Cache, 3.1 GHz); 65W</li> </ul> </li> <li>2nd generation Intel® Core™ processors (32nm process technology)                 <ul style="list-style-type: none"> <li>Intel® Core™ i7-2600 (8M Cache, up to 3.8 GHz); 95W</li> <li>Intel® Core™ i5-2400 (6M Cache, up to 3.4 GHz); 95W</li> <li>Intel® Core™ i3-2120 (3M Cache, 3.3 GHz); 65W</li> <li>Intel® Pentium® G850 (3M Cache, 2.9 GHz); 65W</li> </ul> </li> <li>Intel® Advanced Vector Extensions (Intel® AVX) Instructions</li> <li>Intel® Turbo Boost Technology</li> </ul>
<b>Chipset</b>	<ul style="list-style-type: none"> <li>Intel® H61 Express Chipset</li> </ul>
<b>System Memory</b>	<ul style="list-style-type: none"> <li>Two 240-pin DDR3 DIMM sockets</li> <li>Supports DDR3 1333/1600MHz (3rd generation processors)</li> <li>Supports DDR3 1066/1333MHz (2nd generation processors)</li> <li>Supports dual channel memory interface</li> <li>Supports up to 16GB system memory</li> <li>DRAM device technologies: 1Gb, 2Gb and 4Gb DDR3 DRAM technologies are supported for x8 and x16 devices, unbuffered, non-ECC</li> </ul>
<b>Expansion Interfaces (via gold fingers)</b>	<ul style="list-style-type: none"> <li>1 PCIe x16 slot             <ul style="list-style-type: none"> <li>Supports Gen 3.0 (3rd generation processors)</li> <li>Supports Gen 2.0 (2nd generation processors)</li> </ul> </li> <li>4 PCIe x1</li> <li>4 PCI</li> <li>4 USB 2.0</li> </ul>
<b>Graphics</b>	<ul style="list-style-type: none"> <li>Intel® HD Graphics</li> <li>Display outputs:             <ul style="list-style-type: none"> <li>1 VGA port at rear I/O</li> <li>1 TMDS port pin header supports PIC-DVI module (optional)</li> </ul> </li> <li>DVI-D supports up to 1920x1080 @ 60Hz resolution (optional)</li> <li>VGA supports up to 2048x1536 @ 75Hz resolution</li> <li>Supports 6 Graphics Execution Units (EUs)</li> <li>Intel® Clear Video Technology</li> <li>DirectX Video Acceleration (DXVA) support for accelerating video processing</li> </ul>
<b>LAN</b>	<ul style="list-style-type: none"> <li>2 Intel® W82574L PCI Express Gigabit Ethernet controllers</li> <li>Integrated 10/100/1000 transceiver</li> <li>Fully compliant with IEEE 802.3, IEEE 802.3u, IEEE 802.3ab</li> </ul>
<b>Onboard USB</b>	<ul style="list-style-type: none"> <li>6 USB 2.0             <ul style="list-style-type: none"> <li>2 USB at the rear I/O</li> <li>4 USB via 2 USB connectors</li> </ul> </li> </ul>
<b>Trusted Platform Module - TPM (optional)</b>	<ul style="list-style-type: none"> <li>Infineon SLB9635</li> <li>Provides a Trusted PC for secure transactions</li> <li>Provides software license protection, enforcement and password protection</li> </ul>

<b>Serial ATA</b>	<ul style="list-style-type: none"> <li>4 SATA 2.0 ports with data transfer rate up to 3Gb/s</li> </ul>
<b>BIOS</b>	<ul style="list-style-type: none"> <li>AMI BIOS             <ul style="list-style-type: none"> <li>64Mbit SPI BIOS</li> </ul> </li> </ul>
<b>Rear I/O</b>	<ul style="list-style-type: none"> <li>1 DB-15 VGA port</li> <li>2 RJ45 LAN ports</li> <li>2 USB 2.0/1.1 ports</li> </ul>
<b>I/O Connectors</b>	<ul style="list-style-type: none"> <li>1 PS/2 Keyboard/Mouse connector</li> <li>4 serial connectors             <ul style="list-style-type: none"> <li>1 RS232/422/485</li> <li>3 RS232</li> </ul> </li> <li>4 SATA 2.0 ports</li> <li>1 parallel connector</li> <li>1 floppy connector</li> <li>2 connectors for 4 USB 2.0/1.1 ports</li> <li>1 8-bit Digital I/O connector</li> <li>1 SMBus connector</li> <li>1 IrDA connector</li> <li>1 front panel connector</li> <li>1 chassis intrusion connector</li> <li>1 CPU fan connector (supports Smart fan)</li> <li>1 8-pin 12V ATX power connector</li> </ul>
<b>Energy Efficient Design</b>	<ul style="list-style-type: none"> <li>Supports ErP Lot6 power saving (optional)</li> <li>Supports ACPI</li> <li>System Power Management</li> <li>Wake-On-Events include:             <ul style="list-style-type: none"> <li>Wake-On-PS/2 KB/Mouse</li> <li>Wake-On-USB KB/Mouse</li> <li>Wake-On-LAN</li> <li>RTC timer to power-on the system</li> </ul> </li> <li>CPU stopped clock control</li> <li>AC power failure recovery</li> </ul>
<b>Damage Free Intelligence</b>	<ul style="list-style-type: none"> <li>Monitors CPU/system temperature and overheat alarm</li> <li>Monitors VCore/5V/3.3V/V_DIMM/12V/5VSB voltages and failure alarm</li> <li>Monitors CPU/system fan speed and failure alarm</li> <li>Read back capability that displays temperature, voltage and fan speed</li> <li>Watchdog timer function</li> </ul>
<b>OS Support</b>	<ul style="list-style-type: none"> <li>Windows XP Professional x86 &amp; SP3 (32-bit)</li> <li>Windows XP Professional x64 &amp; SP2 (64-bit)</li> <li>Windows 7 Ultimate x86 &amp; SP1 (32-bit)</li> <li>Windows 7 Ultimate x64 &amp; SP1 (64-bit)</li> </ul>
<b>Temperature</b>	<ul style="list-style-type: none"> <li>Operating: 0°C to 60°C</li> <li>Storage: -20°C to 85°C</li> </ul>
<b>Humidity</b>	<ul style="list-style-type: none"> <li>10% to 90%</li> </ul>
<b>Dimensions</b>	<ul style="list-style-type: none"> <li>338mm (13.3") x 122mm (4.8")</li> </ul>
<b>Certification</b>	<ul style="list-style-type: none"> <li>CE</li> <li>FCC Class B</li> <li>RoHS</li> </ul>

## Features

- **Watchdog Timer**

The Watchdog Timer function allows your application to regularly “clear” the system at the set time interval. If the system hangs or fails to function, it will reset at the set time interval so that your system will continue to operate.

- **DDR3**

DDR3 delivers increased system bandwidth and improved performance. The advantages of DDR3 are its higher bandwidth and its increase in performance at a lower power than DDR2.

- **Graphics**

The integrated Intel® HD graphics engine delivers an excellent blend of graphics performance and features to meet business needs. It provides excellent video and 3D graphics with outstanding graphics responsiveness. These enhancements deliver the performance and compatibility needed for today’s and tomorrow’s business applications. Supports DVI-D and VGA interfaces for display outputs.

- **Serial ATA**

Serial ATA is a storage interface that is compliant with SATA 1.0a specification. With speed of up to 3Gb/s (SATA 2.0), it improves hard drive performance faster than the standard parallel ATA whose data transfer rate is 100MB/s.

- **Gigabit LAN**

The Intel W82574L Gigabit LAN controller supports up to 1Gbps data transmission.

- **Wake-On-LAN**

This feature allows the network to remotely wake up a Soft Power Down (Soft-Off) PC. It is supported via the onboard LAN port or via a PCI LAN card that uses the PCI PME (Power Management Event) signal. However, if your system is in the Suspend mode, you can power-on the system only through an IRQ or DMA interrupt.



**Important:**  
The 5V\_standby power source of your power supply must support  $\geq 720\text{mA}$ .

- **USB**

The system board supports USB 2.0 and USB 1.1 ports. USB 1.1 supports 12Mb/second bandwidth while USB 2.0 supports 480Mb/second bandwidth providing a marked improvement in device transfer speeds between your computer and a wide range of simultaneously accessible external Plug and Play peripherals.

- **Wake-On-PS/2**

This function allows you to use the PS/2 keyboard or PS/2 mouse to power-on the system.



**Important:**  
The 5V\_standby power source of your power supply must support  $\geq 720\text{mA}$ .

- **Wake-On-USB**

This function allows you to use a USB keyboard or USB mouse to wake up a system from the S3 (STR - Suspend To RAM) state.



**Important:**  
If you are using the Wake-On-USB Keyboard/Mouse function for 2 USB ports, the 5V\_standby power source of your power supply must support  $\geq 1.5\text{A}$ . For 3 or more USB ports, the 5V\_standby power source of your power supply must support  $\geq 2\text{A}$ .

- **RTC Timer**

The RTC installed on the system board allows your system to automatically power-on on the set date and time.

- **ACPI STR**

The system board is designed to meet the ACPI (Advanced Configuration and Power Interface) specification. ACPI has energy saving features that enables PCs to implement Power Management and Plug-and-Play with operating systems that support OS Direct Power Management. ACPI when enabled in the Power Management Setup will allow you to use the Suspend to RAM function.

With the Suspend to RAM function enabled, you can power-off the system at once by pressing the power button or selecting “Standby” when you shut down Windows® without having to go through the sometimes tiresome process of closing files, applications and operating system. This is because the system is capable of storing all programs and data files during the entire operating session into RAM (Random Access Memory) when it powers-off. The operating session will resume exactly where you left off the next time you power-on the system.



**Important:**  
The 5V\_standby power source of your power supply must support  $\geq 720\text{mA}$ .

- **Power Failure Recovery**

When power returns after an AC power failure, you may choose to either power-on the system manually or let the system power-on automatically.

## Chapter 2 - Hardware Installation

### Board Layout

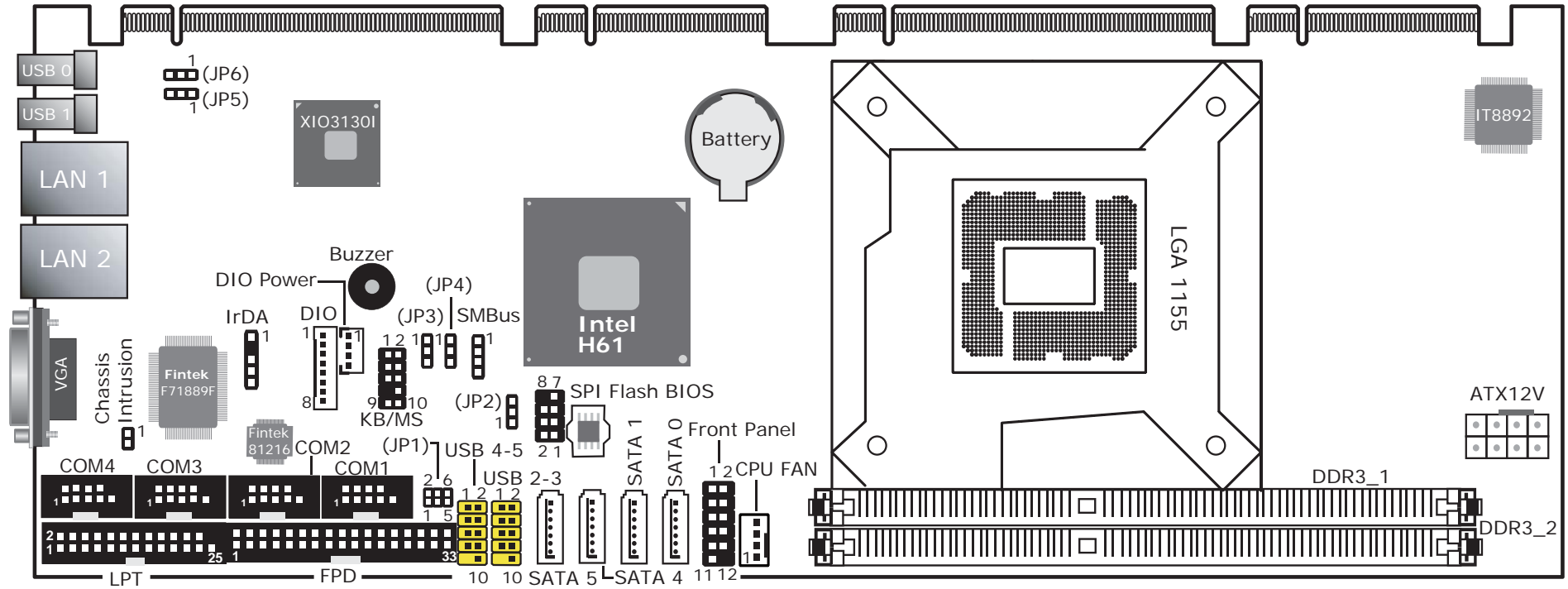



**Important:**

Electrostatic discharge (ESD) can damage your board, processor, disk drives, add-in boards, and other components. Perform installation procedures at an ESD workstation only. If such a station is not available, you can provide some ESD protection by wearing an antistatic wrist strap and attaching it to a metal part of the system chassis. If a wrist strap is unavailable, establish and maintain contact with the system chassis throughout any procedures requiring ESD protection.

## System Memory

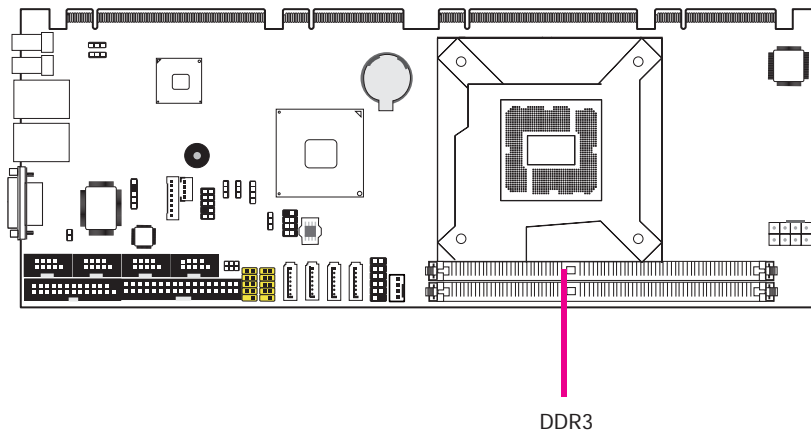

### Features

- Two 240-pin DDR3 DIMM sockets
- Supports 1066/1333/1600 MHz DDR3 SDRAM
- Dual channel memory interface
- Supports maximum of 16GB system memory

The system board supports the following memory interface.

#### Single Channel (SC)

Data will be accessed in chunks of 64 bits (8B) from the memory channels.

#### Dual Channel (DC)

Data will be accessed in chunks of 128 bits from the memory channels. Dual channel provides better system performance because it doubles the data transfer rate.

<b>Single Channel</b>	DIMMs are on the same channel. DIMMs in a channel can be identical or completely different. However, we highly recommend using identical DIMMs. Not all slots need to be populated.
<b>Dual Channel</b>	DIMMs of the same memory configuration are on different channels.

**Important:**

You can populate either Channel A or Channel B first.

## Installing the DIM Module



### Note:

The system board used in the following illustrations may not resemble the actual board. These illustrations are for reference only.

1. Make sure the PC and all other peripheral devices connected to it has been powered down.
2. Disconnect all power cords and cables.
3. Locate the DIMM socket on the system board.
4. Push the "ejector tabs" which are at the ends of the socket to the side.



5. Note how the module is keyed to the socket.

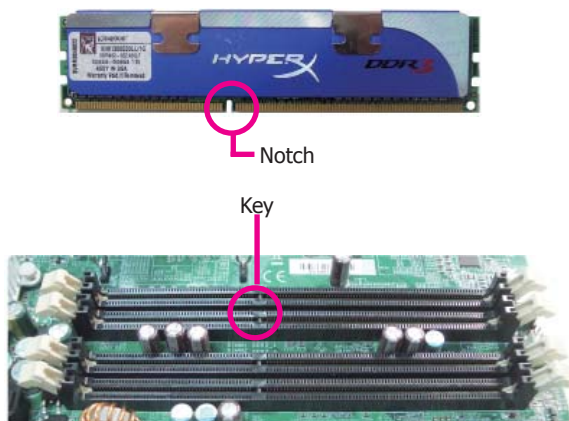

6. Grasping the module by its edges, position the module above the socket with the "notch" in the module aligned with the "key" on the socket. The keying mechanism ensures the module can be plugged into the socket in only one way.

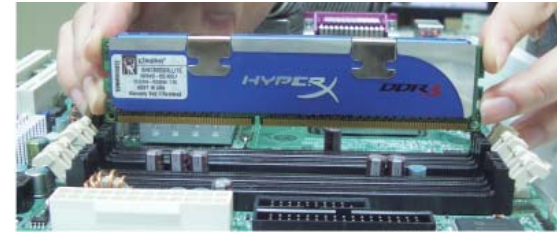

7. Seat the module vertically, pressing it down firmly until it is completely seated in the socket. The ejector tabs at the ends of the socket will automatically snap into the locked position to hold the module in place.



## CPU

The system board is equipped with a surface mount LGA 1155 socket. This socket is exclusively designed for installing a LGA 1155 packaged Intel CPU.



### Important:

1. Before you proceed, make sure (1) the LGA 1155 socket comes with a protective cap, (2) the cap is not damaged and (3) the socket's contact pins are not bent. If the cap is missing or the cap and/or contact pins are damaged, contact your dealer immediately.
2. Make sure to keep the protective cap. RMA requests will be accepted and processed only if the LGA 1155 socket comes with the protective cap.



### Note:

The system board used in the following illustrations may not resemble the actual board. These illustrations are for reference only.

## Installing the CPU

1. Make sure the PC and all other peripheral devices connected to it has been powered down.
2. Disconnect all power cords and cables.
3. Locate the LGA 1155 CPU socket on the system board.

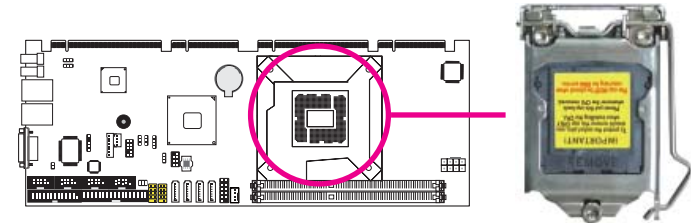

### Important:

The CPU socket must not come in contact with anything other than the CPU. Avoid unnecessary exposure. Remove the protective cap only when you are about to install the CPU.

4. Unlock the socket by pushing the load lever down, moving it sideways until it is released from the retention tab; then lift the load lever up.



- Lifting the load lever will at the same time lift the load plate.

Lift the load lever up to the angle shown on the photo.

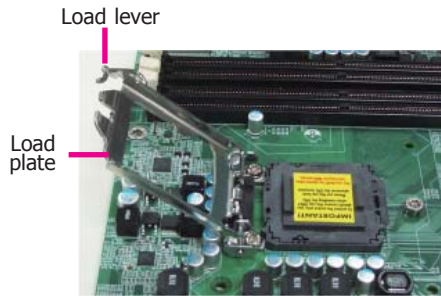

- Remove the protective cap from the CPU socket. The cap is used to protect the CPU socket against dust and harmful particles. Remove the protective cap only when you are about to install the CPU.

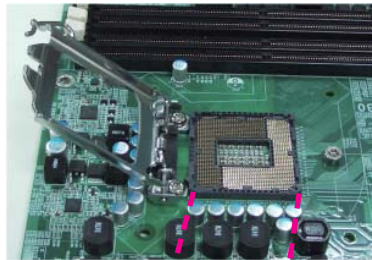

- Insert the CPU into the socket. The gold triangular mark on the CPU must align with the corner of the CPU socket shown on the photo.

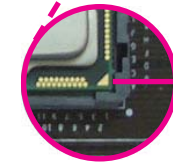

Gold triangular mark

The CPU's notch will at the same time fit into the socket's alignment key.

Alignment key

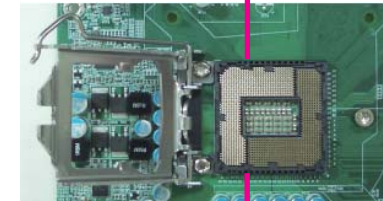

Alignment key



**Important:**

The CPU will fit in only one orientation and can easily be inserted without exerting any force.

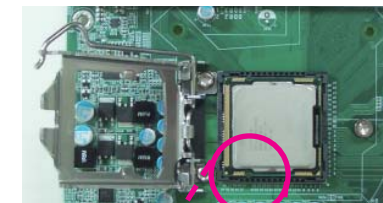

8. Close the load plate then push the load lever down.

While closing the load plate, make sure the front edge of the load plate slides under the retention knob.



9. Hook the load lever under the retention tab.

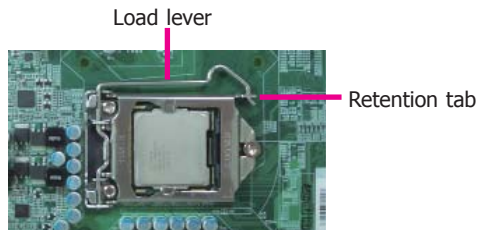

## Installing the Fan and Heat Sink

The CPU must be kept cool by using a CPU fan with heat sink. Without sufficient air circulation across the CPU and heat sink, the CPU will overheat damaging both the CPU and system board.



### Note:

A boxed Intel® processor already includes the CPU fan and heat sink assembly. If your CPU was purchased separately, make sure to only use Intel®-certified fan and heat sink.

1. Before you install the fan / heat sink, you must apply a thermal paste onto the top of the CPU. The thermal paste is usually supplied when you purchase the fan / heat sink assembly. Do not spread the paste all over the surface. When you later place the heat sink on top of the CPU, the compound will disperse evenly.

Some heat sinks come with a patch of pre-applied thermal paste. Do not apply thermal paste if the fan / heat sink already has a patch of thermal paste on its underside. Peel the strip that covers the paste before you place the fan / heat sink on top of the CPU.

2. Place the heat sink on top of the CPU. The 4 push-pins around the heat sink, which are used to secure the heat sink onto the system board, must match the 4 mounting holes around the socket.

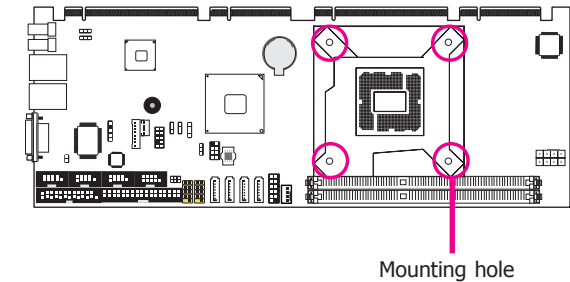

3. Orient the heat sink such that the CPU fan's cable is nearest the CPU fan connector.

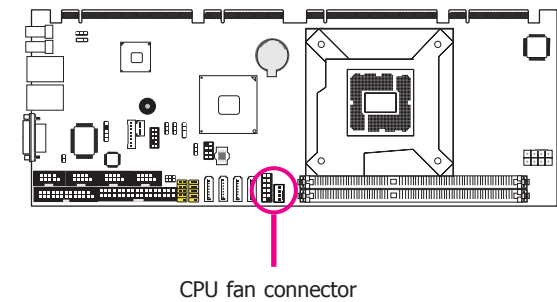

- Rotate each push-pin according to the direction of the arrow shown on top of the pin.

Push down two pushpins that are diagonally across the heat sink. Perform the same procedure for the other two push-pins.

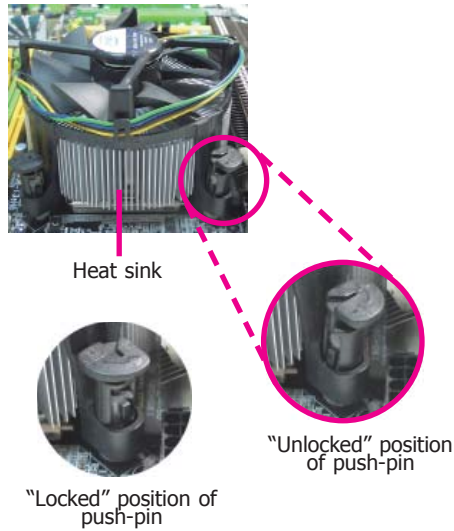

- Connect the CPU fan's cable to the CPU fan connector on the system board.

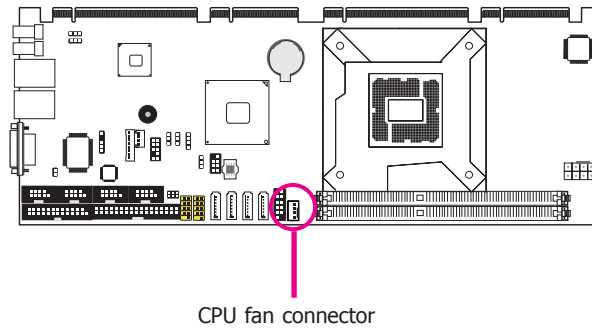

## Jumper Settings

### Clear CMOS

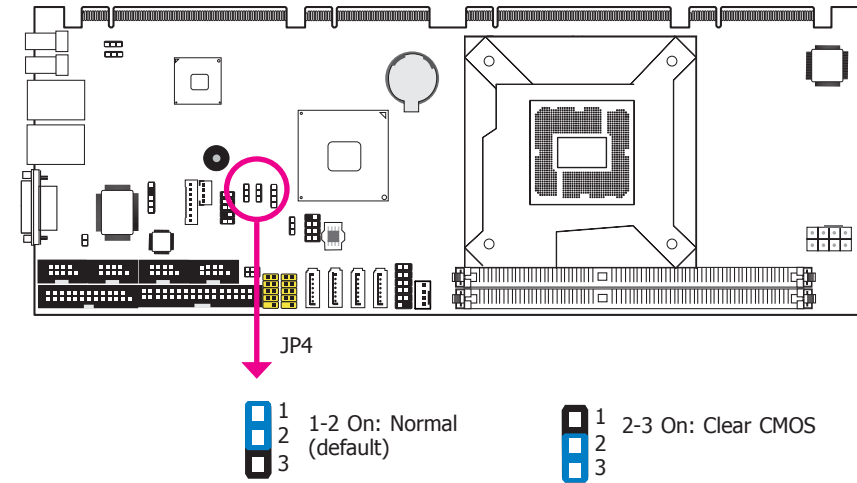

If you encounter the following,

- CMOS data becomes corrupted.
- You forgot the supervisor or user password.

you can reconfigure the system with the default values stored in the ROM BIOS.

To load the default values stored in the ROM BIOS, please follow the steps below.

- Power-off the system and unplug the power cord.
- Set JP4 pins 2 and 3 to On. Wait for a few seconds and set JP4 back to its default setting, pins 1 and 2 On.
- Now plug the power cord and power-on the system.



### USB Power Select

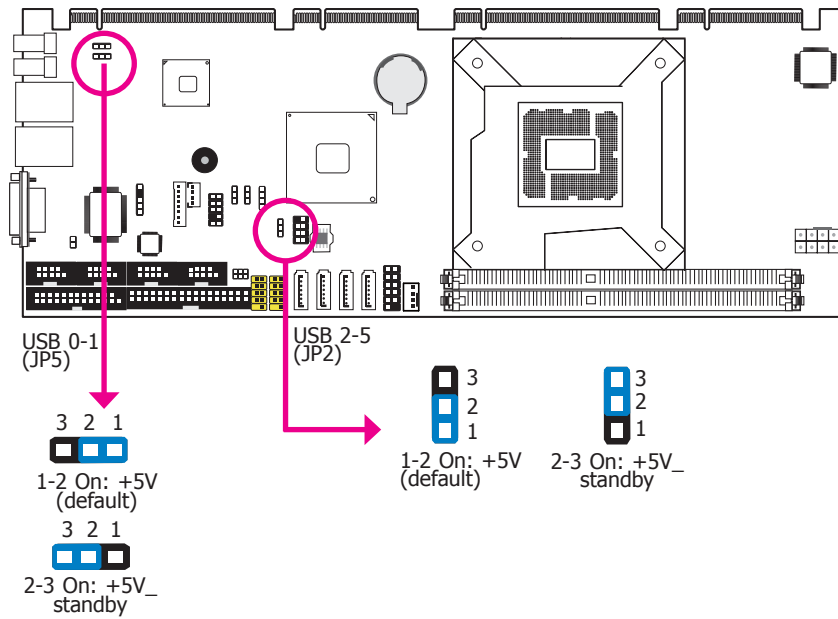

These jumpers are used to select the power of the USB ports. Selecting +5V\_standby will allow you to use a USB device to wake up the system.

**Important:**  
If you are using the Wake-On-USB Keyboard/Mouse function for 2 USB ports, the +5V\_standby power source of your power supply must support  $\geq 1.5A$ . For 3 or more USB ports, the +5V\_standby power source of your power supply must support  $\geq 2A$ .

### KB/MS Power Select

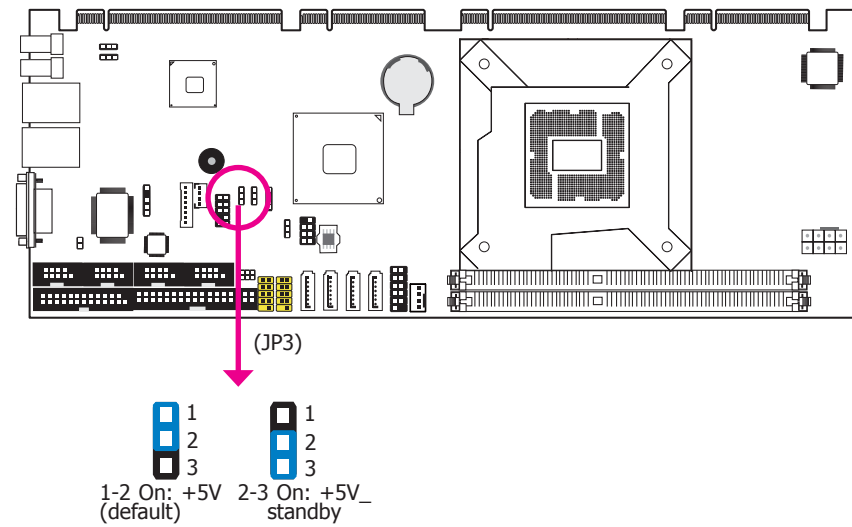

JP3 is used to select the power of the PS/2 keyboard and PS/2 mouse ports. Selecting +5V\_standby will allow you to use the PS/2 keyboard or PS/2 mouse to wake up the system.

**Important:**  
The +5VSB power source of your power supply must support  $\geq 720mA$ .

### Power-on Select

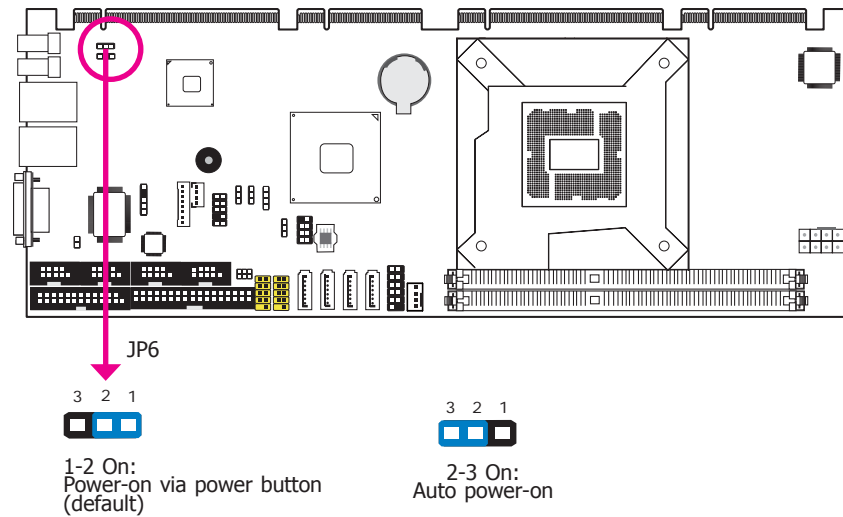

JP6 is used to select the method of powering on the system. If you want the system to power-on whenever AC power comes in, set JP6 pins 2 and 3 to On. If you want to use the power button, set pins 1 and 2 to On.

When using the JP6 “Power On” feature to power the system back on after a power failure occurs, the system may not power on if the power lost is resumed within 5 seconds (power flicker).

**Note:** In order to ensure that power is resumed after a power failure that recovers within a 5 second period, JP6 must be set to pins 2-3 and the “AC Power Lose” in CMOS is set to “On”.

### COM1 RS232/RS422/RS485 Select

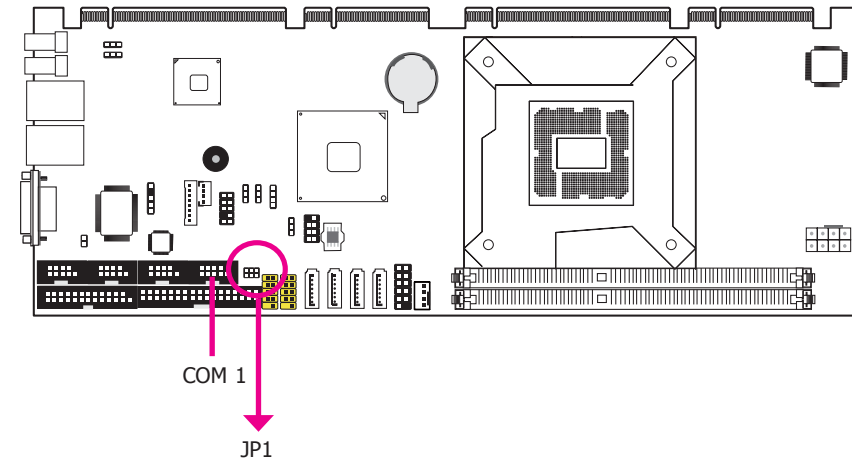

JP1 is used to configure the COM ports to RS232, RS422 (Full Duplex) or RS485. The pin function of the COM ports will vary according to the jumper’s setting.

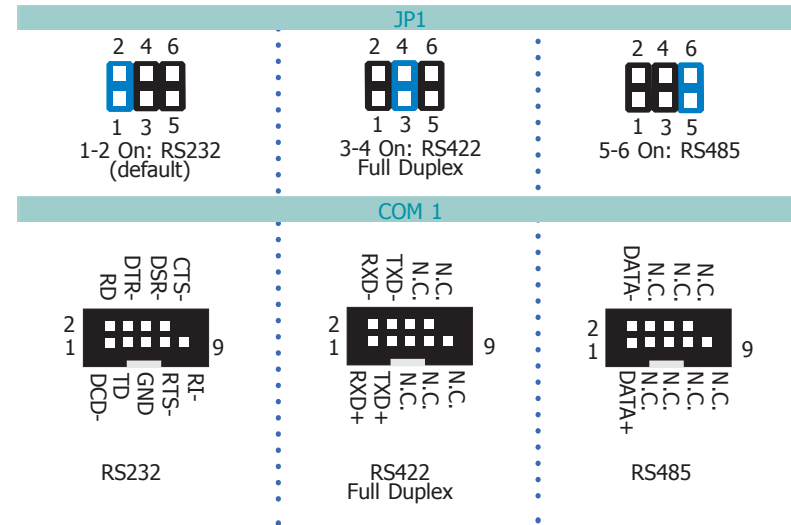



## Rear Panel I/O Ports



The rear panel I/O ports consist of the following:

- 2 USB ports
- 2 LAN ports
- VGA

## COM (Serial) Ports

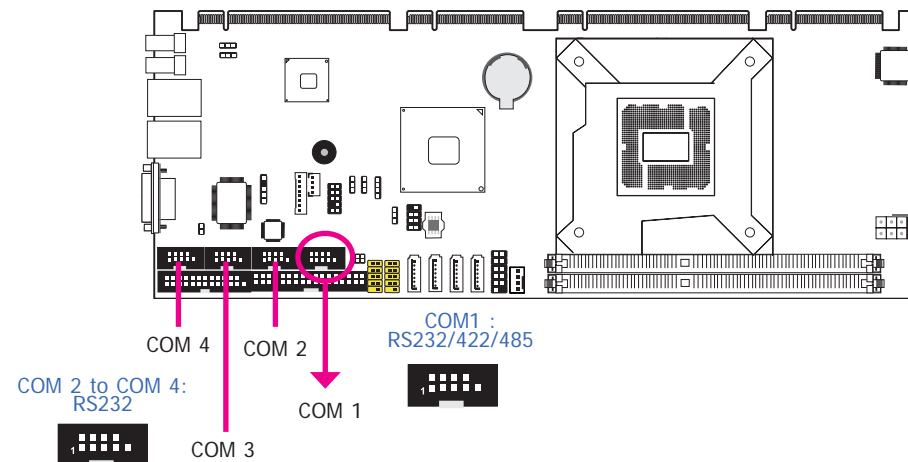

COM 2 to COM 4 are fixed at RS232.

The pin function of COM 1 ports will vary according to JP1's setting. Refer to "COM1 RS232/RS422/RS485 Select" in this chapter for more information.

The serial ports are asynchronous communication ports with 16C550A-compatible UARTs that can be used with modems, serial printers, remote display terminals, and other serial devices.

## Connecting External Serial Ports

Your COM port may come mounted on a card-edge bracket. Install the card-edge bracket to an available slot at the rear of the system chassis then insert the serial port cable to the COM connector. Make sure the colored stripe on the ribbon cable is aligned with pin 1 of the COM connector.

## BIOS Setting

Configure the serial ports in the Advanced menu ("Super IO Configuration" submenu) of the BIOS. Refer to chapter 3 for more information.

## USB Ports

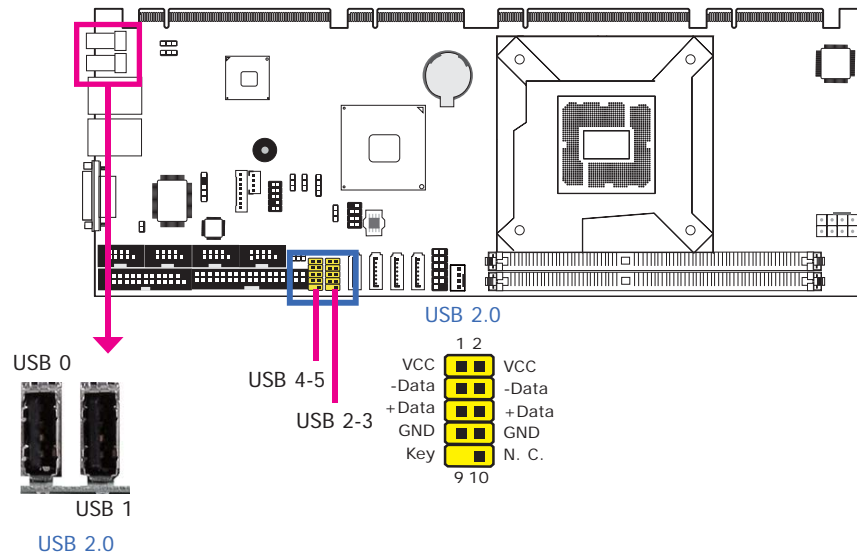

USB allows data exchange between your computer and a wide range of simultaneously accessible external Plug and Play peripherals.

The system board is equipped with two onboard USB 2.0/1.1 ports (USB 0-1). The two 10-pin connectors allow you to connect 4 additional USB 2.0/1.1 ports (USB 2-3/ USB 4-5). The additional USB ports may be mounted on a card-edge bracket. Install the card-edge bracket to an available slot at the rear of the system chassis and then insert the USB port cables to a connector.

## BIOS Setting

Configure the onboard USB in the Advanced menu ("USB Configuration" submenu) of the BIOS. Refer to chapter 3 for more information.

## RJ45 LAN Ports

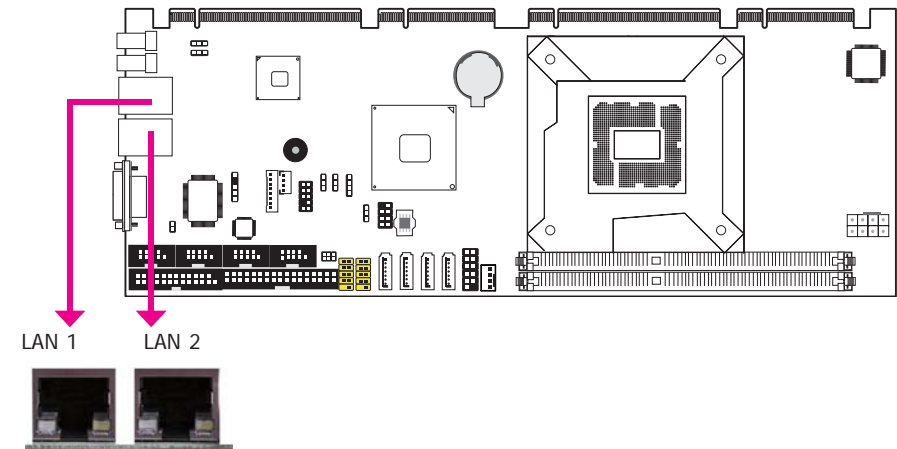

## Features

- 2 Intel® 82574 Gigabit Ethernet LAN controller

The LAN ports allow the system board to connect to a local area network by means of a network hub.

## BIOS Setting

Configure the onboard LAN in the Chipset menu ("South Bridge Configuration" submenu) of the BIOS. Refer to chapter 3 for more information.

## Driver Installation

Install the LAN drivers. Refer to chapter 4 for more information.

## VGA Port

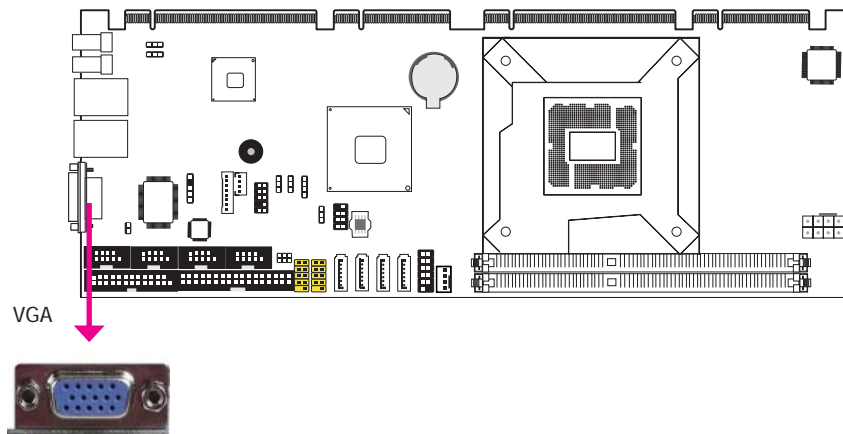

The VGA port is used for connecting a VGA monitor. Connect the monitor's 15-pin D-shell cable connector to the VGA port. After you plug the monitor's cable connector into the VGA port, gently tighten the cable screws to hold the connector in place.

## BIOS Setting

Configure VGA in the Chipset menu ("North Bridge Configuration" submenu) of the BIOS. Refer to chapter 3 for more information.

## Driver Installation

Install the graphics driver. Refer to chapter 4 for more information.

## I/O Connectors

### Digital I/O Connector

### Digital I/O Power Connector

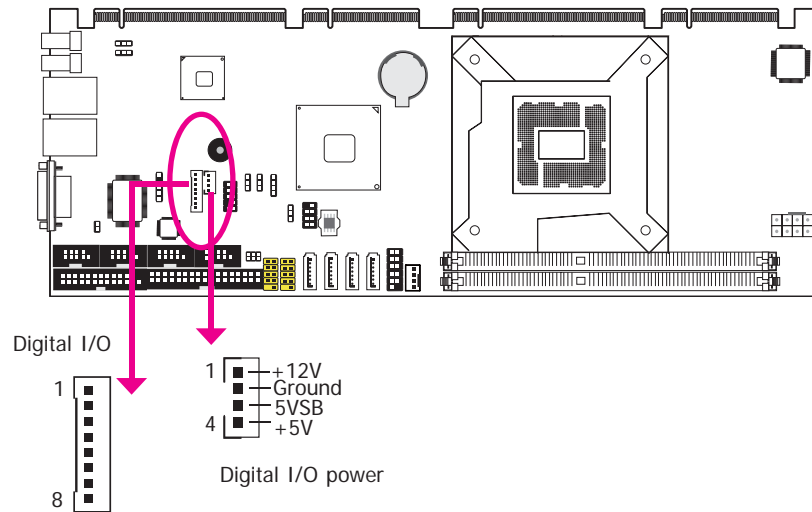

The 8-bit Digital I/O connector provides powering-on function to external devices that are connected to these connectors.

### Digital I/O Connector

Pins	Function
1	DIO7
2	DIO6
3	DIO5
4	DIO4
5	DIO3
6	DIO2
7	DIO1
8	DIO0

## SATA (Serial ATA) Connectors

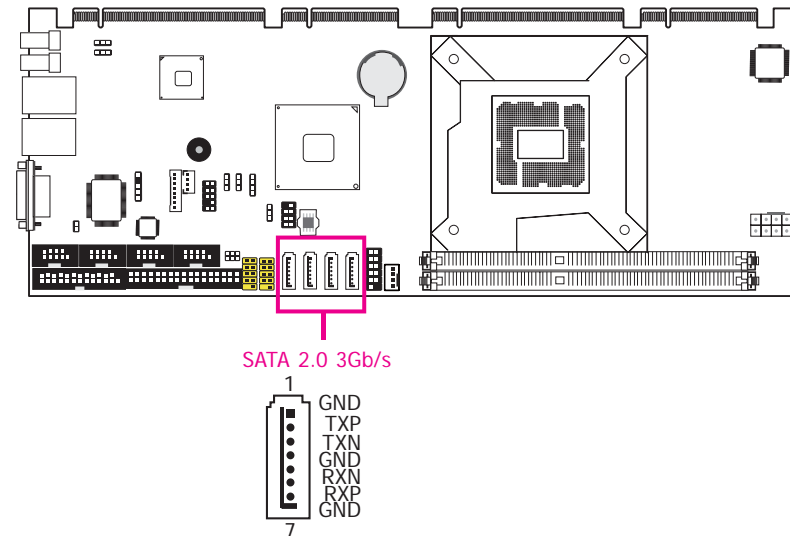

### Features

- SATA 0, SATA 1, SATA 4 and SATA 5 support data transfer rate up to 3Gb/s

The Serial ATA connectors are used to connect Serial ATA devices. Connect one end of the Serial ATA cable to a SATA connector and the other end to your Serial ATA device.

### BIOS Setting

Configure the Serial ATA drives in the Advanced menu ("SATA Configuration" submenu) of the BIOS. Refer to chapter 3 for more information.

## Cooling Fan Connectors

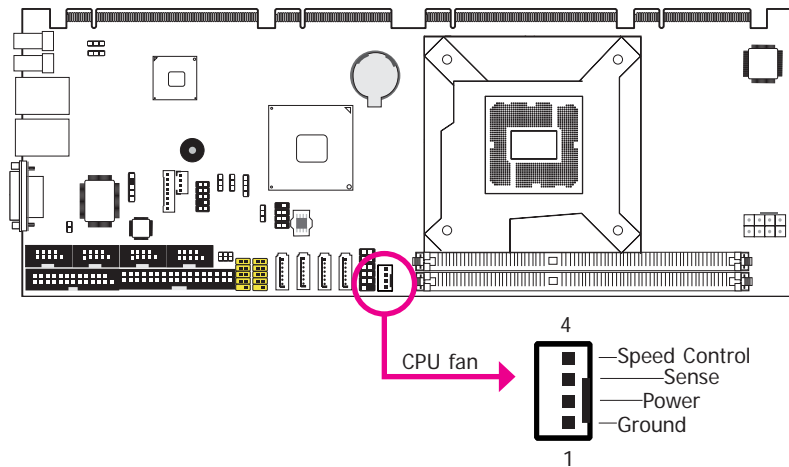

The fan connectors are used to connect cooling fans. The cooling fans will provide adequate airflow throughout the chassis to prevent overheating the CPU and system board components.

### BIOS Setting

The Advanced menu (“Hardware Health Configuration” submenu) of the BIOS will display the current speed of the cooling fans. Refer to chapter 3 for more information.

## Chassis Intrusion Connector

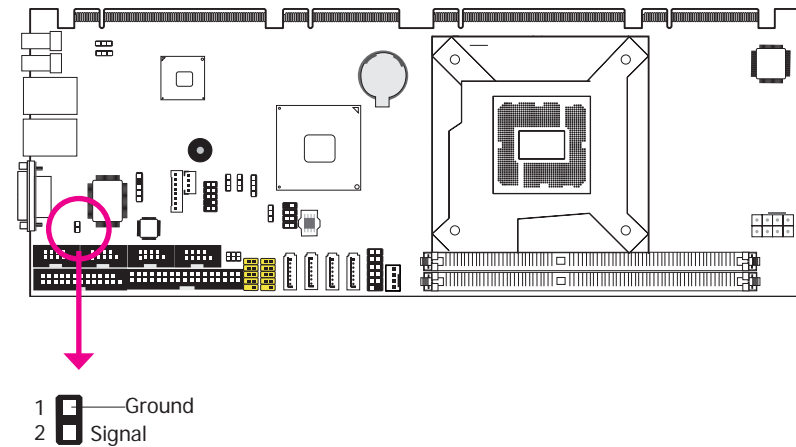

The board supports the chassis intrusion detection function. Connect the chassis intrusion sensor cable from the chassis to this connector. When the system’s power is on and a chassis intrusion occurred, an alarm will sound. When the system’s power is off and a chassis intrusion occurred, the alarm will sound only when the system restarts.

### MyGuard Hardware Monitor

Install the “MyGuard Hardware Monitor” utility. By default, the chassis intrusion detection function is disabled. When enabled, a warning message will appear when the chassis is open. The utility can also be configured so that a beeping alarm will sound when the chassis is open. Refer to the “MyGuard Hardware Monitor” section in chapter 4 for more information.

### Front Panel Connector

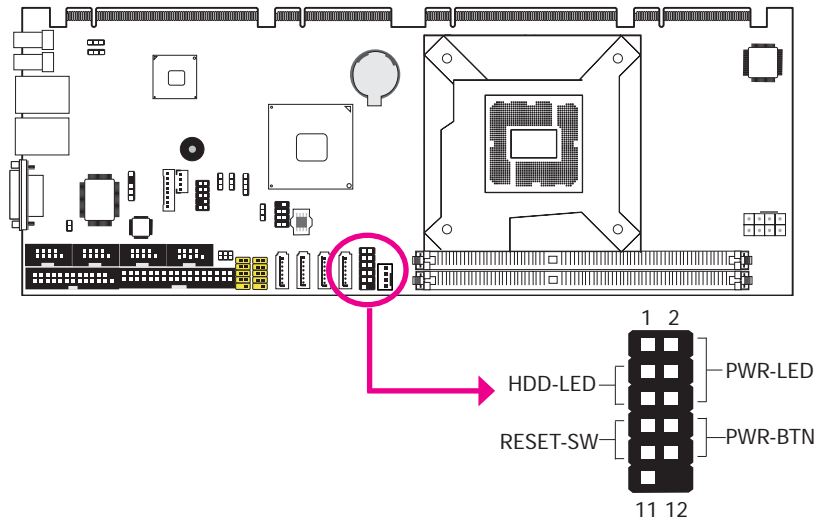

#### HDD-LED - HDD LED

This LED will light when the hard drive is being accessed.

#### RESET SW - Reset Switch

This switch allows you to reboot without having to power off the system.

#### PWR-BTN - Power Switch

This switch is used to power on or off the system.

#### PWR-LED - Power/Standby LED

When the system's power is on, this LED will light. When the system is in the S1 (POS - Power On Suspend) state, it will blink every second. When the system is in the S3 (STR - Suspend To RAM) state, it will blink every 4 seconds.

	Pin	Pin Assignment		Pin	Pin Assignment
HDD-LED	3	HDD Power	PWR-LED	2	LED Power
	5	Signal		4	LED Power
RESET SW	7	Ground	PWR-BTN	6	Signal
	9	RST Signal		8	Ground
	11	N.C.		10	Signal

### LPT Connector

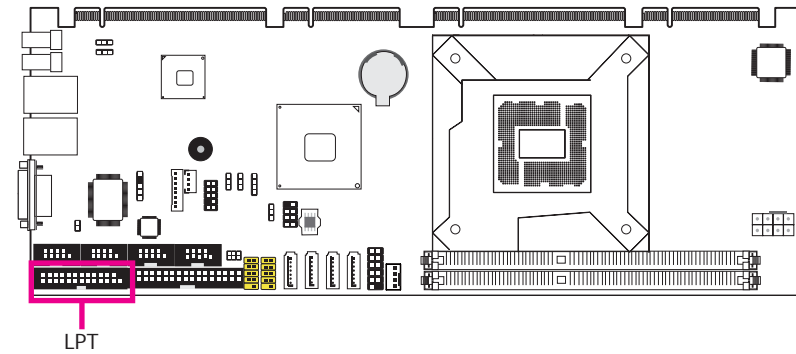

The LPT port is for interfacing your PC to a parallel printer. It supports SPP, ECP and EPP.

<b>SPP</b> (Standard Parallel Port)	Allows normal speed operation but in one direction only.
<b>ECP</b> (Extended Capabilities Port)	Allows parallel port to operate in bidirectional mode and at a speed faster than the SPP's data transfer rate.
<b>EPP</b> (Enhanced Parallel Port)	Allows bidirectional parallel port operation at maximum speed.

## FPD Connector

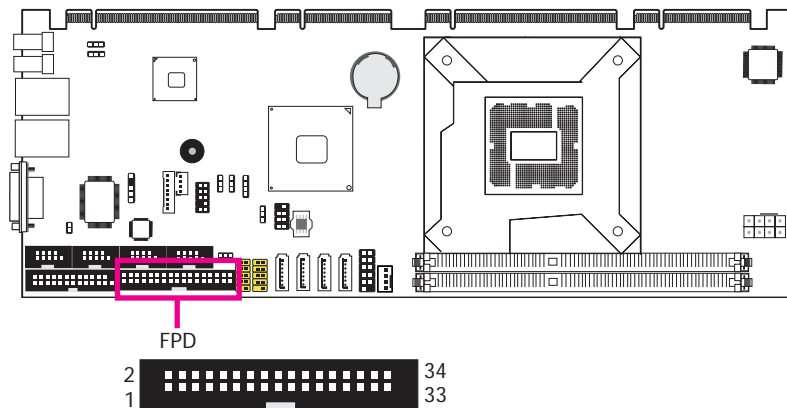

The FPD connector supports a standard floppy disk drive. The floppy cable can be inserted into this connector only if pin 1 of the cable is aligned with pin 1 of this connector.

### Connecting the FPD Cable

Insert one end of the FPD cable into the FPD connector and the other end of the cable to the floppy drive. Pin 1 of the cable must align with pin 1 of the FPD connector.

### BIOS Setting

Enable or disable this function in the Advanced menu ("Floppy Configuration" section) of the BIOS. Refer to chapter 3 for more information.

## KB/MS Connector

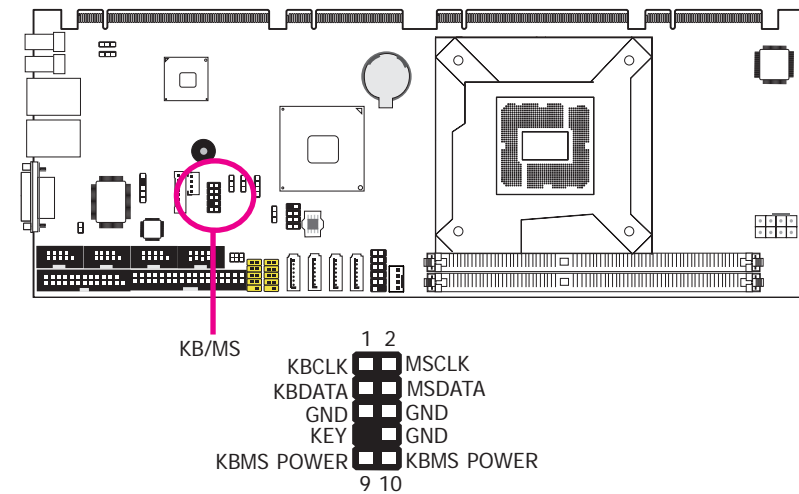

The KB/Mouse connector is used to connect PS/2 keyboard and PS/2 mouse by means of a PS/2 cable.

### Connecting the PS/2 Cable

The system board package comes with a PS/2 cable. Connect one end of the cable to the KB/Mouse connector. The other ends are used to connect a PS/2 keyboard and a PS/2 mouse.

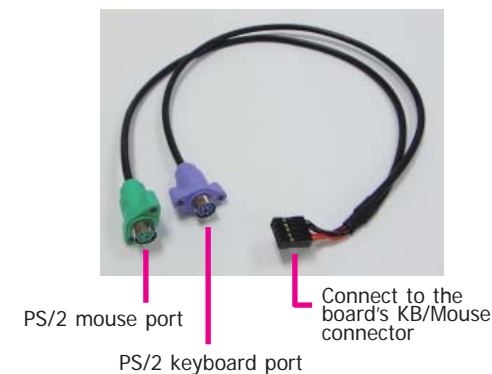

### Wake-On-PS/2 Keyboard/Mouse

The Wake-On-PS/2 Keyboard/Mouse function allows you to use the PS/2 keyboard or PS/2 mouse to power-on the system.

## IrDA Connector

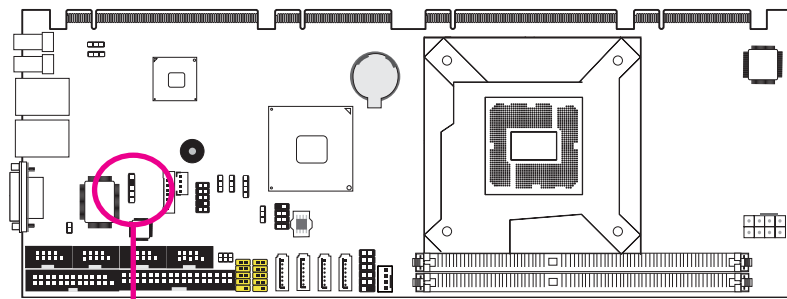

IrDA

1	— 5V
3	— IRRX
4	— IRTX
5	— IRTX

The system board is equipped with an IrDA connector for wireless connectivity between your computer and peripheral devices. The IRDA (Infrared Data Association) specification supports data transfers of 115K baud at a distance of 1 meter.

The IrDA connector is for connecting an IrDA module. Connect the cable from your IrDA module to IrDA connector.

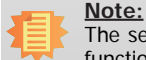

### Note:

The sequence of the pin functions on some IrDA cable may be reversed from the pin function defined on the system board. Make sure to connect the cable to the IrDA connector according to their pin functions.

## BIOS Setting

Set "UART2 Mode Select" ("Onboard Super IO Device" field) in the Integrated Peripherals sub-menu of the BIOS to the type of IrDA standard supported by your device.

## Driver Installation

You may need to install the proper drivers in your operating system to use the IrDA function. Refer to your operating system's manual or documentation for more information.

## SMBus

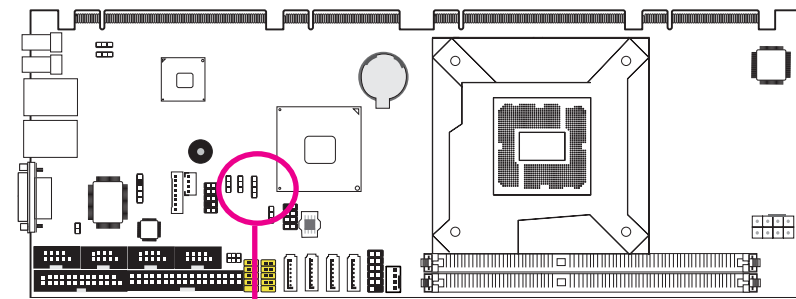

SMBus

3V3SB	— 1
SMB_DATA	— 2
SMB_CLK	— 3
Ground	— 4

The SMBus (System Management Bus) connector is used to connect SMBus devices. It is a multiple device bus that allows multiple chips to connect to the same bus and enable each one to act as a master by initiating data transfer.



## Power Connectors

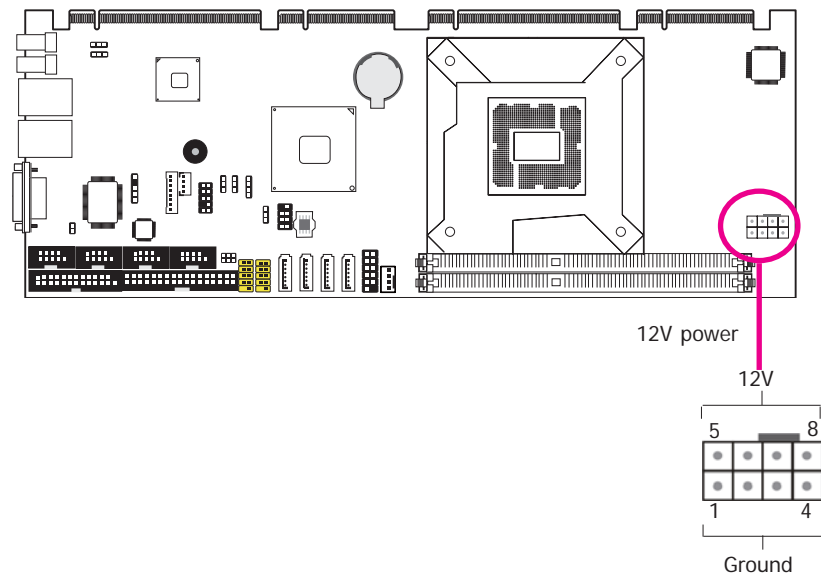

Use a power supply that complies with the ATX12V Power Supply Design Guide Version 1.1. An ATX12V power supply unit has a standard 20-pin ATX main power connector that must be inserted into the 20-pin connector. The 4-pin +12V power connector enables the delivery of more +12VDC current to the processor's Voltage Regulator Module (VRM).

The power connectors from the power supply unit are designed to fit the 20-pin and 4-pin connectors in only one orientation. Make sure to find the proper orientation before plugging the connectors.

The system board requires a minimum of 300 Watt power supply to operate. Your system configuration (CPU power, amount of memory, add-in cards, peripherals, etc.) may exceed the minimum power requirement. To ensure that adequate power is provided, we strongly recommend that you use a minimum of 400 Watt (or greater) power supply.



### Important:

Insufficient power supplied to the system may result in instability or the add-in boards and peripherals not functioning properly. Calculating the system's approximate power usage is important to ensure that the power supply meets the system's consumption requirements.

## Battery

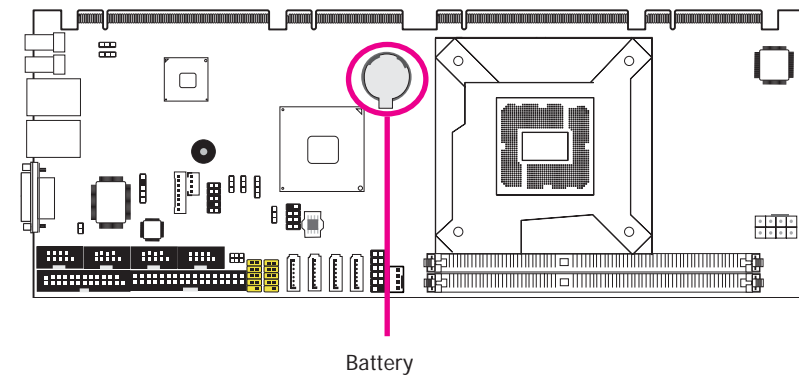

The lithium ion battery powers the real-time clock and CMOS memory. It is an auxiliary source of power when the main power is shut off.

### Safety Measures

- Danger of explosion if battery incorrectly replaced.
- Replace only with the same or equivalent type recommend by the manufacturer.
- Dispose of used batteries according to local ordinance.

## Chapter 3 - BIOS Setup

### Overview

The BIOS is a program that takes care of the basic level of communication between the CPU and peripherals. It contains codes for various advanced features found in this system board. The BIOS allows you to configure the system and save the configuration in a battery-backed CMOS so that the data retains even when the power is off. In general, the information stored in the CMOS RAM of the EEPROM will stay unchanged unless a configuration change has been made such as a hard drive replaced or a device added.

It is possible that the CMOS battery will fail causing CMOS data loss. If this happens, you need to install a new CMOS battery and reconfigure the BIOS settings.



**Note:**

The BIOS is constantly updated to improve the performance of the system board; therefore the BIOS screens in this chapter may not appear the same as the actual one. These screens are for reference purpose only.

### Default Configuration

Most of the configuration settings are either predefined according to the Load Optimal Defaults settings which are stored in the BIOS or are automatically detected and configured without requiring any actions. There are a few settings that you may need to change depending on your system configuration.

### Entering the BIOS Setup Utility

The BIOS Setup Utility can only be operated from the keyboard and all commands are keyboard commands. The commands are available at the right side of each setup screen.

The BIOS Setup Utility does not require an operating system to run. After you power up the system, the BIOS message appears on the screen and the memory count begins. After the memory test, the message "Press DEL to run setup" will appear on the screen. If the message disappears before you respond, restart the system or press the "Reset" button. You may also restart the system by pressing the <Ctrl> <Alt> and <Del> keys simultaneously.

### Legends

Keys	Function
Right and Left arrows	Moves the highlight left or right to select a menu.
Up and Down arrows	Moves the highlight up or down between submenu or fields.
<Esc>	Exit to the BIOS Setup Utility.
+ (plus key)	Scrolls forward through the values or options of the highlighted field.
- (minus key)	Scrolls backward through the values or options of the highlighted field.
Tab	Select a field.
<F1>	Displays General Help
<F4>	Saves and exits the Setup program.
<Enter>	Press <Enter> to enter the highlighted submenu.

### Scroll Bar

When a scroll bar appears to the right of the setup screen, it indicates that there are more available fields not shown on the screen. Use the up and down arrow keys to scroll through all the available fields.

### Submenu

When "►" appears on the left of a particular field, it indicates that a submenu which contains additional options are available for that field. To display the submenu, move the highlight to that field and press <Enter>.

## AMI BIOS Setup Utility

### Main

The Main menu is the first screen that you will see when you enter the BIOS Setup Utility.

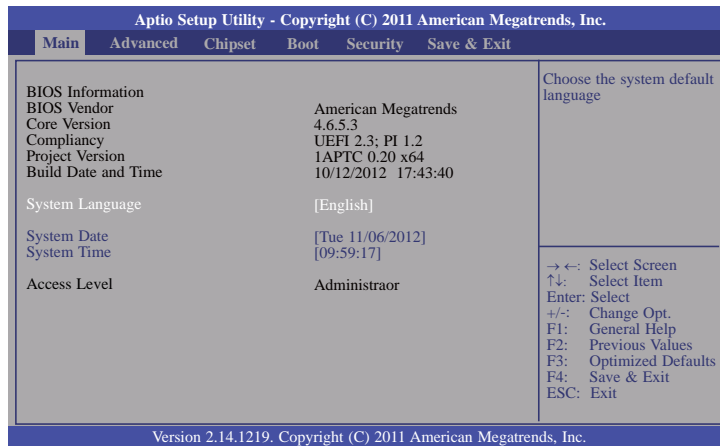

#### System Date

The date format is <day>, <month>, <date>, <year>. Day displays a day, from Sunday to Saturday. Month displays the month, from January to December. Date displays the date, from 1 to 31. Year displays the year, from 1980 to 2099.

#### System Time

The time format is <hour>, <minute>, <second>. The time is based on the 24-hour military-time clock. For example, 1 p.m. is 13:00:00. Hour displays hours from 00 to 23. Minute displays minutes from 00 to 59. Second displays seconds from 00 to 59.

### Advanced

The Advanced menu allows you to configure your system for basic operation. Some entries are defaults required by the system board, while others, if enabled, will improve the performance of your system or let you set some features according to your preference.



#### Important:

Setting incorrect field values may cause the system to malfunction.

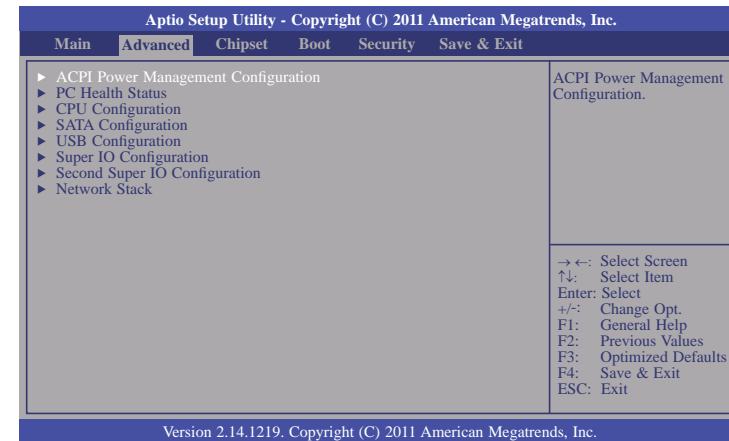

## ACPI Power Management Configuration

This section is used to configure the ACPI Setting.

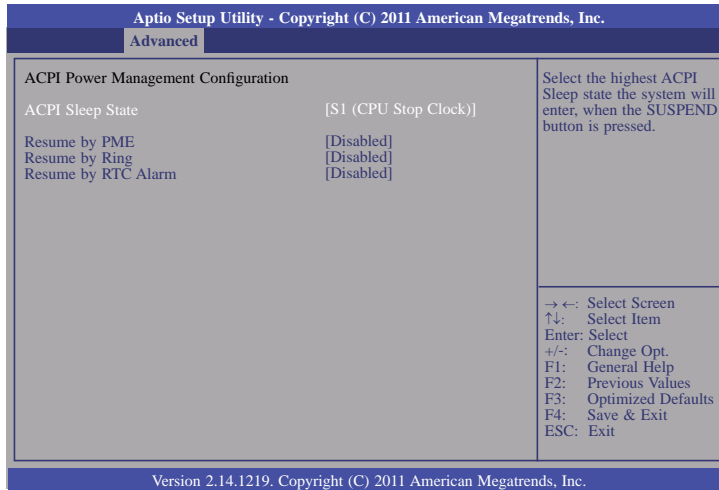

### ACPI Sleep State

Selects the highest ACPI sleep state the system will enter when the Suspend button is pressed.

S1(POS) Enables the Power On Suspend function.

S3(STR) Enables the Suspend to RAM function.

### Resume by PME

Enable this field to use the PME signal to wake up the system.

### Resume by Ring

Enable this field to use the Ring signal to wake up the system.

### Resume by RTC Alarm

When Enabled, the system uses the RTC to generate a wakeup event.

## PC Health Status

This section displays the SIO hardware health monitor.

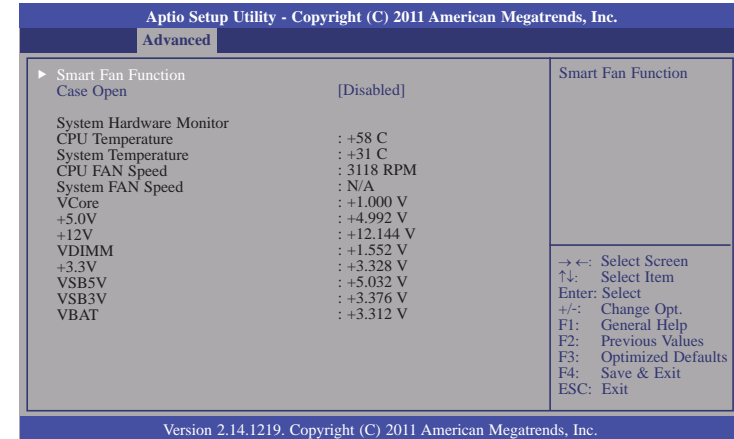

### Smart Fan Function

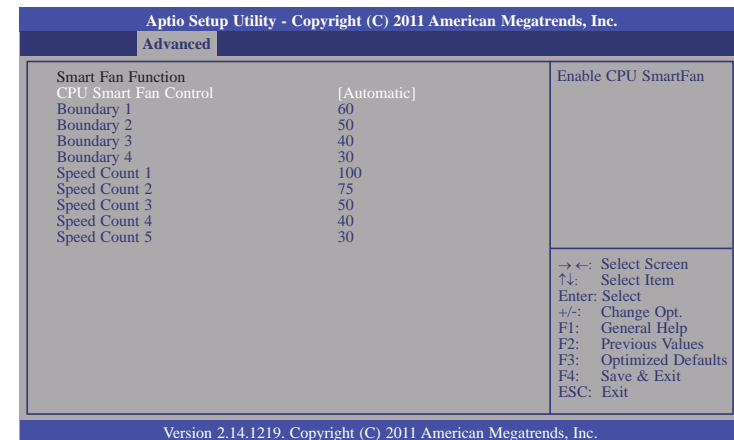

### CPU Smart Fan Control

When this feature is set to Automatic, the CPU's fan speed will rotate according to the CPU's temperature. The higher the temperature, the faster the speed of rotation.

## CPU Configuration

This section is used to configure the CPU. It will also display the detected CPU information.

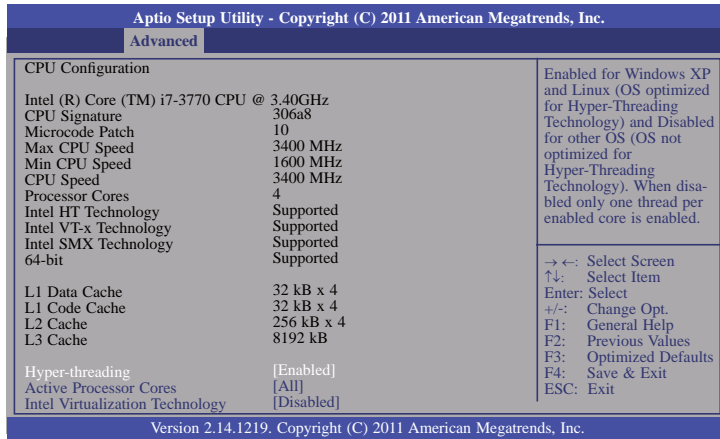

### Hyper-threading

Enable this field for Windows XP and Linux which are optimized for Hyper-Threading technology. Select disabled for other OSes not optimized for Hyper-Threading technology. When disabled, only one thread per enabled core is enabled.

### Active Processor Cores

Number of cores to enable in each processor package.

### Intel Virtualization Technology

When this field is set to Enabled, the VMM can utilize the additional hardware capabilities provided by Vanderpool Technology.

## SATA Configuration

This section is used to configure SATA functions.

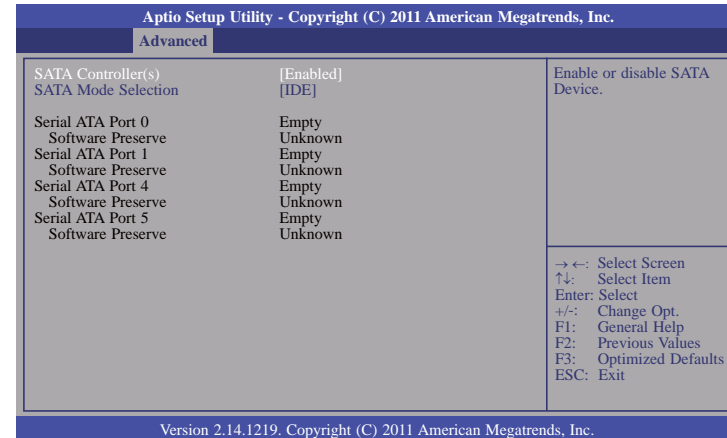

### SATA Controller(s)

This field is used to enable or disable the Serial ATA channels.

### SATA Mode Selection

IDE Mode

This option configures the Serial ATA drives as Parallel ATA storage devices.

## USB Configuration

This section is used to configure USB.

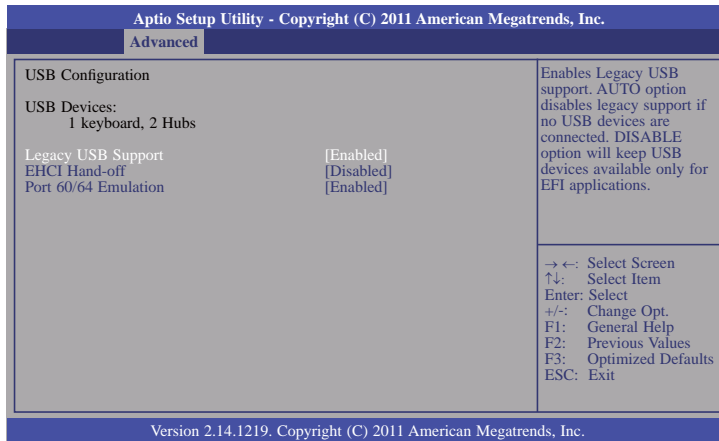

### Legacy USB Support

Enabled

Enables legacy USB.

Auto

Disables support for legacy when no USB devices are connected.

Disabled

Keeps USB devices available only for EFI applications.

### EHCI Hand-off

This is a workaround for OSes that does not support EHCI hand-off. The EHCI ownership change should be claimed by the EHCI driver.

### Port 60/64 Emulation

Enables I/O port 60h/64h emulation support. This should be enabled for the complete USB keyboard legacy support for non-USB aware OSes.

## Super IO Configuration

This section is used to configure the I/O functions supported by the onboard Super I/O chip.

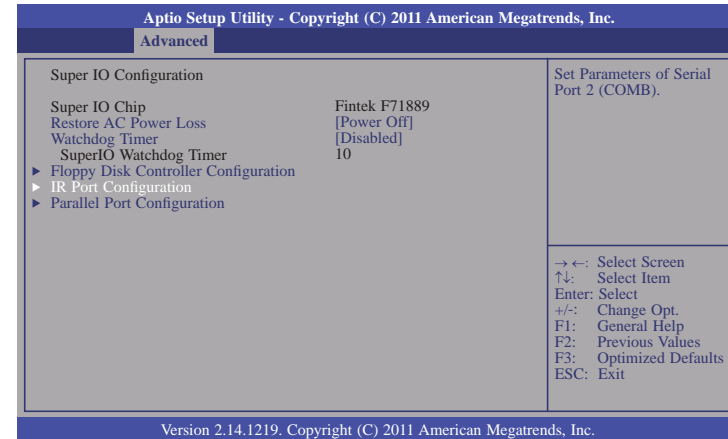

### Restore AC Power Loss

Off

When power returns after an AC power failure, the system's power is off. You must press the Power button to power-on the system.

On

When power returns after an AC power failure, the system will automatically power-on.

Last State

When power returns after an AC power failure, the system will return to the state where you left off before power failure occurs. If the system's power is off when AC power failure occurs, it will remain off when power returns. If the system's power is on when AC power failure occurs, the system will power-on when power returns.

### Watchdog Timer

Enable or disable Super I/O watchdog timer.

## Floppy Disk Controller Configuration

Aptio Setup Utility - Copyright (C) 2011 American Megatrends, Inc.		
Advanced		
Floppy Disk Controller Configuration		Enable or Disable Floppy Disk Controller
Floppy Disk Controller Device Settings	[Enabled] IO=3F0h; IRQ=6; DMA=2	
Change Settings	[Auto]	
		→ ←: Select Screen ↑ ↓: Select Item Enter: Select +/-: Change Opt. F1: General Help F2: Previous Values F3: Optimized Defaults F4: Save & Exit ESC: Exit
Version 2.14.1219. Copyright (C) 2011 American Megatrends, Inc.		

### Change Settings

Select an optimal setting for Super IO device.

## IR Port Configuration

Aptio Setup Utility - Copyright (C) 2011 American Megatrends, Inc.		
Advanced		
IR Port Configuration		Enable or Disable Serial Port (COM).
Serial Port	[Disabled]	
		→ ←: Select Screen ↑ ↓: Select Item Enter: Select +/-: Change Opt. F1: General Help F2: Previous Values F3: Optimized Defaults F4: Save & Exit ESC: Exit
Version 2.14.1219. Copyright (C) 2011 American Megatrends, Inc.		

## IR Port Configuration

Aptio Setup Utility - Copyright (C) 2011 American Megatrends, Inc.		
Advanced		
IR Port Configuration		Enable or Disable Serial Port (COM).
Serial Port Device Settings	[Enabled] IO=2F8h; IRQ=3	
Change Settings	[Auto]	
		→ ←: Select Screen ↑ ↓: Select Item Enter: Select +/-: Change Opt. F1: General Help F2: Previous Values F3: Optimized Defaults F4: Save & Exit ESC: Exit
Version 2.14.1219. Copyright (C) 2011 American Megatrends, Inc.		

### Change Settings

Select an optimal setting for Super IO device.

## Parallel Port Configuration

Aptio Setup Utility - Copyright (C) 2011 American Megatrends, Inc.		
Advanced		
Parallel Port Configuration		Enable or Disable Parallel Port (LPT/LPTE)
Serial Port Device Settings	[Enabled] IO=378h; IRQ=7;	
Change Settings Device Mode	[Auto] [STD Printer Mode]	
		→ ←: Select Screen ↑ ↓: Select Item Enter: Select +/-: Change Opt. F1: General Help F2: Previous Values F3: Optimized Defaults F4: Save & Exit ESC: Exit
Version 2.14.1219. Copyright (C) 2011 American Megatrends, Inc.		

### Serial Port

Enables or disables the serial port.

### Change Settings

Selects the IO/IRQ setting of the I/O device.

### Device Mode

Enable or disable serial port (LPT/LPTE)



## Second Super IO Configuration

This section is used to configure the I/O functions supported by the onboard Super I/O chip.

Aptio Setup Utility - Copyright (C) 2011 American Megatrends, Inc.	
Advanced	
Second Super IO Configuration Super IO Chip: Fintek-F81217 ▶ Serial Port 1 Configuration ▶ Serial Port 2 Configuration ▶ Serial Port 3 Configuration ▶ Serial Port 4 Configuration	Set parameters of Serial Port 1(COMC).  → ←: Select Screen ↑↓: Select Item Enter: Select +/-: Change Opt. F1: General Help F2: Previous Values F3: Optimized Defaults ESC: Exit
Version 2.14.1219. Copyright (C) 2011 American Megatrends, Inc.	

## Serial Port 1 Configuration to Serial Port 4 Configuration

Aptio Setup Utility - Copyright (C) 2011 American Megatrends, Inc.	
Advanced	
Serial Port 1 Configuration Serial Port: [Enabled] Device Settings: IO=3E8h; IRQ=5; Change Settings: [Auto]	Enable or Disable Serial Port (COM)  → ←: Select Screen ↑↓: Select Item Enter: Select +/-: Change Opt. F1: General Help F2: Previous Values F3: Optimized Defaults ESC: Exit
Version 2.14.1219. Copyright (C) 2011 American Megatrends, Inc.	

Aptio Setup Utility - Copyright (C) 2011 American Megatrends, Inc.	
Advanced	
Serial Port 2 Configuration Serial Port: [Enabled] Device Settings: IO=2E8h; IRQ=5; Change Settings: [Auto]	Enable or Disable Serial Port (COM)  → ←: Select Screen ↑↓: Select Item Enter: Select +/-: Change Opt. F1: General Help F2: Previous Values F3: Optimized Defaults ESC: Exit
Version 2.14.1219. Copyright (C) 2011 American Megatrends, Inc.	

Aptio Setup Utility - Copyright (C) 2011 American Megatrends, Inc.	
Advanced	
Serial Port 3 Configuration Serial Port: [Enabled] Device Settings: IO=3E0h; IRQ=10; Change Settings: [Auto]	Enable or Disable Serial Port (COM)  → ←: Select Screen ↑↓: Select Item Enter: Select +/-: Change Opt. F1: General Help F2: Previous Values F3: Optimized Defaults ESC: Exit
Version 2.14.1219. Copyright (C) 2011 American Megatrends, Inc.	

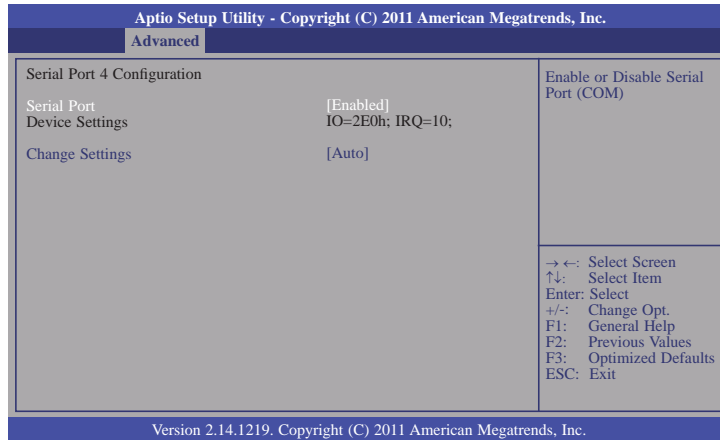

### Serial Port

Enables or disables the serial port.

### Change Settings

Selects the IO/IRQ setting of the I/O device.

### Network Stack

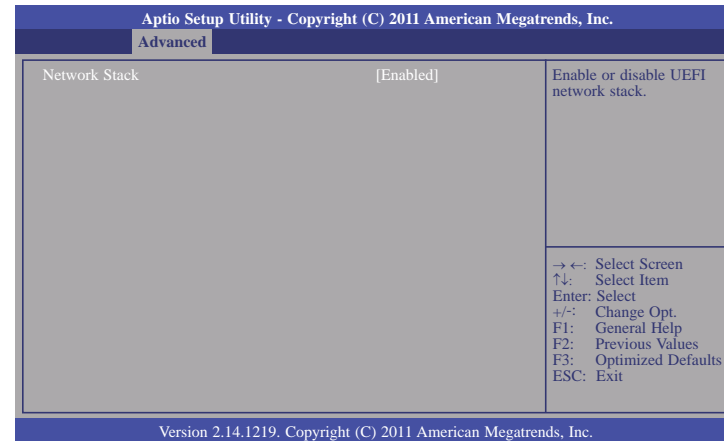

## Chipset

Configures relevant chipset functions.

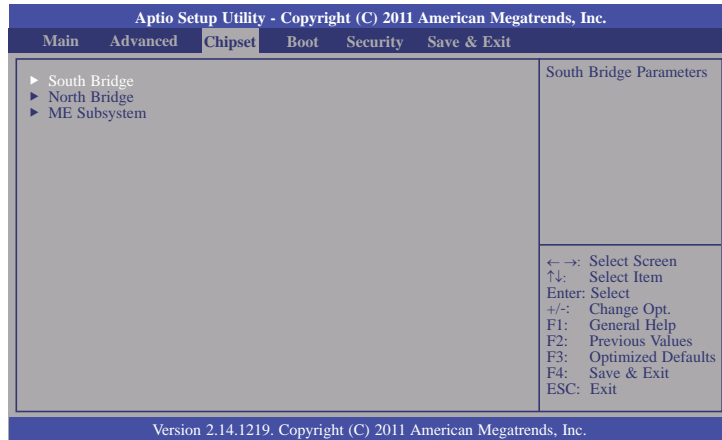

## South Bridge

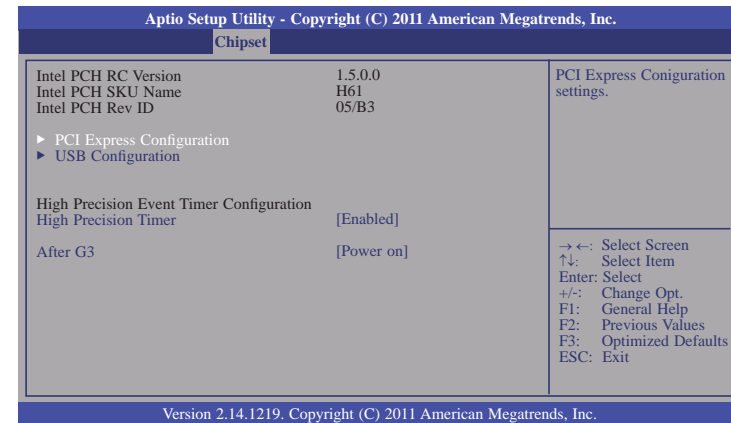

### High Precision Timer

Enable or disable the High Precision Timer.

### After G3

Power Off / WOL

Power-on the system via WOL after G3.

Power On

Power-on the system after G3.

## PCI Express Configuration

Aptio Setup Utility - Copyright (C) 2011 American Megatrends, Inc.		
Chipset		
PCI Express Configuration		Enable or disable LAN.
PCI Express Root Port	[Enabled]	
Onboard 82574 LAN Controller	[Enabled]	
		→ ←: Select Screen ↑↓: Select Item Enter: Select +/-: Change Opt. F1: General Help F2: Previous Values F3: Optimized Defaults ESC: Exit
Version 2.14.1219. Copyright (C) 2011 American Megatrends, Inc.		

## USB Configuration

Aptio Setup Utility - Copyright (C) 2011 American Megatrends, Inc.		
Chipset		
USB Configuration		Control the USB EHCI (USB 2.0) functions. One EHCI controller must always be enabled.
EHCI1	[Enabled]	
EHCI2	[Enabled]	
USB Ports Per-Port Disable Controller	[Disabled]	
		→ ←: Select Screen ↑↓: Select Item Enter: Select +/-: Change Opt. F1: General Help F2: Previous Values F3: Optimized Defaults ESC: Exit
Version 2.14.1219. Copyright (C) 2011 American Megatrends, Inc.		

### EHCI1 and EHCI2

These fields are used to enable or disable USB 2.0.

### USB Ports Per-Port Disable Controller

Control each of the USB ports (0-13) disabling.

## North Bridge

Aptio Setup Utility - Copyright (C) 2011 American Megatrends, Inc.		
Chipset		
System Agent Bridge Name	Ivy Bridge	Check to enable VT-d function on MCH.
System Agent RC Version	1.5.0.0	
VT-d Capability	Supported	
VT-d	[Enabled]	
C-State Pre-Wake	[Enabled]	
<ul style="list-style-type: none"> <li>▶ Graphics Configuration</li> <li>▶ NB PCIe Configuration</li> <li>▶ Memory Configuration</li> </ul>		
		→ ←: Select Screen ↑↓: Select Item Enter: Select +/-: Change Opt. F1: General Help F2: Previous Values F3: Optimized Defaults ESC: Exit
Version 2.14.1219. Copyright (C) 2011 American Megatrends, Inc.		

## C-State Pre-Wake

Controls C-State Pre-Wake feature for ARAT, in SSKPD[57].

## Graphics Configuration

Aptio Setup Utility - Copyright (C) 2011 American Megatrends, Inc.		
Chipset		
Graphics Configuration		
IGFX VBIOS Version	2137	Select which of IGFX/PEG/PCI Graphics device should be primary delay or select SG for switchable Gfx.
IGfx Frequency	350 MHz	
Primary Display	[Auto]	
Internal Graphics	[Auto]	
DVMT Pre-Allocated	[64M]	
DVMT Total Gfx Mem	[256M]	
▶ LCD Control		
		→ ←: Select Screen ↑↓: Select Item Enter: Select +/-: Change Opt. F1: General Help F2: Previous Values F3: Optimized Defaults ESC: Exit
Version 2.14.1219. Copyright (C) 2011 American Megatrends, Inc.		

## Primary Display

Select which of IGFX/PEG/PCI Graphics device should be primary display or select SG for switchable Gfx.

## Internal Graphics

Keep IGD enabled based on the setup options.

## DVMT Pre-Allocated

Select DVMT 5.0 Pre-Allocated (Fixed) Graphics Memory size used by the Internal Graphics Device.

## DVMT Total Gfx Mem

Select DVMT5.0 total graphics memory size used by the internal graphics device.

## LCD Control

Aptio Setup Utility - Copyright (C) 2011 American Megatrends, Inc.		
Chipset		
LCD Control		Select the Video Device which will be activated during POST. This has no effect if external graphics present. Secondary boot display selection will appear based on your selection. VGA modes will be supported only on primary display. → ←: Select Screen ↑↓: Select Item Enter: Select +/-: Change Opt. F1: General Help F2: Previous Values F3: Optimized Defaults ESC: Exit
Primary IGFX Boot Display	[VBIOS Default]	
SDVO-LFP Panel Type	[VBIOS Default]	
Version 2.14.1219. Copyright (C) 2011 American Megatrends, Inc.		

## Memory Information

Aptio Setup Utility - Copyright (C) 2011 American Megatrends, Inc.		
Chipset		
Memory Information		→ ←: Select Screen ↑↓: Select Item Enter: Select +/-: Change Opt. F1: General Help F2: Previous Values F3: Optimized Defaults ESC: Exit
Memory RC Version	1.5.0.0	
Memory Frequency	1333 Mhz	
Total Memory	4096 MB (DDR3)	
DIMM#1	2048 MB (DDR3)	
DIMM#2	2048 MB (DDR3)	
CAS Latency (tCL)	9	
Minimum delay time		
CAS to RAS (tRCDmin)	9	
Row Precharge (tRPmin)	9	
Active to Precharge (tRASmin)	24	
XMP Profile 1	Not support	
XMP Profile 2	Not support	
Version 2.14.1219. Copyright (C) 2011 American Megatrends, Inc.		

## NB PCIe Configuration

Aptio Setup Utility - Copyright (C) 2011 American Megatrends, Inc.		
Chipset		
NB PCIe Configuration		Configure PEG B0:D1:F0 Gen1-Gen3. → ←: Select Screen ↑↓: Select Item Enter: Select +/-: Change Opt. F1: General Help F2: Previous Values F3: Optimized Defaults ESC: Exit
PEG	Not Present [Gen1]	
Enable PEG	[Enabled]	
Version 2.14.1219. Copyright (C) 2011 American Megatrends, Inc.		

### Enabled PEG

To enable or disable the PEG.

## ME Subsystem

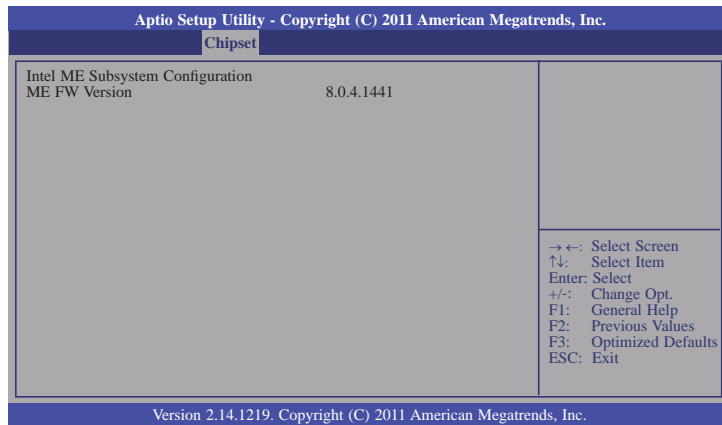

## Boot

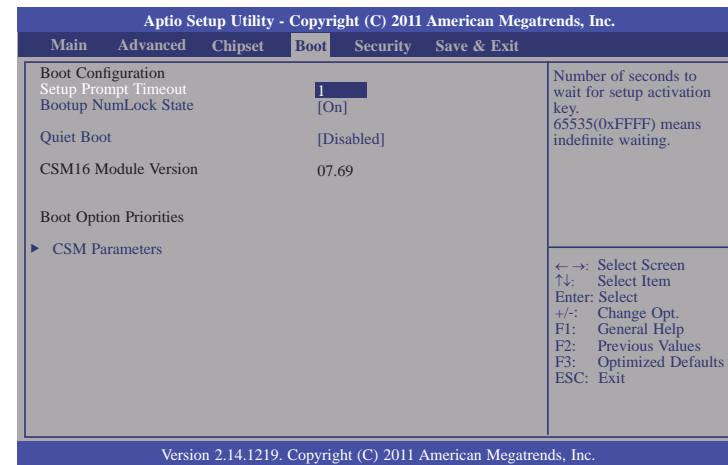

## Setup Prompt Timeout

Selects the number of seconds to wait for the setup activation key. 65535(0xFFFF) denotes indefinite waiting.

## Bootup NumLock State

This allows you to determine the default state of the numeric keypad. By default, the system boots up with NumLock on wherein the function of the numeric keypad is the number keys. When set to Off, the function of the numeric keypad is the arrow keys.

## Quiet Boot

Enables or disables the quiet boot function.

## CSM Parameters

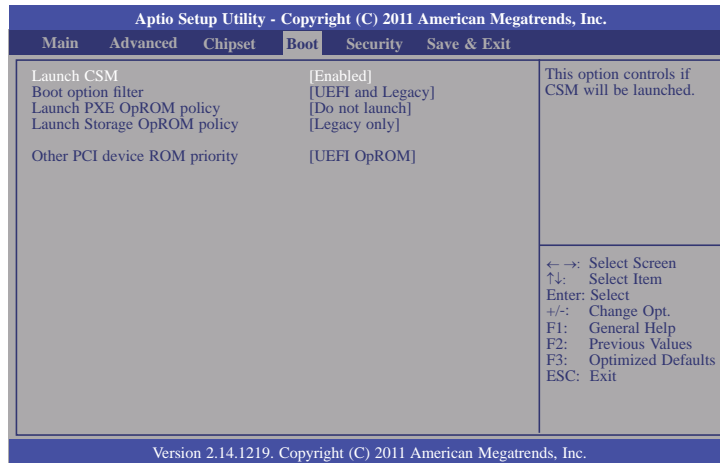

### Boot option filter

This option controls what devices system can be boot to.

### Launch PXE OpROM policy

Controls the execution of UEFI and legacy PXE OpROM.

### Launch Storage OpROM policy

Controls the execution of UEFI and legacy storage OpROM.

### Other PCI device ROM priority

For PCI devices other than Network, Mass Storage, or Video defines which OpROM to launch.

## Security

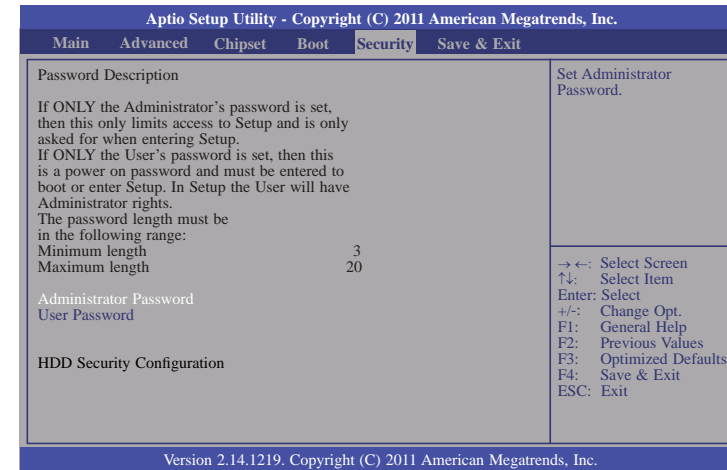

### Administrator Password

Sets the administrator password.

### User Password

Sets the user password.



## Save & Exit

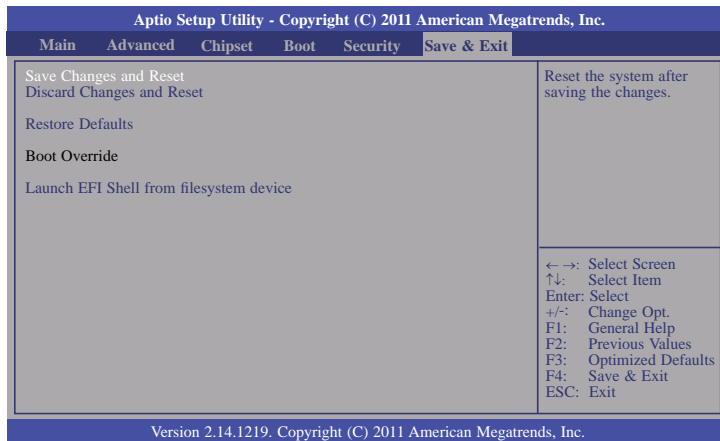

### Save Changes and Reset

To save the changes, select this field and then press <Enter>. A dialog box will appear. Select Yes to reset the system after saving all changes made.

### Discard Changes and Reset

To discard the changes, select this field and then press <Enter>. A dialog box will appear. Select Yes to reset the system setup without saving any changes.

### Restore Defaults

To restore and load the optimized default values, select this field and then press <Enter>. A dialog box will appear. Select Yes to restore the default values of all the setup options.

### Launch EFI Shell from filesystem device

Attempts to Launch EFI Shell application (Shellx64.efi) from one of the available filesystem devices.

## Updating the BIOS

To update the BIOS, you will need the new BIOS file and a flash utility, AFUDOS.EXE. Please contact technical support or your sales representative for the files.

To execute the utility, type:

```
A:> AFUDOS BIOS_File_Name /b /p /n
```

then press <Enter>.

```
C:\AFU\AFUDOS>afudos filename /B /P /N
-----+-----
                AMI Firmware Update Utility(APTIO) v2.25
                Copyright (C)2008 American Megatrends Inc. All Rights Reserved.
-----+-----
Reading file ..... done
Erasing flash ..... done
Writing flash ..... done
Verifying flash ..... done
Erasing BootBlock ..... done
Writing BootBlock ..... done
Verifying BootBlock ..... done

C:\AFU\AFUDOS>
```

After finishing BIOS update, please turn off the AC power. Wait about 10 seconds and then turn on the AC power again.

## Chapter 4 - Supported Software

The CD that came with the system board contains drivers, utilities and software applications required to enhance the performance of the system board.

Insert the CD into a CD-ROM drive. The autorun screen (Mainboard Utility CD) will appear. If after inserting the CD, "Autorun" did not automatically start (which is, the Mainboard Utility CD screen did not appear), please go directly to the root directory of the CD and double-click "Setup".

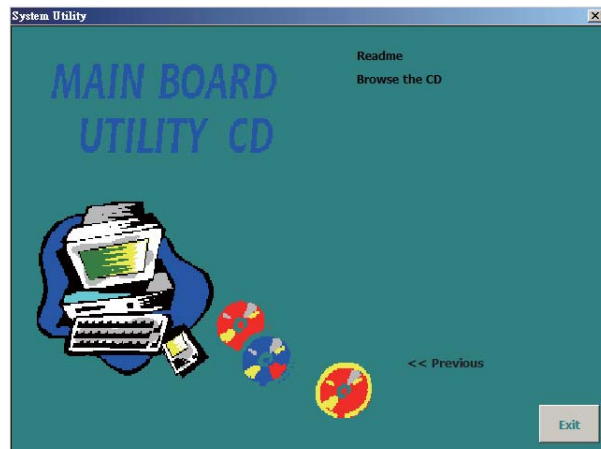
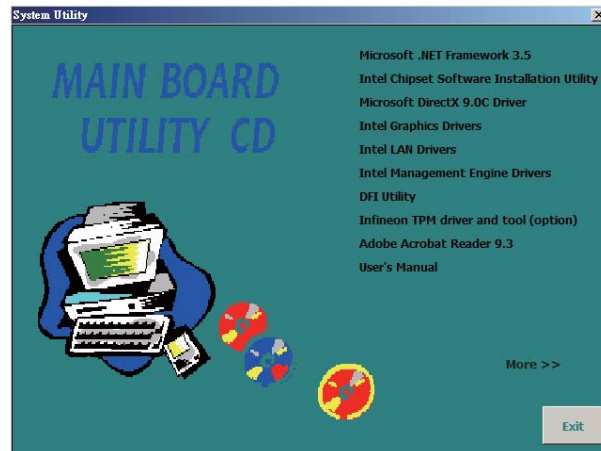

### Auto Run Pages (for Windows 7)

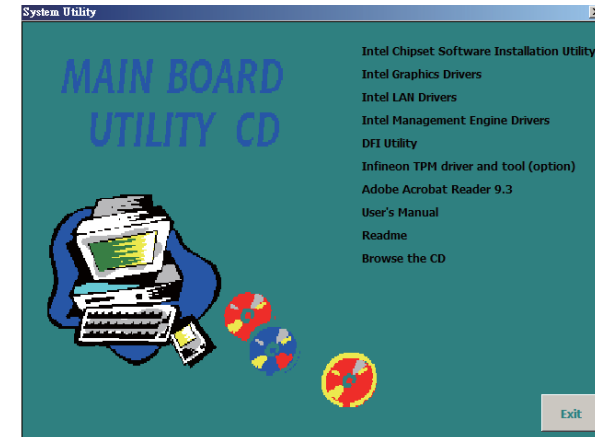

## Microsoft .NET Framework 3.5 (for Windows XP only)



**Note:**

Before installing Microsoft .NET Framework 3.5, make sure you have updated your Windows XP operating system to Service Pack 3.

To install the driver, click “Microsoft .NET Framework 3.5” on the main menu.

1. Read the license agreement carefully.

Click “I have read and accept the terms of the License Agreement” then click Install.

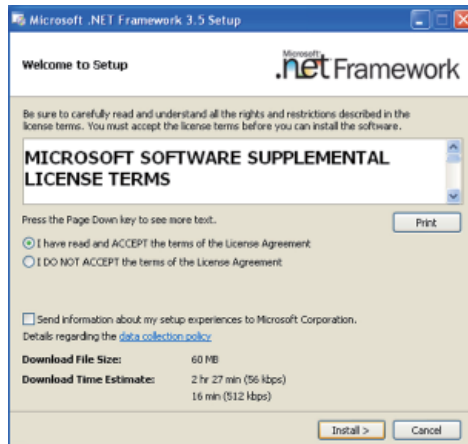

2. Setup is now installing the driver.

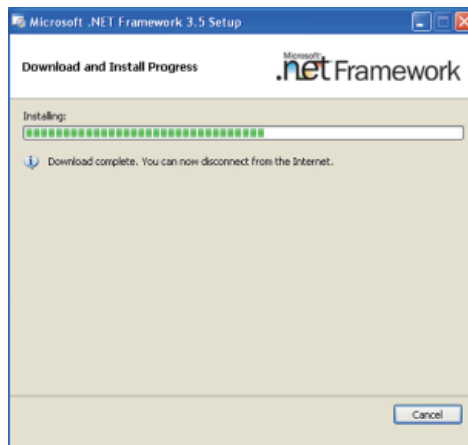

3. Click Exit.

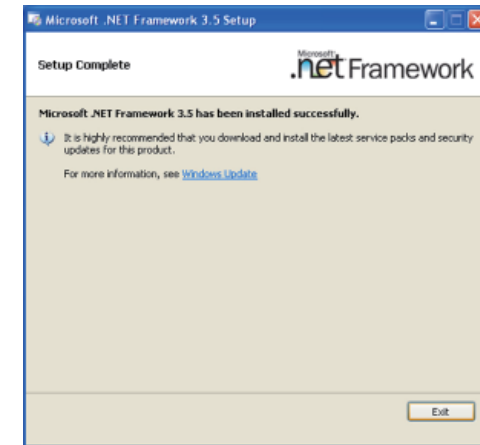

## Intel Chipset Software Installation Utility

The Intel Chipset Software Installation Utility is used for updating Windows® INF files so that the Intel chipset can be recognized and configured properly in the system.

To install the utility, click “Intel Chipset Software Installation Utility” on the main menu.

1. Setup is ready to install the utility. Click Next.



2. Read the license agreement then click Yes.



3. Go through the readme document for more installation tips then click Next.



4. Click Finish to exit setup.



## Microsoft DirectX 9.0C (for Windows XP only)

To install the driver, click “Microsoft DirectX 9.0C” on the main menu.

1. Click “I accept the agreement” then click Next.

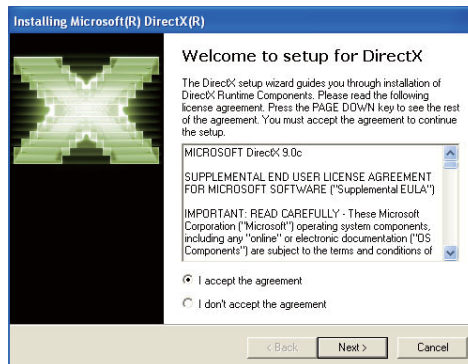

2. To start installation, click Next.

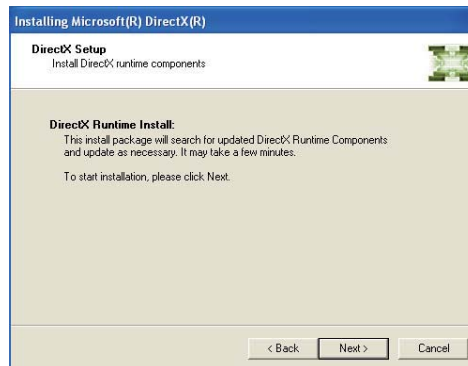

3. Click Finish. Reboot the system for DirectX to take effect.

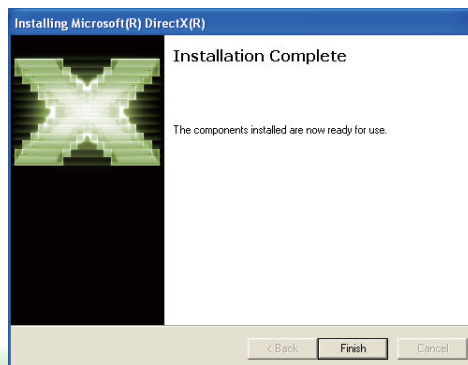

## Intel Graphics Drivers

To install the driver, click “Intel Graphics Drivers” on the main menu.

1. Setup is now ready to install the graphics driver. Click Next.

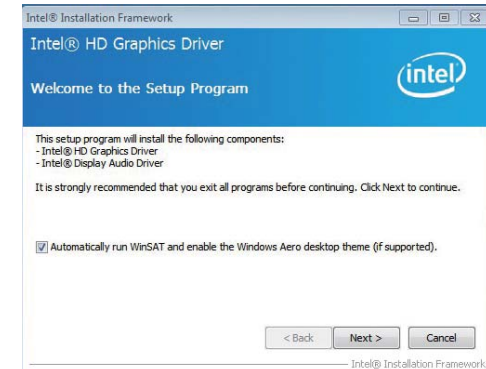

By default, the “Automatically run WinSAT and enable the Windows Aero desktop theme” is enabled. With this enabled, after installing the graphics driver and the system rebooted, the screen will turn blank for 1 to 2 minutes (while WinSAT is running) before the Windows Vista desktop appears. The “blank screen” period is the time Windows is testing the graphics performance.

2. Read the license agreement then click Yes.

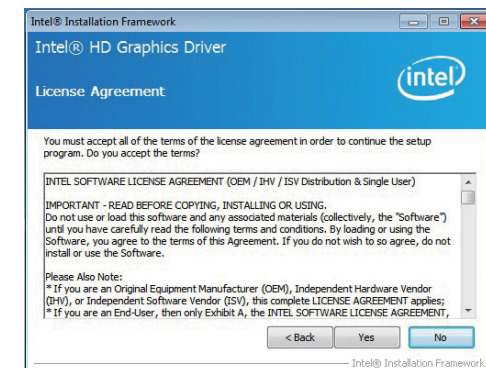

- Go through the readme document for system requirements and installation tips then click Next.

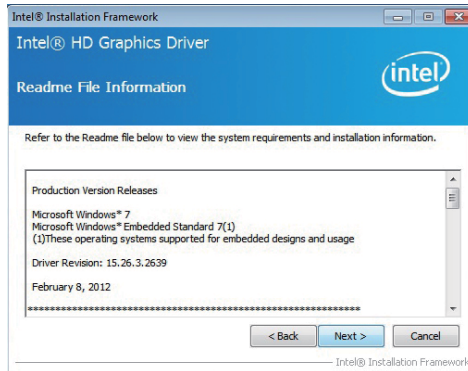

- Setup is now installing the driver. Click Next to continue.

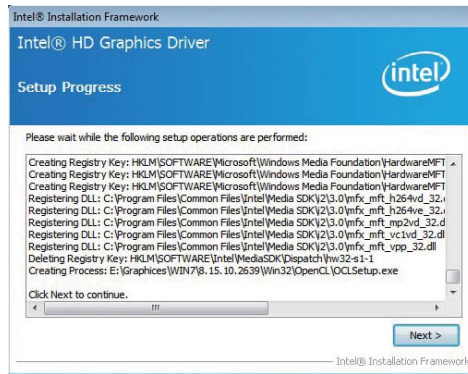

- Click "Yes, I want to restart this computer now" then click Finish.

Restarting the system will allow the new software installation to take effect.

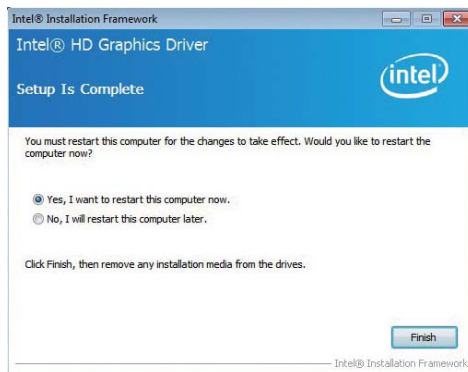

## Intel LAN Drivers

To install the driver, click "Intel LAN Drivers" on the main menu.

- Setup is ready to install the driver. Click Next.

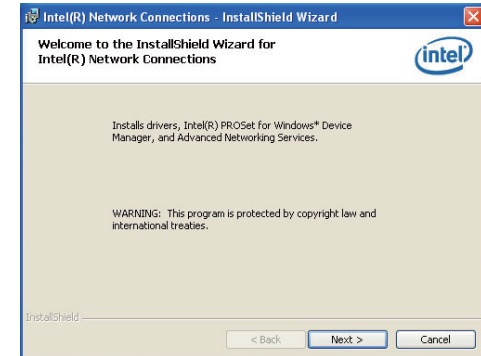

- Click "I accept the terms in the license agreement" then click "Next".

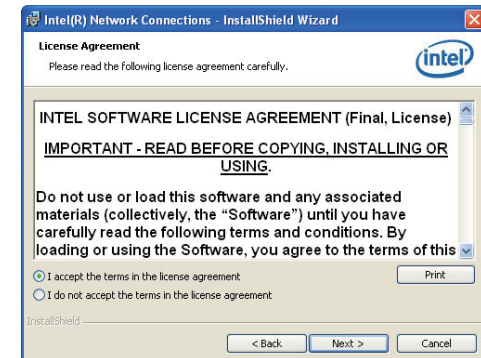

- Select the program features you want installed then click Next.

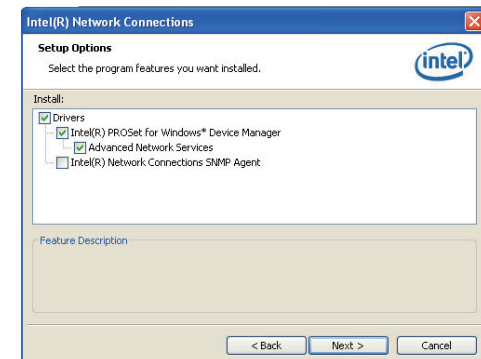



- Click Install to begin the installation.

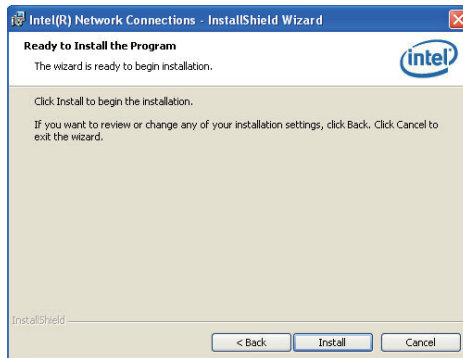

- After completing installation, click Finish.

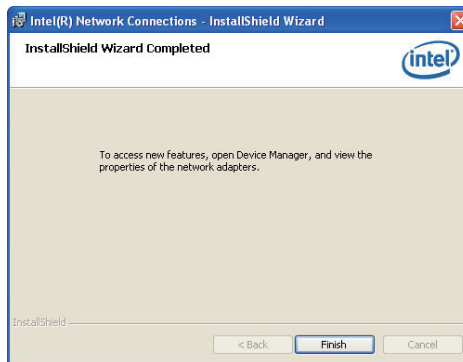

## Intel Management Engine Drivers

To install the driver, click "Intel Management Engine Drivers" on the main menu.

- Setup is ready to install the driver. Click Next.

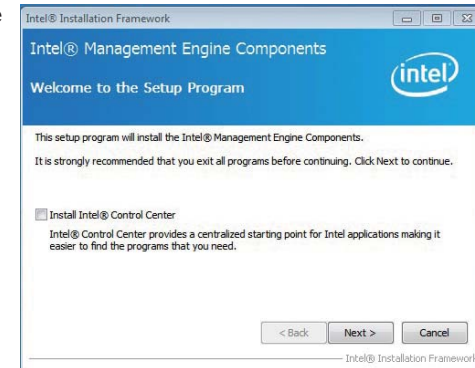

- Read the license agreement then click Yes.

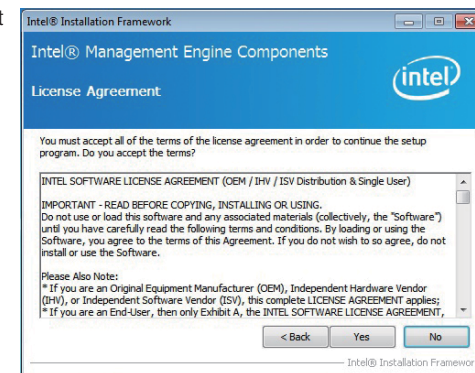

3. Setup is currently installing the driver. After installation has completed, click Next.

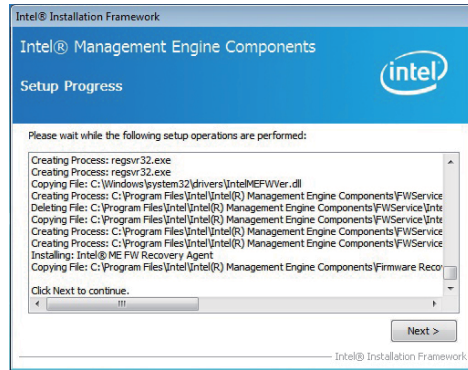

4. After completing installation, click Finish.

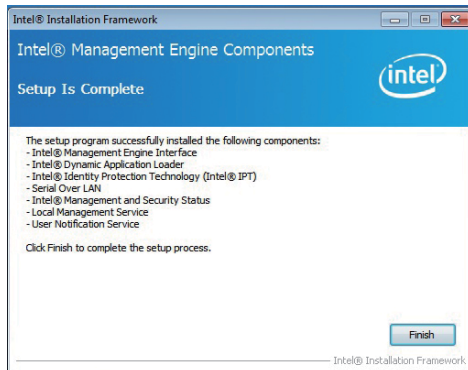

## DFI Utility

DFI Utility provides information about the board, Watchdog, and DIO. To access the utility, click “DFI Utility” on the main menu.



### Note:

If you are using Windows 7, you need to access the operating system as an administrator to be able to install the utility.

1. Setup is ready to install the DFI Utility driver. Click “Next”.



2. Click “I accept the terms in the license agreement” then click “Next”.

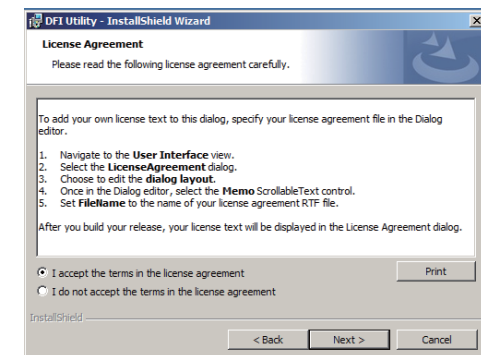



3. Enter "User name" (SB102) and "Organization" information then click "Next".

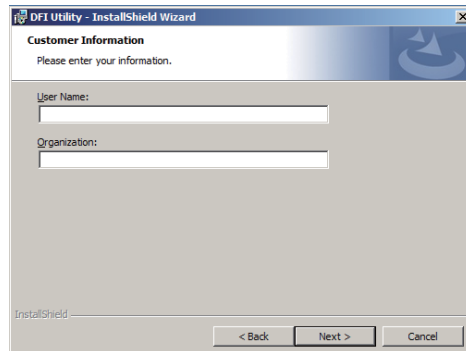

4. Click "Install" to begin the installation.

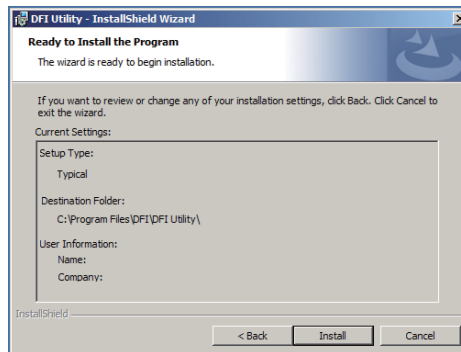

5. After completing installation, click "Finish".

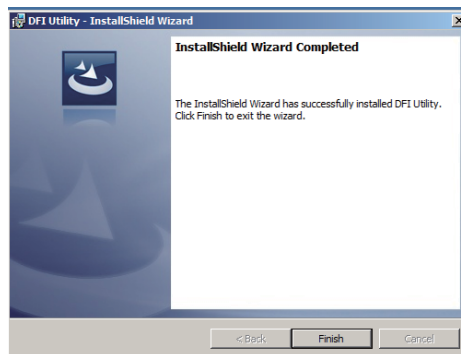

The DFI Utility icon will appear on the desktop. Double-click the icon to open the utility.



## Infinion TPM Driver and Tool (optional)

To install the driver, click “Infinion TPM driver and tool (option)” on the main menu.

1. TPM requires installing the Microsoft Visual C++ package prior to installing the driver. Click Install.

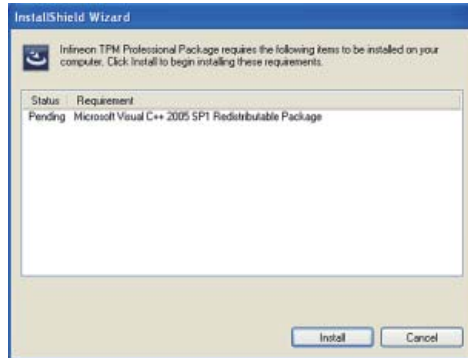

2. The setup program is preparing to install the driver.

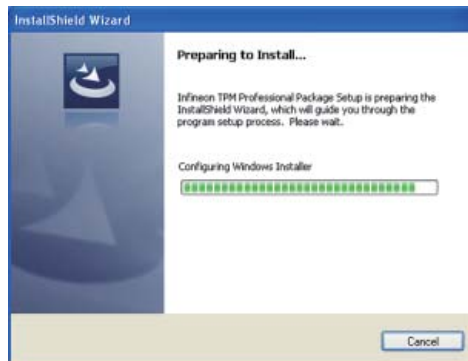

3. The setup program is ready to install the driver. Click Next.



4. Click “I accept the terms in the license agreement” and then click “Next”.

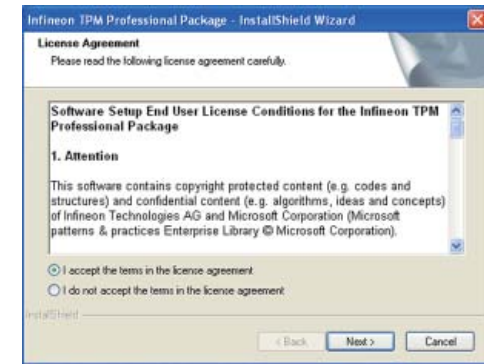

5. Enter the necessary information and then click Next.

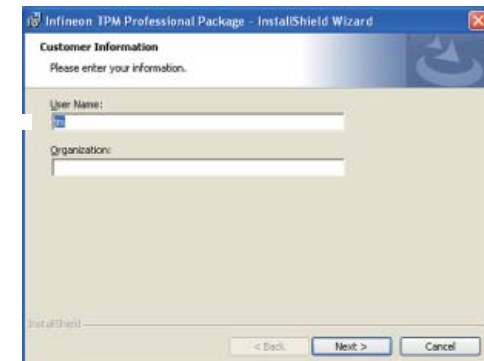

6. Select a setup type and then click Next.



7. Click Install.

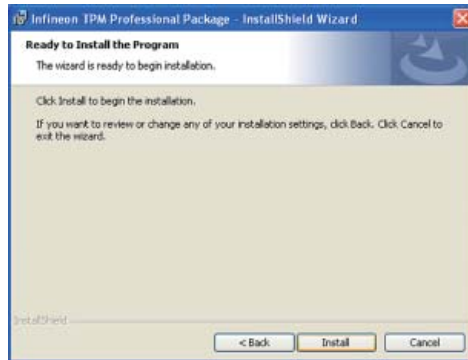

8. The setup program is currently installing the driver.

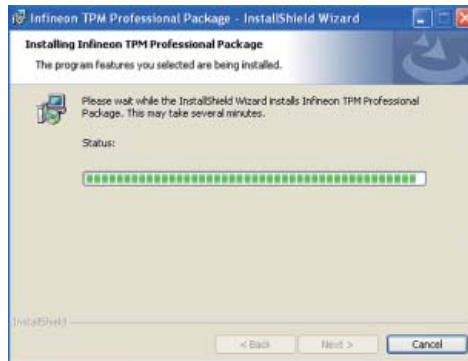

9. Click Finish.

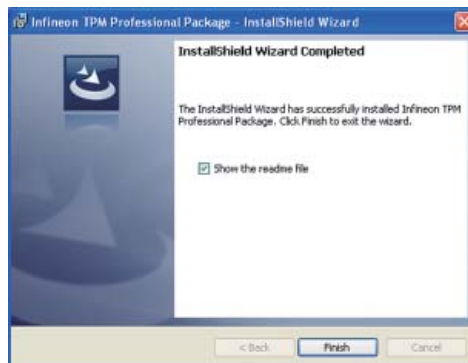

10. Click Yes to restart the system.

Restarting the system will allow the new software installation to take effect.

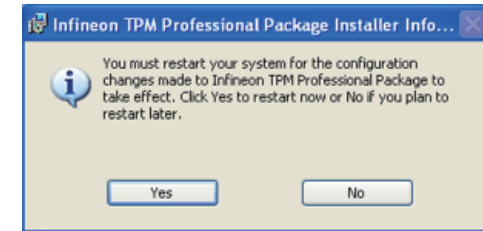

## Adobe Acrobat Reader 9.3

To install the reader, click “Adobe Acrobat Reader 9.3” on the main menu.

1. Click Next to install or click Change Destination Folder to select another folder.

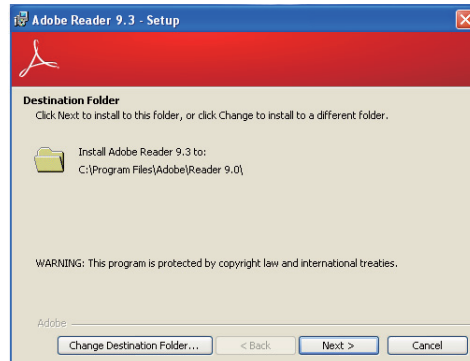

2. Click Install to begin installation.

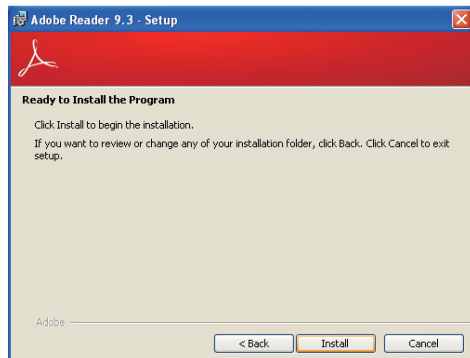

3. Click Finish to exit installation.

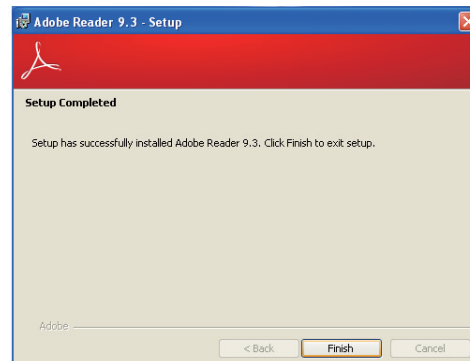

## Appendix A - Watchdog Sample Code

---

;Software programming example:

```

;-----
;(1) Enter Super IO Configuration mode
;-----
MOV     DX,2EH
MOV     AL,87H
OUT     DX,AL
OUT     DX,AL

;-----
;(2) Configuration Logical Device 7, register CRF5/CRF6 (WDT Control /WDT
timer)
;-----
MOV     DX,2EH
MOV     AL,07H           ;Ready to Program Logical Device
OUT     DX,AL

MOV     DX,2FH
MOV     AL,07H           ;Select Logical Device 7
OUT     DX,AL

MOV     DX,2EH
MOV     AL, F6H           ;Select watchdog timer register
OUT     DX,AL

MOV     DX,2FH
MOV     AL,10H           ;Set watchdog timer value
OUT     DX,AL

MOV     DX,2EH
MOV     AL, F5H           ;Select watchdog Control Register
OUT     DX,AL

MOV     DX,2FH
MOV     AL,61H           ;Set Watchdog Control Value
OUT     DX,AL

;-----
;(1) Exit extended function mode
;-----
MOV     DX,2EH
MOV     AL,AAH
OUT     DX,AL

```

## Appendix B - System Error Message

When the BIOS encounters an error that requires the user to correct something, either a beep code will sound or a message will be displayed in a box in the middle of the screen and the message, PRESS F1 TO CONTINUE, CTRL-ALT-ESC or DEL TO ENTER SETUP, will be shown in the information box at the bottom. Enter Setup to correct the error.

### Error Messages

One or more of the following messages may be displayed if the BIOS detects an error during the POST. This list indicates the error messages for all Awards BIOSes:

#### CMOS BATTERY HAS FAILED

The CMOS battery is no longer functional. It should be replaced.



**Important:**

Danger of explosion if battery incorrectly replaced. Replace only with the same or equivalent type recommended by the manufacturer. Dispose of used batteries according to the battery manufacturer's instructions.

#### CMOS CHECKSUM ERROR

Checksum of CMOS is incorrect. This can indicate that CMOS has become corrupt. This error may have been caused by a weak battery. Check the battery and replace if necessary.

#### DISPLAY SWITCH IS SET INCORRECTLY

The display switch on the motherboard can be set to either monochrome or color. This indicates the switch is set to a different setting than indicated in Setup. Determine which setting is correct, either turn off the system and change the jumper or enter Setup and change the VIDEO selection.

#### FLOPPY DISK(S) fail (80)

Unable to reset floppy subsystem.

#### FLOPPY DISK(S) fail (40)

Floppy type mismatch.

#### Hard Disk(s) fail (80)

HDD reset failed.

#### Hard Disk(s) fail (40)

HDD controller diagnostics failed.

#### Hard Disk(s) fail (20)

HDD initialization error.

#### Hard Disk(s) fail (10)

Unable to recalibrate fixed disk.

#### Hard Disk(s) fail (08)

Sector Verify failed.

#### Keyboard is locked out - Unlock the key

The BIOS detects that the keyboard is locked. Keyboard controller is pulled low.

#### Keyboard error or no keyboard present

Cannot initialize the keyboard. Make sure the keyboard is attached correctly and no keys are being pressed during the boot.

#### Manufacturing POST loop

System will repeat POST procedure infinitely while the keyboard controller is pull low. This is also used for the M/B burn in test at the factory.

#### BIOS ROM checksum error - System halted

The checksum of ROM address F0000H-FFFFFFH is bad.

#### Memory test fail

The BIOS reports memory test fail if the memory has error(s).

## Appendix C - Troubleshooting Checklist

### Troubleshooting Checklist

This chapter of the manual is designed to help you with problems that you may encounter with your personal computer. To efficiently troubleshoot your system, treat each problem individually. This is to ensure an accurate diagnosis of the problem in case a problem has multiple causes.

Some of the most common things to check when you encounter problems while using your system are listed below.

1. The power switch of each peripheral device is turned on.
2. All cables and power cords are tightly connected.
3. The electrical outlet to which your peripheral devices are connected is working. Test the outlet by plugging in a lamp or other electrical device.
4. The monitor is turned on.
5. The display's brightness and contrast controls are adjusted properly.
6. All add-in boards in the expansion slots are seated securely.
7. Any add-in board you have installed is designed for your system and is set up correctly.

### Monitor/Display

**If the display screen remains dark after the system is turned on:**

1. Make sure that the monitor's power switch is on.
2. Check that one end of the monitor's power cord is properly attached to the monitor and the other end is plugged into a working AC outlet. If necessary, try another outlet.
3. Check that the video input cable is properly attached to the monitor and the system's display adapter.
4. Adjust the brightness of the display by turning the monitor's brightness control knob.

**The picture seems to be constantly moving.**

1. The monitor has lost its vertical sync. Adjust the monitor's vertical sync.
2. Move away any objects, such as another monitor or fan, that may be creating a magnetic field around the display.
3. Make sure your video card's output frequencies are supported by this monitor.

**The screen seems to be constantly wavering.**

1. If the monitor is close to another monitor, the adjacent monitor may need to be turned off. Fluorescent lights adjacent to the monitor may also cause screen wavering.

### Power Supply

**When the computer is turned on, nothing happens.**

1. Check that one end of the AC power cord is plugged into a live outlet and the other end properly plugged into the back of the system.
2. Make sure that the voltage selection switch on the back panel is set for the correct type of voltage you are using.
3. The power cord may have a "short" or "open". Inspect the cord and install a new one if necessary.

### Floppy Drive

**The computer cannot access the floppy drive.**

1. The floppy diskette may not be formatted. Format the diskette and try again.
2. The diskette may be write-protected. Use a diskette that is not write-protected.
3. You may be writing to the wrong drive. Check the path statement to make sure you are writing to the targeted drive.
4. There is not enough space left on the diskette. Use another diskette with adequate storage space.

## Hard Drive

### Hard disk failure.

1. Make sure the correct drive type for the hard disk drive has been entered in the BIOS.
2. If the system is configured with two hard drives, make sure the bootable (first) hard drive is configured as Master and the second hard drive is configured as Slave. The master hard drive must have an active/bootable partition.

### Excessively long formatting period.

If your hard drive takes an excessively long period of time to format, it is likely a cable connection problem. However, if your hard drive has a large capacity, it will take a longer time to format.

## Serial Port

### The serial device (modem, printer) doesn't output anything or is outputting garbled characters.

1. Make sure that the serial device's power is turned on and that the device is on-line.
2. Verify that the device is plugged into the correct serial port on the rear of the computer.
3. Verify that the attached serial device works by attaching it to a serial port that is working and configured correctly. If the serial device does not work, either the cable or the serial device has a problem. If the serial device works, the problem may be due to the onboard I/O or the address setting.
4. Make sure the COM settings and I/O address are configured correctly.

## Keyboard

### Nothing happens when a key on the keyboard was pressed.

1. Make sure the keyboard is properly connected.
2. Make sure there are no objects resting on the keyboard and that no keys are pressed during the booting process.

## System Board

1. Make sure the add-in card is seated securely in the expansion slot. If the add-in card is loose, power off the system, re-install the card and power up the system.
2. Check the jumper settings to ensure that the jumpers are properly set.
3. Verify that all memory modules are seated securely into the memory sockets.
4. Make sure the memory modules are in the correct locations.
5. If the board fails to function, place the board on a flat surface and seat all socketed components. Gently press each component into the socket.
6. If you made changes to the BIOS settings, re-enter setup and load the BIOS defaults.



## Appendix D - BIOS Status Code

### Status Code Ranges

Status Code Range	Description
0x01 – 0x0F	SEC Status Codes & Errors
0x10 – 0x2F	PEI execution up to and including memory detection
0x30 – 0x4F	PEI execution after memory detection
0x50 – 0x5F	PEI errors
0x60 – 0xCF	DXE execution up to BDS
0xD0 – 0xDF	DXE errors
0xE0 – 0xE8	S3 Resume (PEI)
0xE9 – 0xEF	S3 Resume errors (PEI)
0xF0 – 0xF8	Recovery (PEI)
0xF9 – 0xFF	Recovery errors (PEI)

### Standard Status Codes

#### SEC Status Codes

Status Code	Description
0x0	Not used
<b>Progress Codes</b>	
0x1	Power on. Reset type detection (soft/hard).
0x2	AP initialization before microcode loading
0x3	North Bridge initialization before microcode loading
0x4	South Bridge initialization before microcode loading
0x5	OEM initialization before microcode loading
0x6	Microcode loading
0x7	AP initialization after microcode loading
0x8	North Bridge initialization after microcode loading
0x9	South Bridge initialization after microcode loading
0xA	OEM initialization after microcode loading
0xB	Cache initialization
<b>SEC Error Codes</b>	
0xC – 0xD	Reserved for future AMI SEC error codes
0xE	Microcode not found
0xF	Microcode not loaded

#### PEI Status Codes

Status Code	Description
<b>Progress Codes</b>	
0x10	PEI Core is started
0x11	Pre-memory CPU initialization is started
0x12	Pre-memory CPU initialization (CPU module specific)
0x13	Pre-memory CPU initialization (CPU module specific)
0x14	Pre-memory CPU initialization (CPU module specific)
0x15	Pre-memory North Bridge initialization is started
0x16	Pre-Memory North Bridge initialization (North Bridge module specific)
0x17	Pre-Memory North Bridge initialization (North Bridge module specific)
0x18	Pre-Memory North Bridge initialization (North Bridge module specific)
0x19	Pre-memory South Bridge initialization is started
0x1A	Pre-memory South Bridge initialization (South Bridge module specific)
0x1B	Pre-memory South Bridge initialization (South Bridge module specific)
0x1C	Pre-memory South Bridge initialization (South Bridge module specific)
0x1D – 0x2A	OEM pre-memory initialization codes
0x2B	Memory initialization. Serial Presence Detect (SPD) data reading
0x2C	Memory initialization. Memory presence detection
0x2D	Memory initialization. Programming memory timing information
0x2E	Memory initialization. Configuring memory
0x2F	Memory initialization (other).
0x30	Reserved for ASL (see ASL Status Codes section below)
0x31	Memory Installed
0x32	CPU post-memory initialization is started
0x33	CPU post-memory initialization. Cache initialization
0x34	CPU post-memory initialization. Application Processor(s) (AP) initialization
0x35	CPU post-memory initialization. Boot Strap Processor (BSP) selection
0x36	CPU post-memory initialization. System Management Mode (SMM) initialization
0x37	Post-Memory North Bridge initialization is started
0x38	Post-Memory North Bridge initialization (North Bridge module specific)
0x39	Post-Memory North Bridge initialization (North Bridge module specific)

0x3A	Post-Memory North Bridge initialization (North Bridge module specific)
0x3B	Post-Memory South Bridge initialization is started
0x3C	Post-Memory South Bridge initialization (South Bridge module specific)
0x3D	Post-Memory South Bridge initialization (South Bridge module specific)
0x3E	Post-Memory South Bridge initialization (South Bridge module specific)
0x3F-0x4E	OEM post memory initialization codes
0x4F	DXE IPL is started
<b>PEI Error Codes</b>	
0x50	Memory initialization error. Invalid memory type or incompatible memory speed
0x51	Memory initialization error. SPD reading has failed
0x52	Memory initialization error. Invalid memory size or memory modules do not match.
0x53	Memory initialization error. No usable memory detected
0x54	Unspecified memory initialization error.
0x55	Memory not installed
0x56	Invalid CPU type or Speed
0x57	CPU mismatch
0x58	CPU self test failed or possible CPU cache error
0x59	CPU micro-code is not found or micro-code update is failed
0x5A	Internal CPU error
0x5B	reset PPI is not available
0x5C-0x5F	Reserved for future AMI error codes
<b>S3 Resume Progress Codes</b>	
0xE0	S3 Resume is started (S3 Resume PPI is called by the DXE IPL)
0xE1	S3 Boot Script execution
0xE2	Video repost
0xE3	OS S3 wake vector call
0xE4-0xE7	Reserved for future AMI progress codes
0xE0	S3 Resume is started (S3 Resume PPI is called by the DXE IPL)
<b>S3 Resume Error Codes</b>	
0xE8	S3 Resume Failed in PEI
0xE9	S3 Resume PPI not Found
0xEA	S3 Resume Boot Script Error
0xEB	S3 OS Wake Error
0xEC-0xEF	Reserved for future AMI error codes
<b>Recovery Progress Codes</b>	
0xF0	Recovery condition triggered by firmware (Auto recovery)
0xF1	Recovery condition triggered by user (Forced recovery)
0xF2	Recovery process started

0xF3	Recovery firmware image is found
0xF4	Recovery firmware image is loaded
0xF5-0xF7	Reserved for future AMI progress codes
<b>Recovery Error Codes</b>	
0xF8	Recovery PPI is not available
0xF9	Recovery capsule is not found
0xFA	Invalid recovery capsule
0xFB – 0xFF	Reserved for future AMI error codes

### PEI Beep Codes

# of Beeps	Description
1	Memory not Installed
1	Memory was installed twice (InstallPeiMemory routine in PEI Core called twice)
2	Recovery started
3	DXE IPL was not found
3	DXE Core Firmware Volume was not found
7	Reset PPI is not available
4	Recovery failed
4	S3 Resume failed

### DXE Status Codes

Status Code	Description
0x60	DXE Core is started
0x61	NVRAM initialization
0x62	Installation of the South Bridge Runtime Services
0x63	CPU DXE initialization is started
0x64	CPU DXE initialization (CPU module specific)
0x65	CPU DXE initialization (CPU module specific)
0x66	CPU DXE initialization (CPU module specific)
0x67	CPU DXE initialization (CPU module specific)
0x68	PCI host bridge initialization
0x69	North Bridge DXE initialization is started
0x6A	North Bridge DXE SMM initialization is started
0x6B	North Bridge DXE initialization (North Bridge module specific)
0x6C	North Bridge DXE initialization (North Bridge module specific)
0x6D	North Bridge DXE initialization (North Bridge module specific)
0x6E	North Bridge DXE initialization (North Bridge module specific)
0x6F	North Bridge DXE initialization (North Bridge module specific)

0x70	South Bridge DXE initialization is started
0x71	South Bridge DXE SMM initialization is started
0x72	South Bridge devices initialization
0x73	South Bridge DXE Initialization (South Bridge module specific)
0x74	South Bridge DXE Initialization (South Bridge module specific)
0x75	South Bridge DXE Initialization (South Bridge module specific)
0x76	South Bridge DXE Initialization (South Bridge module specific)
0x77	South Bridge DXE Initialization (South Bridge module specific)
0x78	ACPI module initialization
0x79	CSM initialization
0x7A – 0x7F	Reserved for future AMI DXE codes
0x80 – 0x8F	OEM DXE initialization codes
0x90	Boot Device Selection (BDS) phase is started
0x91	Driver connecting is started
0x92	PCI Bus initialization is started
0x93	PCI Bus Hot Plug Controller Initialization
0x94	PCI Bus Enumeration
0x95	PCI Bus Request Resources
0x96	PCI Bus Assign Resources
0x97	Console Output devices connect
0x98	Console input devices connect
0x99	Super IO Initialization
0x9A	USB initialization is started
0x9B	USB Reset
0x9C	USB Detect
0x9D	USB Enable
0x9E – 0x9F	Reserved for future AMI codes
0xA0	IDE initialization is started
0xA1	IDE Reset
0xA2	IDE Detect
0xA3	IDE Enable
0xA4	SCSI initialization is started
0xA5	SCSI Reset
0xA6	SCSI Detect
0xA7	SCSI Enable
0xA8	Setup Verifying Password
0xA9	Start of Setup
0xAA	Reserved for ASL (see ASL Status Codes section below)

0xAB	Setup Input Wait
0xAC	Reserved for ASL (see ASL Status Codes section below)
0xAD	Ready To Boot event
0xAE	Legacy Boot event
0xAF	Exit Boot Services event
0xB0	Runtime Set Virtual Address MAP Begin
0xB1	Runtime Set Virtual Address MAP End
0xB2	Legacy Option ROM Initialization
0xB3	System Reset
0xB4	USB hot plug
0xB5	PCI bus hot plug
0xB6	Clean-up of NVRAM
0xB7	Configuration Reset (reset of NVRAM settings)
0xB8 – 0xBF	Reserved for future AMI codes
0xC0 – 0xCF	OEM BDS initialization codes
<b>DXE Error Codes</b>	
0xD0	CPU initialization error
0xD1	North Bridge initialization error
0xD2	South Bridge initialization error
0xD3	Some of the Architectural Protocols are not available
0xD4	PCI resource allocation error. Out of Resources
0xD5	No Space for Legacy Option ROM
0xD6	No Console Output Devices are found
0xD7	No Console Input Devices are found
0xD8	Invalid password
0xD9	Error loading Boot Option (LoadImage returned error)
0xDA	Boot Option is failed (StartImage returned error)
0xDB	Flash update is failed
0xDC	Reset protocol is not available

## DXE Beep Codes

# of Beeps	Description
4	Some of the Architectural Protocols are not available
5	No Console Output Devices are found
5	No Console Input Devices are found
1	Invalid password
6	Flash update is failed
7	Reset protocol is not available
8	Platform PCI resource requirements cannot be met

## ACPI/ASL Status Codes

Status Code	Description
0x01	System is entering S1 sleep state
0x02	System is entering S2 sleep state
0x03	System is entering S3 sleep state
0x04	System is entering S4 sleep state
0x05	System is entering S5 sleep state
0x10	System is waking up from the S1 sleep state
0x20	System is waking up from the S2 sleep state
0x30	System is waking up from the S3 sleep state
0x40	System is waking up from the S4 sleep state
0xAC	System has transitioned into ACPI mode. Interrupt controller is in PIC mode.
0xAA	System has transitioned into ACPI mode. Interrupt controller is in APIC mode.

## OEM-Reserved Status Code Ranges

Status Code	Description
0x5	OEM SEC initialization before microcode loading
0xA	OEM SEC initialization after microcode loading
0x1D – 0x2A	OEM pre-memory initialization codes
0x3F – 0x4E	OEM PEI post memory initialization codes
0x80 – 0x8F	OEM DXE initialization codes
0xC0 – 0xCF	OEM BDS initialization codes