

BW551

Embedded SBC 3.5"

User's Manual

Copyright

This publication contains information that is protected by copyright. No part of it may be reproduced in any form or by any means or used to make any transformation/adaptation without the prior written permission from the copyright holders.

This publication is provided for informational purposes only. The manufacturer makes no representations or warranties with respect to the contents or use of this manual and specifically disclaims any express or implied warranties of merchantability or fitness for any particular purpose. The user will assume the entire risk of the use or the results of the use of this document. Further, the manufacturer reserves the right to revise this publication and make changes to its contents at any time, without obligation to notify any person or entity of such revisions or changes.

Changes after the publication's first release will be based on the product's revision. The website will always provide the most updated information.

© 2016. All Rights Reserved.

Trademarks

Product names or trademarks appearing in this manual are for identification purpose only and are the properties of the respective owners.

FCC and DOC Statement on Class B

This equipment has been tested and found to comply with the limits for a Class B digital device, pursuant to Part 15 of the FCC rules. These limits are designed to provide reasonable protection against harmful interference when the equipment is operated in a residential installation. This equipment generates, uses and can radiate radio frequency energy and, if not installed and used in accordance with the instruction manual, may cause harmful interference to radio communications. However, there is no guarantee that interference will not occur in a particular installation. If this equipment does cause harmful interference to radio or television reception, which can be determined by turning the equipment off and on, the user is encouraged to try to correct the interference by one or more of the following measures:

- Reorient or relocate the receiving antenna.
- Increase the separation between the equipment and the receiver.
- Connect the equipment into an outlet on a circuit different from that to which the receiver is connected.
- Consult the dealer or an experienced radio TV technician for help.

Notice:

1. The changes or modifications not expressly approved by the party responsible for compliance could void the user's authority to operate the equipment.
2. Shielded interface cables must be used in order to comply with the emission limits.

Table of Contents

Copyright.....	2
Trademarks.....	2
FCC and DOC Statement on Class B.....	2
About this Manual	4
Warranty.....	4
Static Electricity Precautions.....	4
Safety Measures.....	4
About the Package	5
Chapter 1 - Introduction.....	6
Specifications.....	6
Features	7
Chapter 2 - Hardware Installation.....	8
Board Layout.....	8
Block Diagram.....	9
Mechanical Diagram.....	9
System Memory.....	10
Jumper Settings	10
Clear CMOS Data	10
Auto Power-on Select	11
Backlight Power Select.....	11
Panel Power Select.....	12
LVDS Channel and bpp Select.....	12
Rear Panel I/O Ports.....	13
12V DC-in	13
Graphics Interfaces	14
RJ45 LAN Ports.....	14
USB Ports.....	15
I/O Connectors.....	16
Digital I/O Connector.....	16
Front Audio Connector.....	16
COM (Serial) Ports	17

COM Port Connector	17
Standby Power LED	18
Front Panel Connector	18
SATA (Serial ATA) Connector	19
SATA (Serial ATA) Power Connector	19
LVDS LCD Panel Connector.....	20
LCD/Inverter Power Connector.....	20
Expansion Slot.....	21
Cooling Fan Connector.....	21
SMBus Connector	22
Chassis Intrusion Connector	22
Battery	23

Chapter 3 - BIOS Setup.....24

Overview	24
Insyde BIOS Setup Utility.....	25
Main	25
Advanced	25
Security	33
Boot	34
Exit	34
Updating the BIOS.....	35
Notice: BIOS SPI ROM.....	35

Chapter 4 - Supported Software.....36

Appendix A - System Error Message.....48

Appendix B - Troubleshooting Checklist.....49

About this Manual

An electronic file of this manual is included in the DVD. To view the user's manual in the DVD, insert the DVD into a DVD-ROM drive. The autorun screen (Main Board Utility DVD) will appear. Click "User's Manual" on the main menu.

Warranty

1. Warranty does not cover damages or failures that arised from misuse of the product, inability to use the product, unauthorized replacement or alteration of components and product specifications.
2. The warranty is void if the product has been subjected to physical abuse, improper installation, modification, accidents or unauthorized repair of the product.
3. Unless otherwise instructed in this user's manual, the user may not, under any circumstances, attempt to perform service, adjustments or repairs on the product, whether in or out of warranty. It must be returned to the purchase point, factory or authorized service agency for all such work.
4. We will not be liable for any indirect, special, incidental or consequential damages to the product that has been modified or altered.

Static Electricity Precautions

It is quite easy to inadvertently damage your PC, system board, components or devices even before installing them in your system unit. Static electrical discharge can damage computer components without causing any signs of physical damage. You must take extra care in handling them to ensure against electrostatic build-up.

1. To prevent electrostatic build-up, leave the system board in its anti-static bag until you are ready to install it.
2. Wear an antistatic wrist strap.
3. Do all preparation work on a static-free surface.
4. Hold the device only by its edges. Be careful not to touch any of the components, contacts or connections.
5. Avoid touching the pins or contacts on all modules and connectors. Hold modules or connectors by their ends.



Important:

Electrostatic discharge (ESD) can damage your processor, disk drive and other components. Perform the upgrade instruction procedures described at an ESD workstation only. If such a station is not available, you can provide some ESD protection by wearing an antistatic wrist strap and attaching it to a metal part of the system chassis. If a wrist strap is unavailable, establish and maintain contact with the system chassis throughout any procedures requiring ESD protection.

Safety Measures

To avoid damage to the system:

- Use the correct AC input voltage range.

To reduce the risk of electric shock:

- Unplug the power cord before removing the system chassis cover for installation or servicing. After installation or servicing, cover the system chassis before plugging the power cord.

About the Package

The package contains the following items. If any of these items are missing or damaged, please contact your dealer or sales representative for assistance.

- One BW551 board
- One COM port cable (Length: 300mm)
- One Serial ATA data cable (Length: 500mm)
- One Serial ATA power cable (Length: 250mm)
- One DVD
- One QR
- One Heat sink (Height: 16.5mm)

Optional Items

- USB port cable (Length: 200mm)
- COM port cable (Length: 300mm)
- Power adapter (60W, 12V)
- Heat spreader (Height: 8mm)
- Audio cable (Length: 160mm)

The board and accessories in the package may not come similar to the information listed above. This may differ in accordance to the sales region or models in which it was sold. For more information about the standard package in your region, please contact your dealer or sales representative.

Before Using the System Board

Before using the system board, prepare basic system components. If you are installing the system board in a new system, you will need at least the following internal components.

- Storage devices such as hard disk drive, DVD-ROM, etc.

You will also need external system peripherals you intend to use which will normally include at least a keyboard, a mouse and a video display monitor.

Chapter 1 - Introduction

Specifications

SYSTEM	Processor	Intel® Pentium®/Celeron® Processor N3000 Family, BGA 1170 (*) Intel® Atom™ Processor x5-E8000, Quad Core, 2M Cache, 1.04GHz, 5W Intel® Pentium® Processor N3710, Quad Core, 2M Cache, 1.6GHz (2.56GHz), 6W Intel® Celeron® Processor N3160, Quad Core, 2M Cache, 1.6GHz (2.24GHz), 6W Intel® Celeron® Processor N3060, Dual Core, 2M Cache, 1.6GHz (2.48GHz), 6W Intel® Celeron® Processor N3010, Dual Core, 2M Cache, 1.04GHz (2.24GHz), 4W
	Memory	One 204-pin SODIMM up to 8GB Single Channel DDR3L 1600MHz
	BIOS	Insyde SPI 64Mbit
	GRAPHICS	Controller Intel® HD Graphics
	Feature	OpenGL 4.2, Direct X 11.1, OpenCL 1.2, OGL ES 3.0 HW Decode: H.264, MPEG2, VC1, VP8, H.265, MPEG4 HW Encode: H.264, MPEG2, MPEG4
	Display	1 x VGA VGA: resolution up to 2560x1600 @ 60Hz 1 x LVDS LVDS: dual channel 48-bit, resolution up to 1920x1200 @ 60Hz 1 x DP++ DP: resolution up to 3840x2160 @ 30Hz or 2560x1600 @ 60Hz
	Triple Displays	VGA + LVDS + DP++
EXPANSION	Interface	1 x Half-size Mini PCIe (PCIe/USB) 1 x Full-size mSATA (USB/SATA) 1 x SIM (optional)
AUDIO	Audio Codec	Realtek ALC888S-VD2-GR
ETHERNET	Controller	2 x Intel® I211AT PCIe (10/100/1000Mbps)
REAR I/O	Ethernet	2 x GbE (RJ-45)
	USB	4 x USB 3.0
	Display	1 x VGA 1 x DP++
INTERNAL I/O	Serial	2 x RS-232/422/485 (RS-232 w/ power) (2.0mm pitch) 2 x RS-232 (2.0mm pitch)
	USB	2 x USB 2.0 (2.0mm pitch)
	Display	1 x LVDS LCD Panel Connector 1 x LCD/Inverter Power
	Audio	1 x Audio (Line-out/Mic-in)
	SATA	1 x SATA 3.0 (up to 6Gb/s) 1 x SATA Power
	DIO	1 x 8-bit DIO
	SMBus	1 x SMBus
WATCHDOG TIMER	Output & Interval	System Reset, Programmable via Software from 1 to 255 Seconds
SECURITY	TPM	Available Upon Request

POWER	Type	Single 12V +/-10% DC
	Connector	DC-in Jack Right Angle Connector (4-pin) (available upon request) Vertical Type Connector (4-pin) (available upon request)
	Consumption	BW551 Typical: N3710:12V @ 0.53A (6.36Watt) Max.: N3710:12V @ 1.14A (13.68Watt)
	RTC Battery	Lithium 3V (210mAH)
OS SUPPORT	Microsoft/ Linux	Windows 7 (/WES7) 32/64-bit Windows 8.1 (64-bit) Windows 10 IoT Enterprise 32/64-bit Debian 8 (with VESA graphic driver) CentOS 7 (with VESA graphic driver) Ubuntu 15.10 (Intel graphic driver available)
	ENVIRONMENT	Temperature Operating: 0 to 60°C Storage: -40 to 85°C
	Humidity	Operating: 10 to 90% RH Storage: 10 to 90% RH
	MTBF	BW551 : 411,490 hrs @ 25°C; 250,359 hrs @ 45°C ; 160,650 hrs @ 60°C
MECHANICAL	Dimensions	3.5" SBC Form Factor 146mm (5.75") x 102mm (4.02")
	Height	PCB: 1.6mm Top Side: 15.5mm, Bottom Side: 8.0mm

*When PXE function is used with the UEFI boot type, the client screen might display partial screen if the PXE server employs a graphical user interface (GUI)-based management interface. This problem is due to resolution compatibility between the server and the client.

Features

• Watchdog Timer

The Watchdog Timer function allows your application to regularly “clear” the system at the set time interval. If the system hangs or fails to function, it will reset at the set time interval so that your system will continue to operate.

• DDR3L

DDR3L is a higher performance DDR3 SDRAM interface providing less voltage and higher speed successor. DDR3L SDRAM supports 1600MHz. DDR3L delivers increased system bandwidth and improved performance to provide its higher bandwidth and its increase in performance at a lower power.

• Graphics

The integrated Intel® HD graphics engine delivers an excellent blend of graphics performance and features to meet business needs. It provides excellent video and 3D graphics with outstanding graphics responsiveness. These enhancements deliver the performance and compatibility needed for today's and tomorrow's business applications. Supports 1 VGA, 1 LVDS and 1 DP++ interfaces for display outputs.

• Serial ATA

Serial ATA is a storage interface that is compliant with SATA 1.0a specification. With speed of up to 6Gb/s (SATA 3.0), it improves hard drive performance faster than the standard parallel ATA whose data transfer rate is 100MB/s.

• Gigabit LAN

Two Intel® I211AT PCI Express Gigabit Ethernet controllers support up to 1Gbps data transmission.

• Audio

The Realtek ALC888S-VD2-GR audio codec provides 5.1-channel High Definition audio output.

• Power Failure Recovery

When power returns after an AC power failure, you may choose to either power-on the system manually or let the system power-on automatically.

• USB

The system board supports the new USB 3.0. It is capable of running at a maximum transmission speed of up to 5 Gbit/s (625 MB/s) and is faster than USB 2.0 (480 Mbit/s, or 60 MB/s) and USB 1.1 (12Mb/s). USB 3.0 reduces the time required for data transmission, reduces power consumption, and is backward compatible with USB 2.0. It is a marked improvement in device transfer speeds between your computer and a wide range of simultaneously accessible external Plug and Play peripherals.

• Wake-On-LAN

This feature allows the network to remotely wake up a Soft Power Down (Soft-Off) PC. It is supported via the onboard LAN port or via a PCI LAN card that uses the PCI PME (Power Management Event) signal. However, if your system is in the Suspend mode, you can power-on the system only through an IRQ or DMA interrupt.



Important:

The 5V_standby power source of your power supply must support $\geq 720\text{mA}$.

• Wake-On-USB (Optional)

This function allows you to use a USB keyboard or USB mouse to wake up a system from the S3 (STR - Suspend To RAM) state.



Important:

If you are using the Wake-On-USB Keyboard/Mouse function for 2 USB ports, the 5V_standby power source of your power supply must support $\geq 1.5\text{A}$. For 3 or more USB ports, the 5V_standby power source of your power supply must support $\geq 2\text{A}$.

• ACPI STR

The system board is designed to meet the ACPI (Advanced Configuration and Power Interface) specification. ACPI has energy saving features that enables PCs to implement Power Management and Plug-and-Play with operating systems that support OS Direct Power Management. ACPI when enabled in the Power Management Setup will allow you to use the Suspend to RAM function.

With the Suspend to RAM function enabled, you can power-off the system at once by pressing the power button or selecting “Standby” when you shut down Windows® without having to go through the sometimes tiresome process of closing files, applications and operating system. This is because the system is capable of storing all programs and data files during the entire operating session into RAM (Random Access Memory) when it powers-off. The operating session will resume exactly where you left off the next time you power-on the system.



Important:

The 5V_standby power source of your power supply must support $\geq 720\text{mA}$.

• RTC Timer

The RTC installed on the system board allows your system to automatically power-on on the set date and time.

Chapter 2 - Hardware Installation

Board Layout

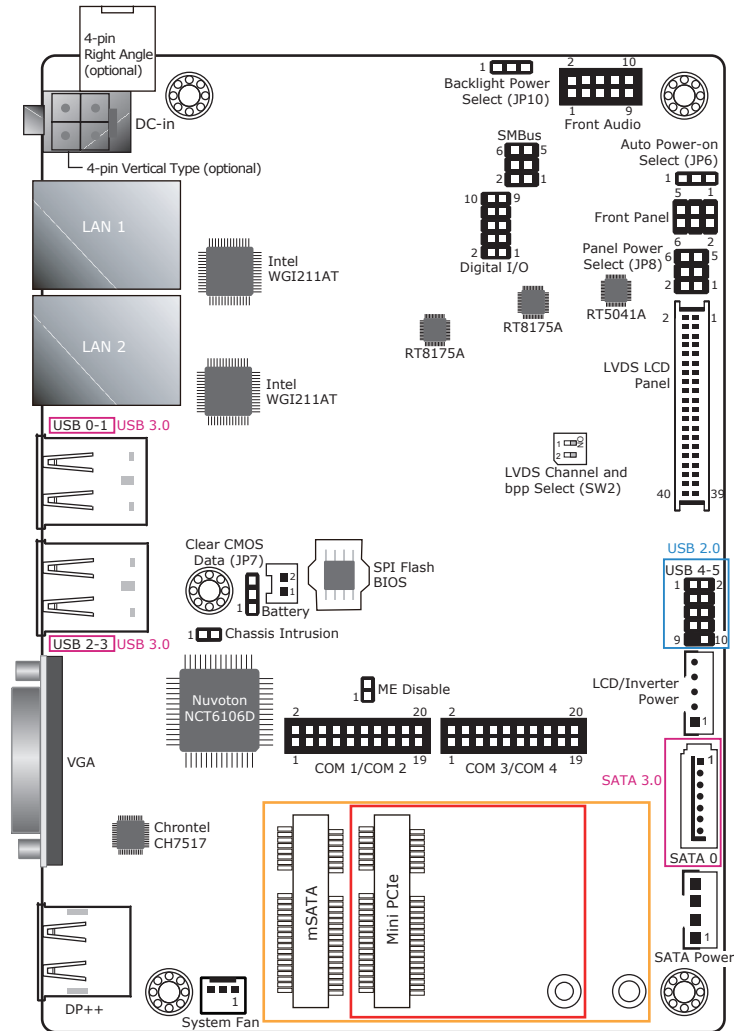

Top View

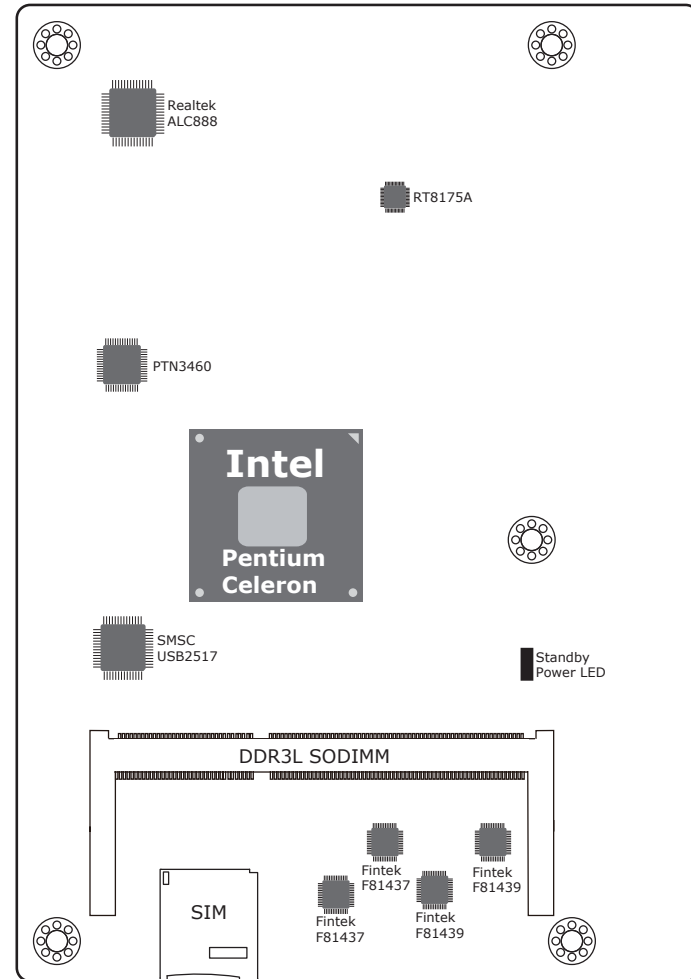

Bottom View

Block Diagram

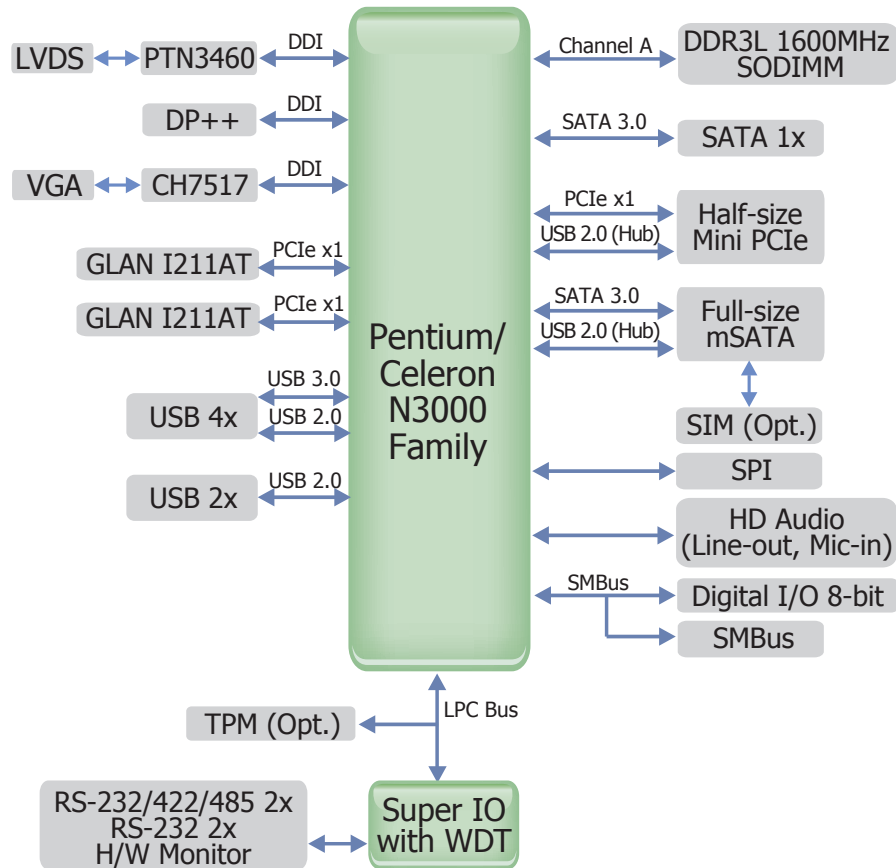

Mechanical Diagram

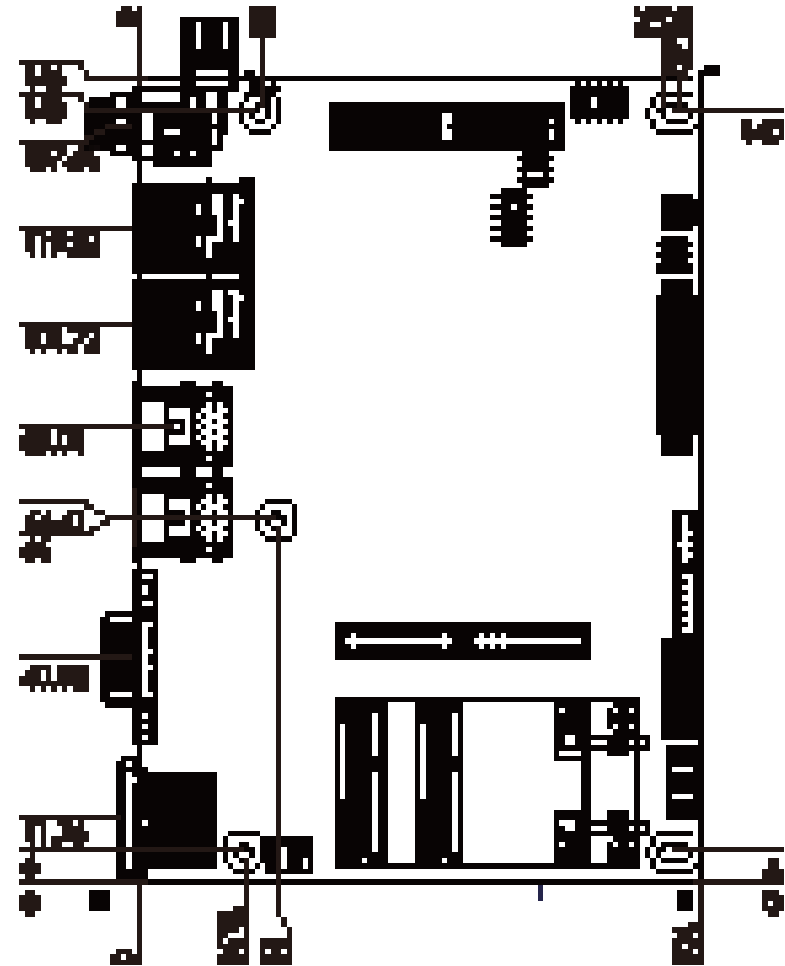

**Important:**

Electrostatic discharge (ESD) can damage your board, processor, disk drives, add-in boards, and other components. Perform installation procedures at an ESD workstation only. If such a station is not available, you can provide some ESD protection by wearing an antistatic wrist strap and attaching it to a metal part of the system chassis. If a wrist strap is unavailable, establish and maintain contact with the system chassis throughout any procedures requiring ESD protection.

System Memory

**Important:**

When the Standby Power LED lights red, it indicates that there is power on the system board. Power-off the PC then unplug the power cord prior to installing any devices. Failure to do so will cause severe damage to the motherboard and components.

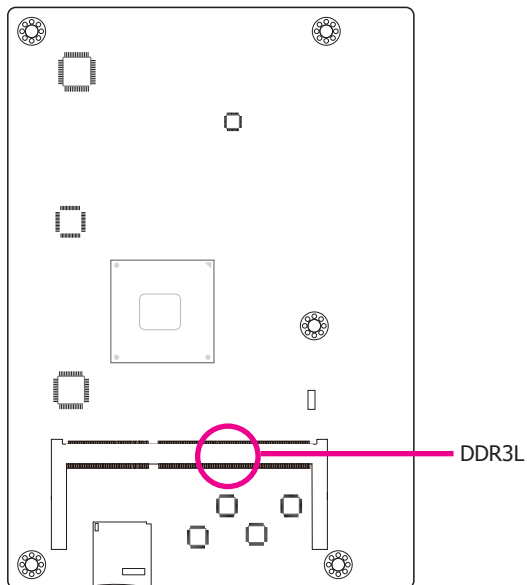

Features

- One 204-pin SODIMM up to 8GB
- Single Channel DDR3L 1600MHz

Jumper Settings

Clear CMOS Data

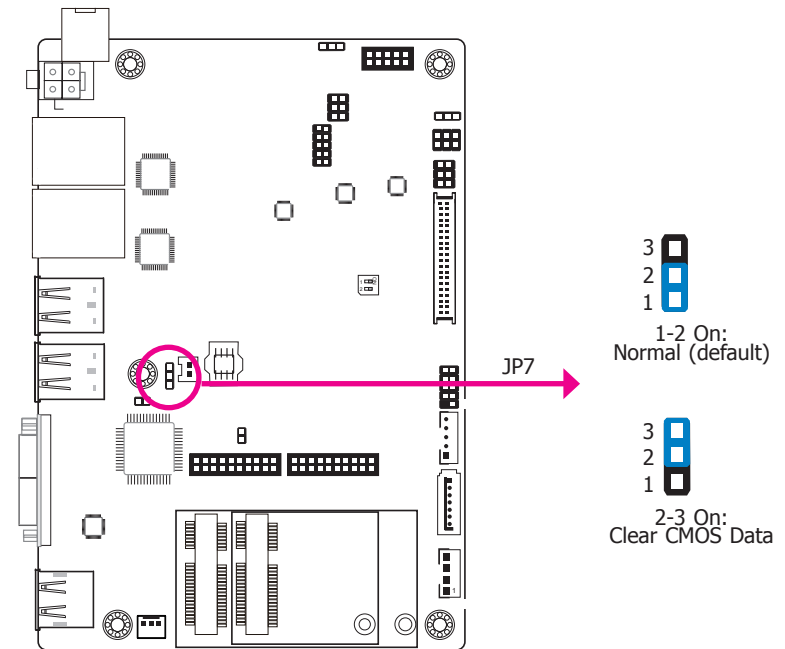

If you encounter the following,

- a) CMOS data becomes corrupted.
- b) You forgot the supervisor or user password.

you can reconfigure the system with the default values stored in the ROM BIOS.

To load the default values stored in the ROM BIOS, please follow the steps below.

1. Power-off the system and unplug the power cord.
2. Set JP7 pins 2 and 3 to On. Wait for a few seconds and set JP7 back to its default setting, pins 1 and 2 On.
3. Now plug the power cord and power-on the system.

Auto Power-on Select

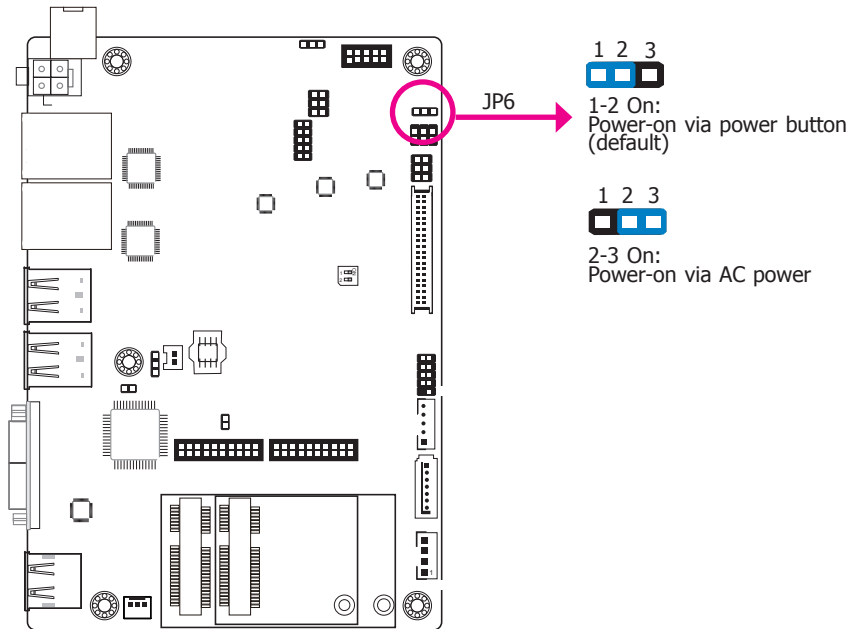

JP6 is used to select the method of powering on the system. If you want the system to power-on whenever AC power comes in, set JP6 pins 2 and 3 to On. If you want to use the power button, set JP6 pins 1 and 2 to On.

When using the JP6 "Power On" feature to power the system back on after a power failure occurs, the system may not power on if the power lost is resumed within 5 seconds (power flicker).

Backlight Power Select

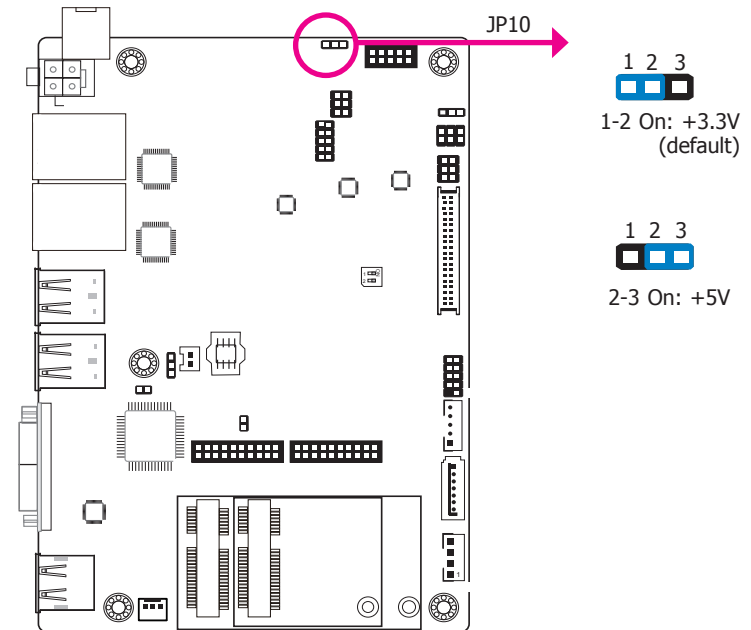

JP10 is used to select the power level of backlight brightness control: +3.3V or +5V.



Important:

Before powering-on the system, make sure that the power settings of JP10 match the power specification of backlight control. Selecting the incorrect voltage will seriously damage the backlight.

Panel Power Select

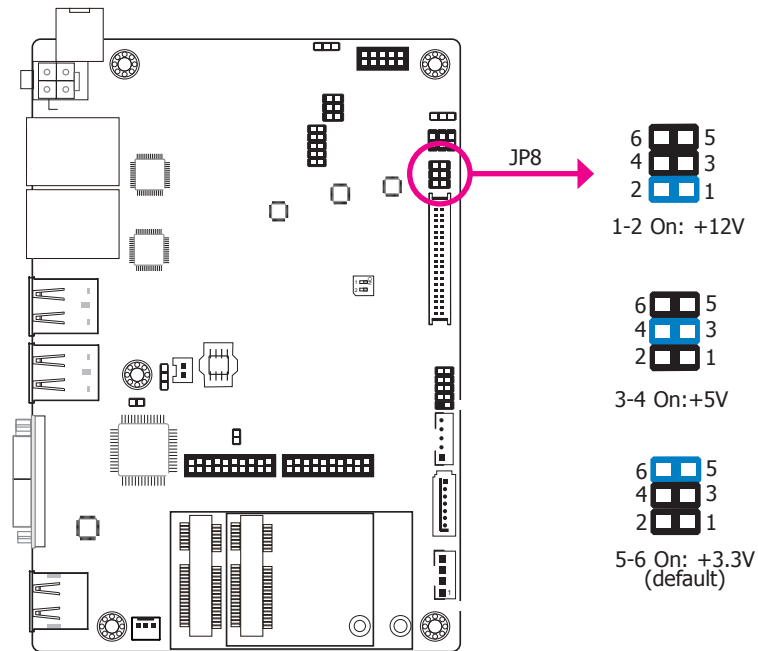

JP8 is used to select the power supplied with the LCD panel.

**Important:**

Before powering-on the system, make sure that the power settings of JP8 match the LCD panel's specification. Selecting the incorrect voltage will seriously damage the LCD panel.

LVDS Channel and bpp Select

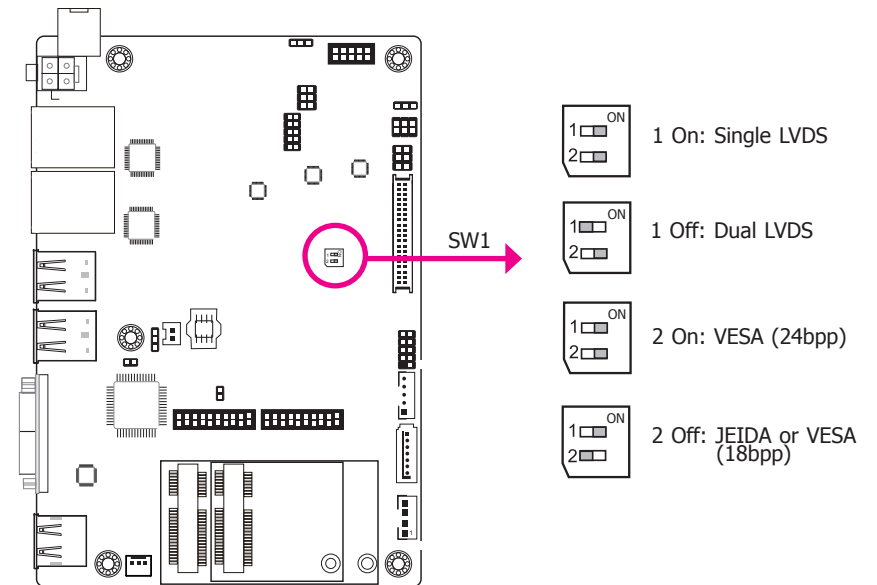

Switch 1 allows you to select the LVDS channel and the color of bits per pixel.

Rear Panel I/O Ports

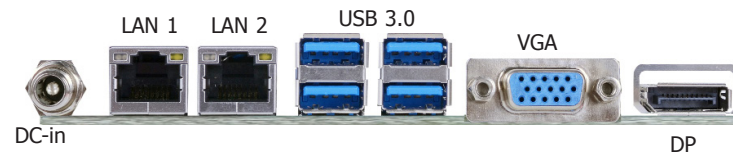

The rear panel I/O ports consist of the following:

- DC-in Jack
- 2 GbE (RJ-45)
- 4 USB 3.0 ports
- 1 VGA port
- 1 DP++ port

12V DC-in

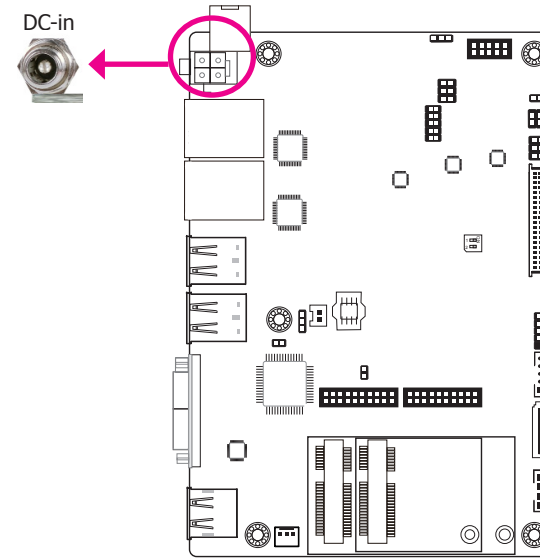

This jack is considered a low power solution. Connect a DC power cord to this jack. Using a voltage more than the recommended range may fail to boot the system or cause damage to the system board.

The DC-in jack on the system board co-lays with a 4-pin right angle connector (optional) or 4-pin vertical Type connector (optional) as the photo displayed below.

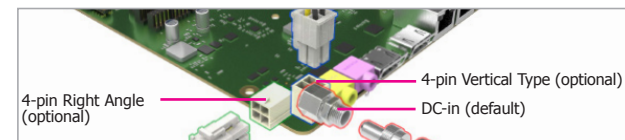

Graphics Interfaces

The display ports consist of the following:

- 1 DP++ port
- 1 VGA port

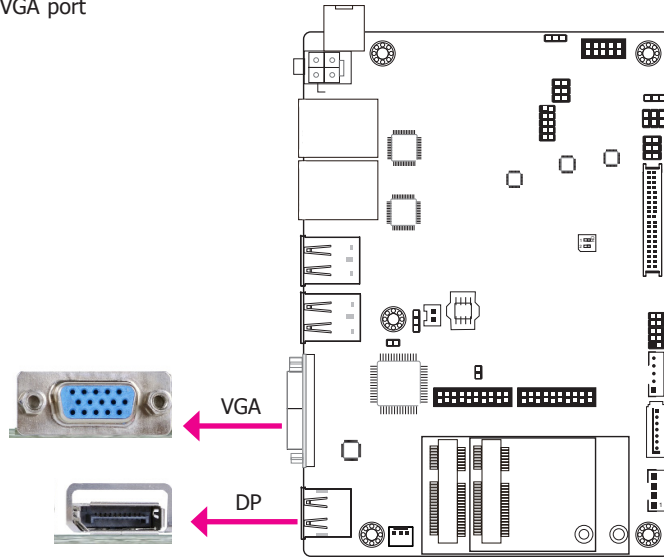

VGA Port

The VGA port is used for connecting a VGA monitor. Connect the monitor's 15-pin D-shell cable connector to the VGA port. After you plug the monitor's cable connector into the VGA port, gently tighten the cable screws to hold the connector in place.

DP Port

The DisplayPort is a digital display interface used to connect a display device such as a computer monitor. It is used to transmit audio and video simultaneously. The interface, which is developed by VESA, delivers higher performance features than any other digital interface.

Driver Installation

Install the graphics driver. Refer to chapter 4 for more information.

RJ45 LAN Ports

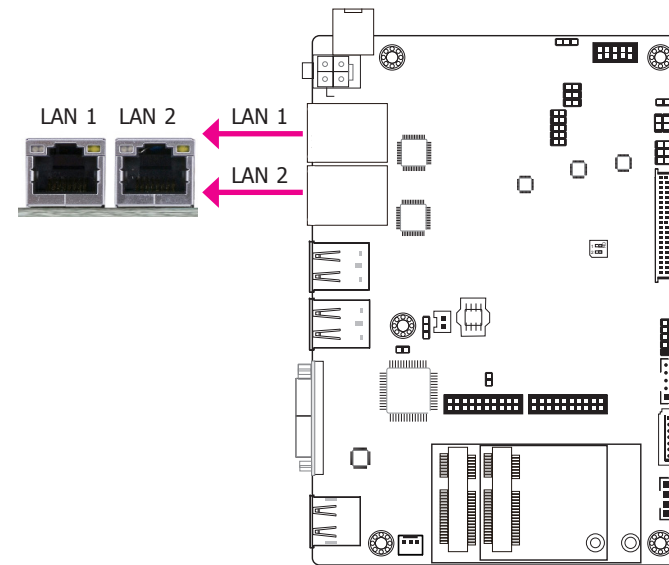

Features

- 2 Intel® I211AT PCI Express Gigabit Ethernet controllers

The LAN ports allow the system board to connect to a local area network by means of a network hub.

BIOS Setting

Configure the onboard LAN in the Chipset menu ("PCH-IO Configuration" submenu) of the BIOS. Refer to chapter 3 for more information.

Driver Installation

Install the LAN drivers. Refer to chapter 4 for more information.

USB Ports

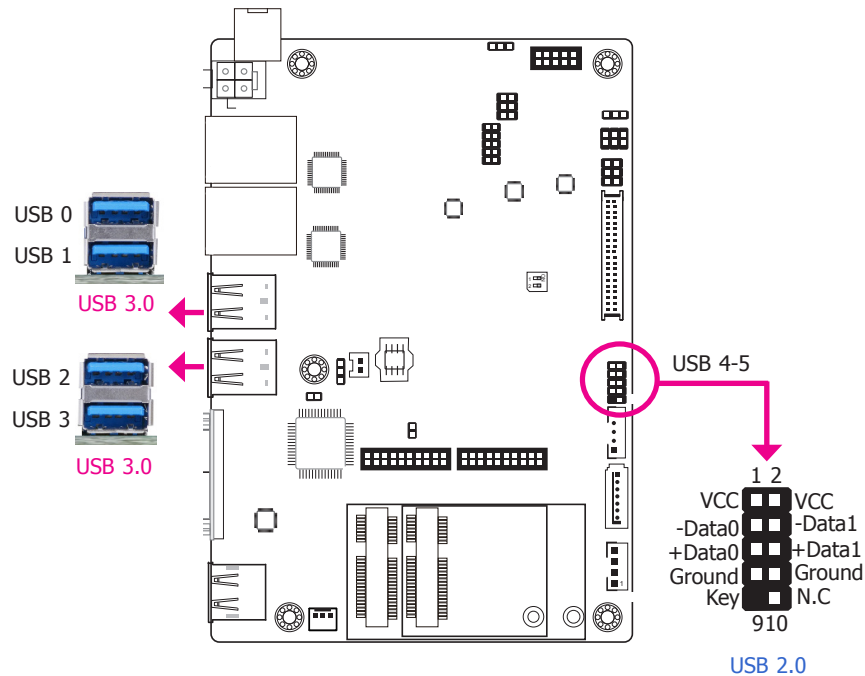

The USB device allows data exchange between your computer and a wide range of simultaneously accessible external Plug and Play peripherals.

The system board is equipped with one onboard USB 3.0 port (USB 0-1/2-3). The 10-pin connector allows you to connect 2 additional USB 2.0 ports (USB 4-5). The additional USB ports may be mounted on a card-edge bracket. Install the card-edge bracket to an available slot at the rear of the system chassis and then insert the USB port cables to a connector.

BIOS Setting

Configure the onboard USB in the Advanced menu ("USB Configuration" submenu) of the BIOS. Refer to chapter 3 for more information.

Driver Installation

You may need to install the proper drivers in your operating system to use the USB device. Refer to chapter 4 for more information.

Wake-On-USB Keyboard/Mouse

The Wake-On-USB Keyboard/Mouse function allows you to use a USB keyboard or USB mouse to wake up a system from the S3 (STR - Suspend To RAM) state.



Important:

1. If you are using the Wake-On-USB Keyboard/Mouse function for 2 USB ports, the +5V_standby power source of your power supply must support $\geq 1.5A$. For 3 or more USB ports, the +5V_standby power source of your power supply must support $\geq 2A$.
2. When installing Windows 7, only native USB 2.0 devices (USB port 0 to USB port 3) can operate under DOS mode. Please refer to the following tables for more information on the type of USB ports.

I/O Connectors

Digital I/O Connector

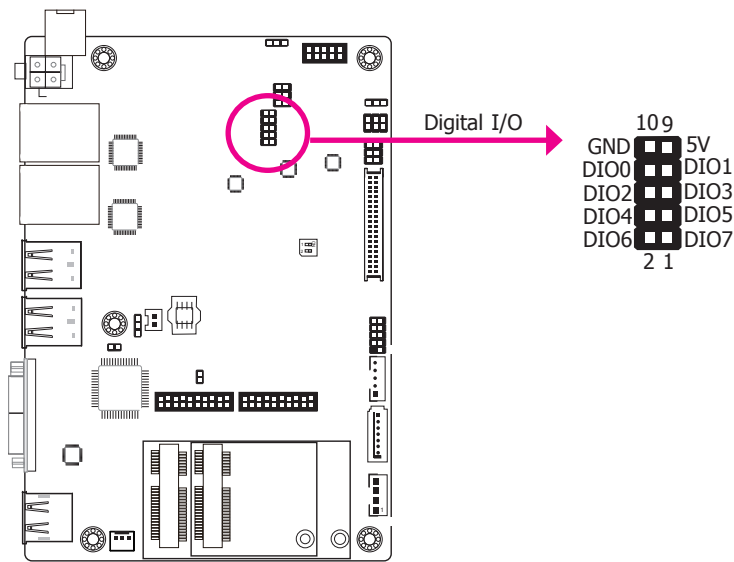

The 8-bit Digital I/O connector provides powering-on function to external devices that are connected to the connector.

Digital I/O Connector

Pins	Function
1	DIO7
2	DIO6
3	DIO5
4	DIO4
5	DIO3
6	DIO2
7	DIO1
8	DIO0
9	5V
10	GND

Front Audio Connector

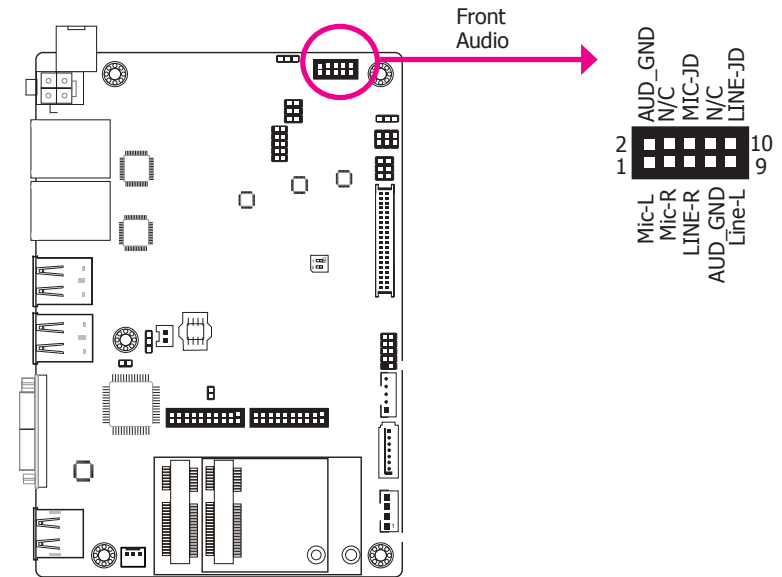

Front Audio

The front audio connector allows you to connect to the second line-out and mic-in jacks that are at the front panel of your system.

Driver Installation

Install the audio driver. Refer to the chapter 4 for more information.

COM (Serial) Ports

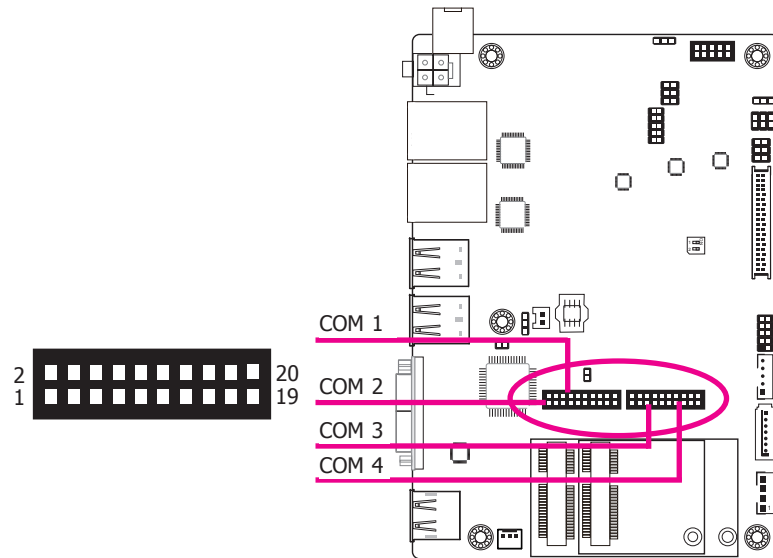

COM 1 and COM 2 are fixed at RS232/422/485. COM 3 and COM 4 are fixed at RS232.

The serial ports are asynchronous communication ports with 16C550A-compatible UARTs that can be used with modems, serial printers, remote display terminals, and other serial devices.

Connecting External Serial Ports

Your COM port may come mounted on a card-edge bracket. Install the card-edge bracket to an available slot at the rear of the system chassis then insert the serial port cable to the COM connector. Make sure the colored stripe on the ribbon cable is aligned with pin 1 of the COM connector.

BIOS Setting

Configure the serial COM ports in the Advanced menu ("Super IO Configuration" submenu) of the BIOS. Refer to the chapter 3 for more information.

COM Port Connector

Pins	RS-232	RS-422	RS-485
1	DCD_1	TD_1	RD_1
2	DSR_1	---	---
3	RD_1	DTR_1	DCD_1
4	RTS_1	---	---
5	TD_1	DCD_1	---
6	CTS_1	---	---
7	DTR_1	RD_1	---
8	RI_1	---	---
9	GND	GND	GND
10	GND	---	---
11	DCD_2	TD_2	RD_2
12	DSR_2	---	---
13	RD_2	DTR_2	DCD_2
14	RTS_2	---	---
15	TD_2	DCD_2	---
16	CTS_2	---	---
17	DTR_2	RD_2	---
18	RI_2	---	---
19	GND	GND	GND
20	GND	---	---

Standby Power LED

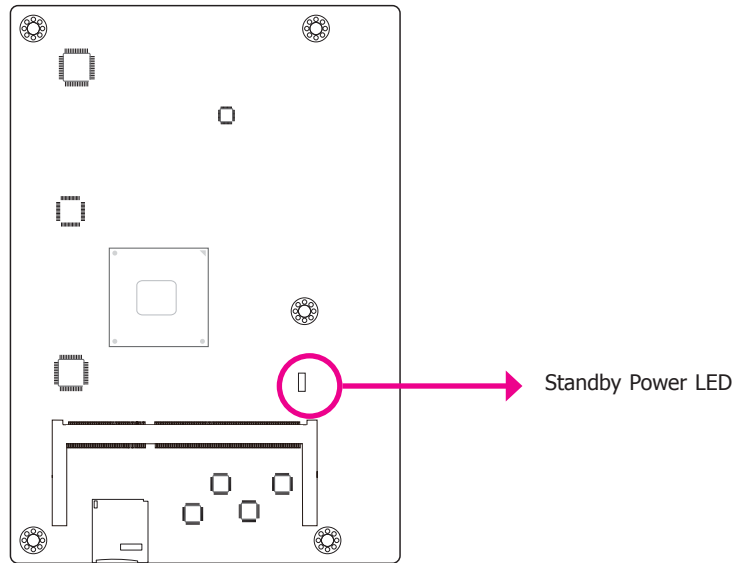

This LED will lit red when the system is in the standby mode. It indicates that there is power on the system board. Power-off the PC and then unplug the power cord prior to installing any devices. Failure to do so will cause severe damage to the motherboard and components.

Front Panel Connector

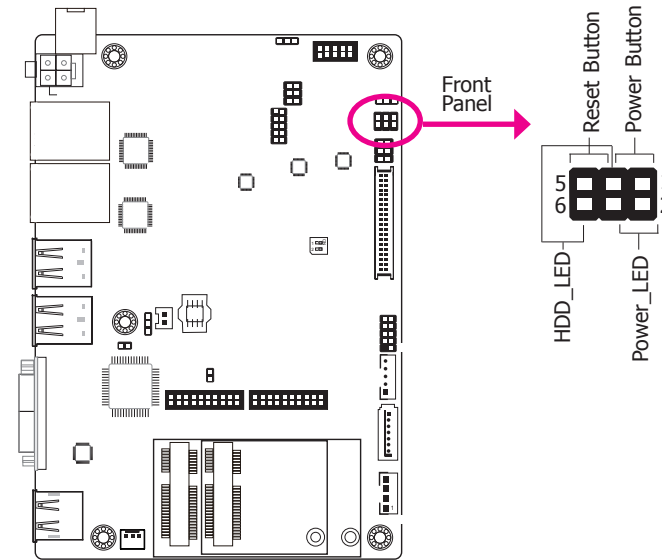

HDD-LED - HDD LED

This LED will light when the hard drive is being accessed.

RESET-SW - Reset Switch

This switch allows you to reboot without having to power off the system.

PWR-BTN - Power Switch

This switch is used to power on or off the system.

PWR-LED - Power/Standby LED

When the system's power is on, this LED will light. When the system is in the S1 (POS - Power On Suspend) state, it will blink every second. When the system is in the S3 (STR - Suspend To RAM) state, it will blink every 4 seconds.

	Pin	Pin Assignment		Pin	Pin Assignment
HDD-LED	6	HDD_LED	RESET-SW	5	Reset Button
	3	GND		3	GND
PWR-LED	4	SUS_LED	PWR-BTN	1	Power Button
	2	V_LED		3	GND

SATA (Serial ATA) Connector

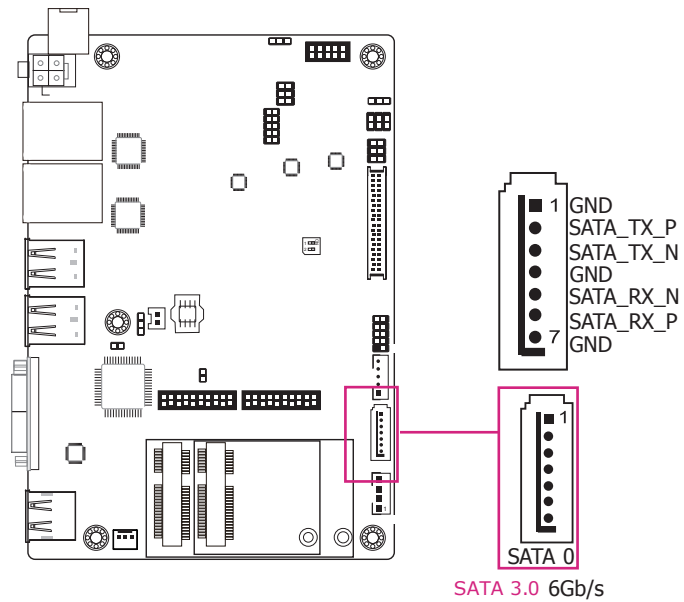

Features

- 1 Serial ATA 3.0 port with data transfer rate up to 6Gb/s
- Integrated Advanced Host Controller Interface (AHCI) controller

The Serial ATA connector is used to connect the Serial ATA device. Connect one end of the Serial ATA data cable to a SATA connector and the other end to your Serial ATA device.

BIOS Setting

Configure the Serial ATA drive in the Advanced menu ("SATA Configuration" submenu) of the BIOS. Refer to chapter 3 for more information.

SATA (Serial ATA) Power Connector

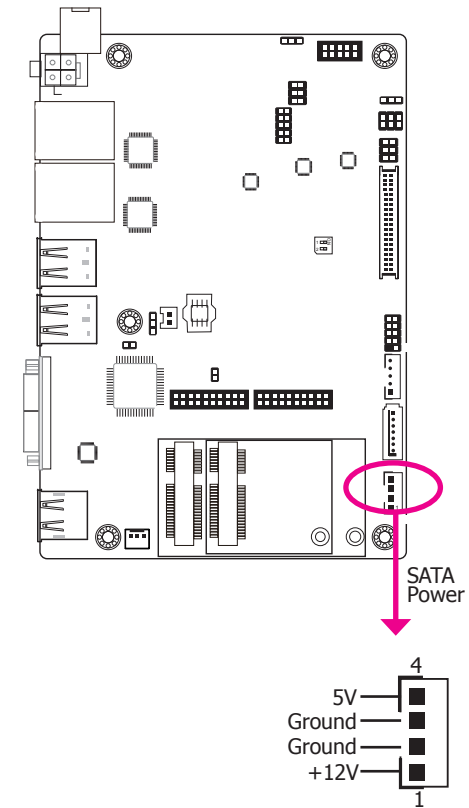

The SATA power connector supplies power to the SATA drive. Connect one end of the provided power cable to the SATA power connector and the other end to your storage device.

LVDS LCD Panel Connector LCD/Inverter Power Connector

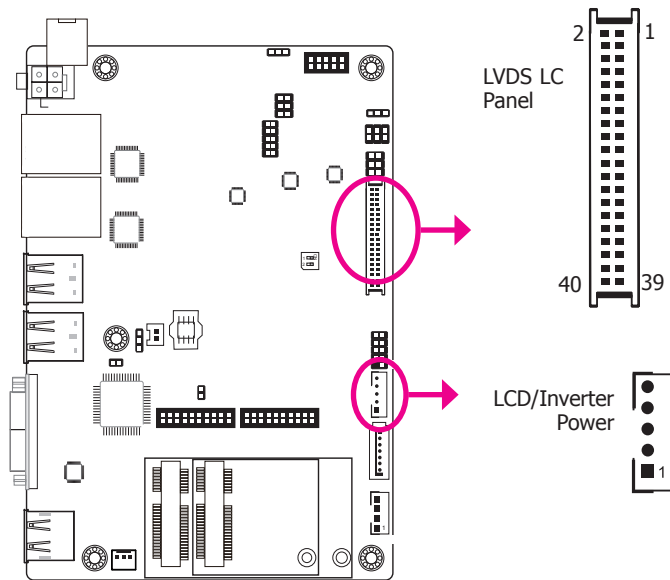

The system board allows you to connect a LCD Display Panel by means of the LVDS LCD panel connector and the LCD/Inverter power connector. These connectors transmit video signals and power from the system board to the LCD Display Panel.

Refer to the right side for the pin functions of these connectors.

BIOS Setting

Configure the LCD panel in the Advanced/Chipset Features submenu of the BIOS. Refer to chapter 3 for more information.



Note:

DFI board's LVDS connector: Hirose DF13-40DP-1.25V(91)/40P/1.25mm; cable side connector: Hirose DF13-40DS-1.25C.

LVDS LCD Panel Connector

Pins	Function	Pins	Function
1	GND	2	GND
3	LVDS_Out3+ (Odd_3+)	4	LVDS_Out7+ (Even_3+)
5	LVDS_Out3- (Odd_3-)	6	LVDS_Out7- (Even_3-)
7	GND	8	GND
9	LVDS_Out2+ (Odd_2+)	10	LVDS_Out6+ (Even_2+)
11	LVDS_Out2- (Odd_2-)	12	LVDS_Out6- (Even_2-)
13	GND	14	GND
15	LVDS_Out1+ (Odd_1+)	16	LVDS_Out5+ (Even_1+)
17	LVDS_Out1- (Odd_1-)	18	LVDS_Out5- (Even_1-)
19	GND	20	GND
21	LVDS_Out0+ (Odd_0+)	22	LVDS_Out4+ (Even_0+)
23	LVDS_Out0- (Odd_0-)	24	LVDS_Out4- (Even_0-)
25	GND	26	GND
27	LVDS_CLK1+ (Odd_CLK+)	28	LVDS_CLK2+ (Even_CLK+)
29	LVDS_CLK1- (Odd_CLK-)	30	LVDS_CLK2- (Even_CLK-)
31	GND	32	GND
33	DDC_CLK	34	N.C.
35	DDC_DATA	36	N.C.
37	Panel Power	38	Panel Power
39	Panel Power	40	Panel Power

LCD/Inverter Power Connector

Pins	Function
1	+12V
2	GND
3	Panel Backlight On/Off Control
4	Dimming Control
5	+5V

Expansion Slot

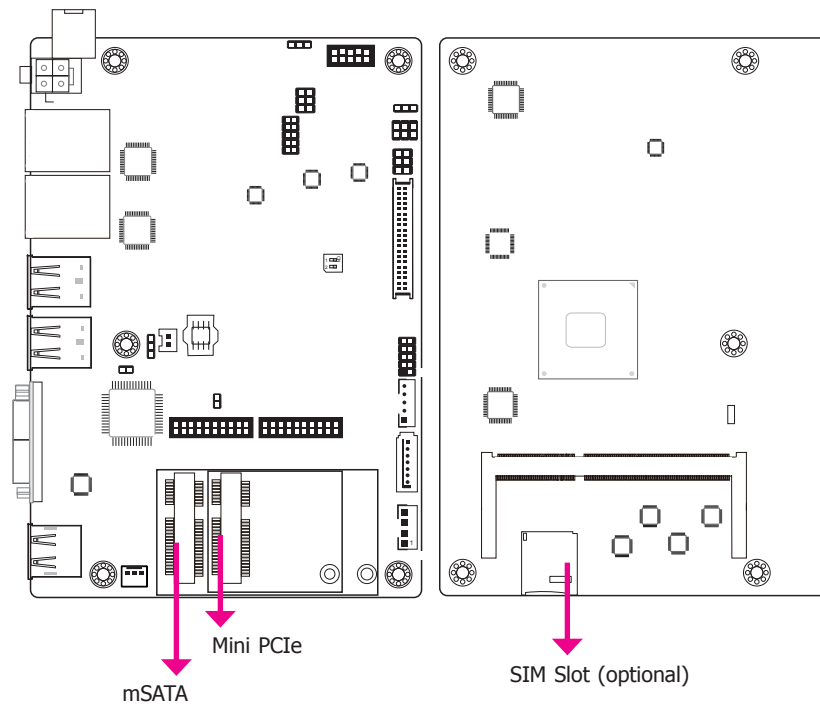

Mini PCI Express Slot

The Mini PCIe socket is used to install a Mini PCIe card. Mini PCIe card is a small form factor PCI card with the same signal protocol, electrical definitions, and configuration definitions as the conventional PCI.

SIM Slot (optional)

The SIM slot on the system board is used to insert a SIM card.

Cooling Fan Connector

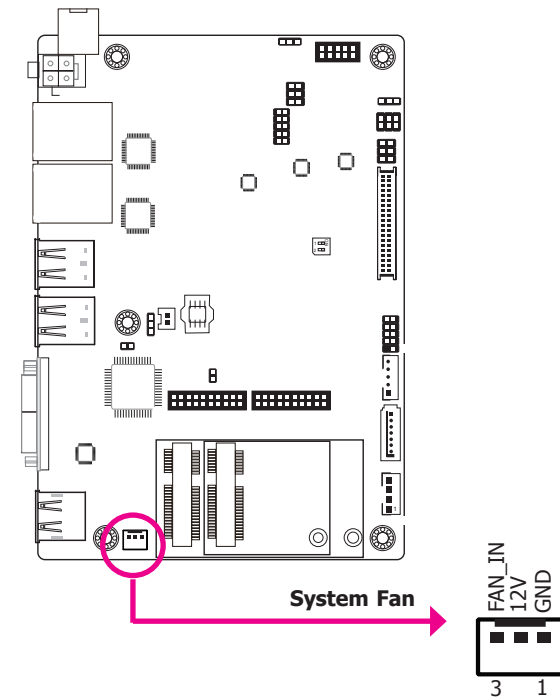

The fan connector is used to connect the cooling fan. The cooling fan will provide adequate airflow throughout the chassis to prevent overheating the CPU and system board components.

BIOS Setting

The Advanced menu ("NCT6106D HW Monitor" submenu) of the BIOS will display the current speed of the cooling fans. Refer to chapter 3 for more information.

SMBus Connector

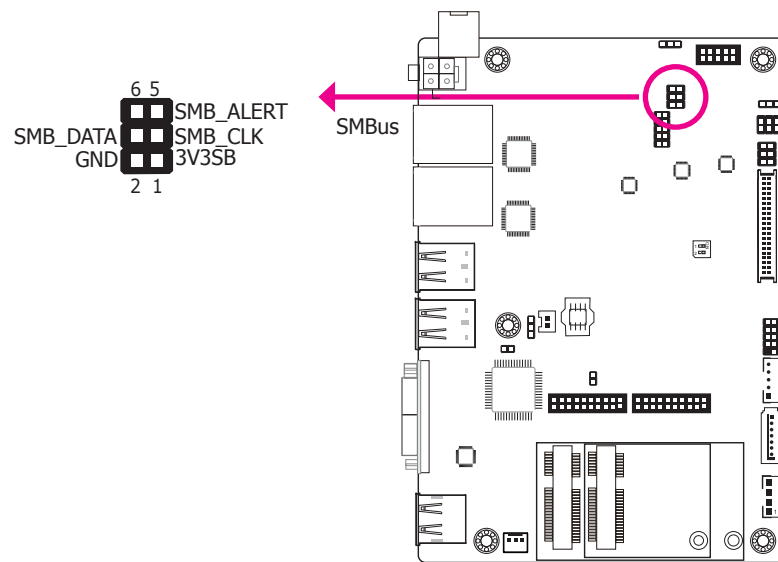

The SMBus (System Management Bus) connector is used to connect SMBus devices. It is a multiple device bus that allows multiple chips to connect to the same bus and enable each one to act as a master by initiating data transfer.

Chassis Intrusion Connector

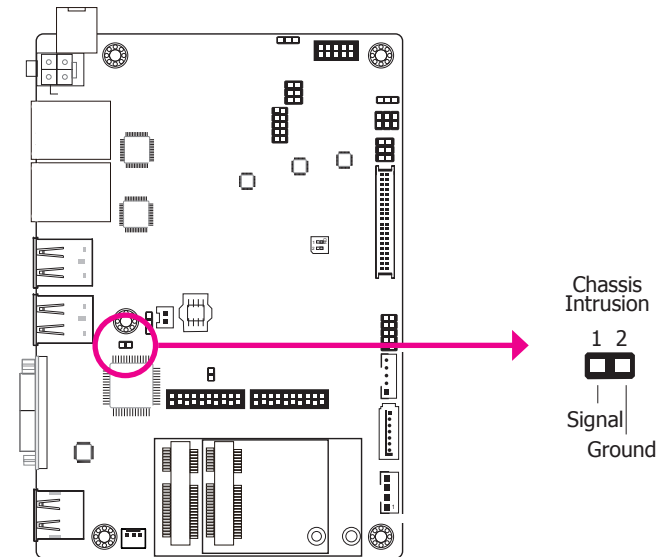

The board supports the chassis intrusion detection function. Connect the chassis intrusion sensor cable from the chassis to this connector. When the system's power is on and a chassis intrusion occurred, an alarm will sound. When the system's power is off and a chassis intrusion occurred, the alarm will sound only when the system restarts.

Battery

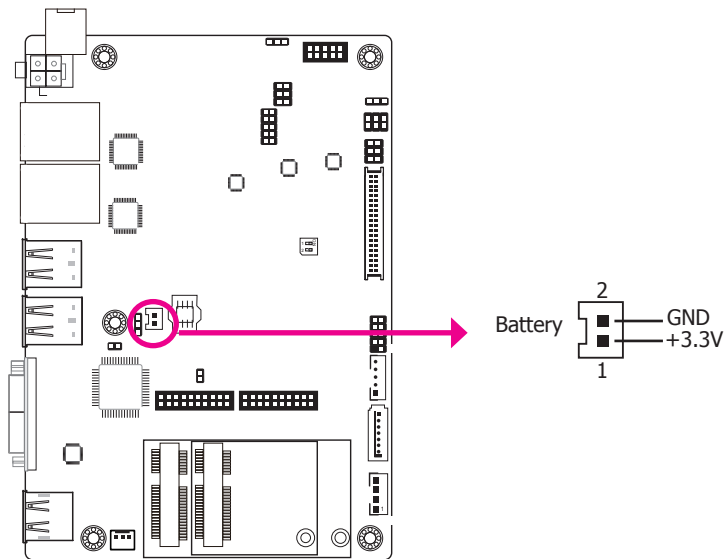

The lithium ion battery powers the real-time clock and CMOS memory. It is an auxiliary source of power when the main power is shut off.

Safety Measures

- Danger of explosion if battery incorrectly replaced.
- Replace only with the same or equivalent type recommend by the manufacturer.
- Dispose of used batteries according to local ordinance.

Chapter 3 - BIOS Setup

Overview

The BIOS is a program that takes care of the basic level of communication between the CPU and peripherals. It contains codes for various advanced features found in this system board. The BIOS allows you to configure the system and save the configuration in a battery-backed CMOS so that the data retains even when the power is off. In general, the information stored in the CMOS RAM of the EEPROM will stay unchanged unless a configuration change has been made such as a hard drive replaced or a device added.

It is possible that the CMOS battery will fail causing CMOS data loss. If this happens, you need to install a new CMOS battery and reconfigure the BIOS settings.



Note:

The BIOS is constantly updated to improve the performance of the system board; therefore the BIOS screens in this chapter may not appear the same as the actual one. These screens are for reference purpose only.

Default Configuration

Most of the configuration settings are either predefined according to the Load Optimal Defaults settings which are stored in the BIOS or are automatically detected and configured without requiring any actions. There are a few settings that you may need to change depending on your system configuration.

Entering the BIOS Setup Utility

The BIOS Setup Utility can only be operated from the keyboard and all commands are keyboard commands. The commands are available at the right side of each setup screen.

The BIOS Setup Utility does not require an operating system to run. After you power up the system, the BIOS message appears on the screen and the memory count begins. After the memory test, the message "Press DEL to run setup" will appear on the screen. If the message disappears before you respond, restart the system or press the "Reset" button. You may also restart the system by pressing the <Ctrl> <Alt> and keys simultaneously.

Legends

Keys	Function
Right and Left arrows	Moves the highlight left or right to select a menu.
Up and Down arrows	Moves the highlight up or down between submenu or fields.
<Esc>	Exit to the BIOS Setup Utility.
+ (plus key)	Scrolls forward through the values or options of the highlighted field.
- (minus key)	Scrolls backward through the values or options of the highlighted field.
Tab	Select a field.
<F1>	Displays general help
<F2>	Previous values
<F3>	Optimized defaults
<F4>	Saves and resets the setup program.
<Enter>	Press <Enter> to enter the highlighted submenu.

Scroll Bar

When a scroll bar appears to the right of the setup screen, it indicates that there are more available fields not shown on the screen. Use the up and down arrow keys to scroll through all the available fields.

Submenu

When "►" appears on the left of a particular field, it indicates that a submenu which contains additional options are available for that field. To display the submenu, move the highlight to that field and press <Enter>.

Insyde BIOS Setup Utility

Main

The Main menu is the first screen that you will see when you enter the BIOS Setup Utility.

InsydeH20 Setup Utility		Rev. 5.0
Main	Advanced	Security Boot Exit
Project Name	BW551 X64	This is the help for the hour, minute, second field. Valid range is from 0 to 23; 0 to 59, 0 to 59. INCREASE/REDUCE: +/-.
BIOS Version	64.26A	
Processor Type	Intel(R) Celeron(R) CPU N3060 @ 1.60GHz	
CPU Speed	1600MHz	
CPUID	000406C4h	
L1 Data Cache	24 KB	
L1 Instruction Cache	32 KB	
L2 RAN	1024 KB	
L3 Cache	0 KB	
Number of Processors	Core 2	
Microcode Revision	40A	
Total Memory	4096 MB	
System Memory Speed	1600 MHz	
SODIMM 0	4096 MB	
TXE FW Version	2.0.2.2092	
System Time	[21:12:02]	
System Date	[15/4/2016]	

F1 Help	↑/↓ Select Item	F5/F6 Change Values	F9 Setup Defaults
Esc Exit	←/→ Select Item	Enter Select ► SubMenu	F10 Save and Exit

System Date

The date format is <day>, <month>, <date>, <year>. Day displays a day, from Sunday to Saturday. Month displays the month, from January to December. Date displays the date, from 1 to 31. Year displays the year, from 1980 to 2099.

System Time

The time format is <hour>, <minute>, <second>. The time is based on the 24-hour military-time clock. For example, 1 p.m. is 13:00:00. Hour displays hours from 00 to 23. Minute displays minutes from 00 to 59. Second displays seconds from 00 to 59.

Advanced

The Advanced menu allows you to configure your system for basic operation. Some entries are defaults required by the system board, while others, if enabled, will improve the performance of your system or let you set some features according to your preference.



Important:

Setting incorrect field values may cause the system to malfunction.

InsydeH20 Setup Utility		Rev. 5.0
Main	Advanced	Security Boot Exit
▶ ACPI Configuration		Configures ACPI Tables. Features setting
▶ CPU Configuration		
▶ Video Configuration		
▶ Audio Configuration		
▶ SATA Configuration		
▶ USB Configuration		
▶ PCI Express Configuration		
▶ ME Configuration		
▶ SIO NUVOTON6106D		

F1 Help	↑/↓ Select Item	F5/F6 Change Values	F9 Setup Defaults
Esc Exit	←/→ Select Item	Enter Select ► SubMenu	F10 Save and Exit

ACPI Settings

This section is used to configure the system ACPI parameters.

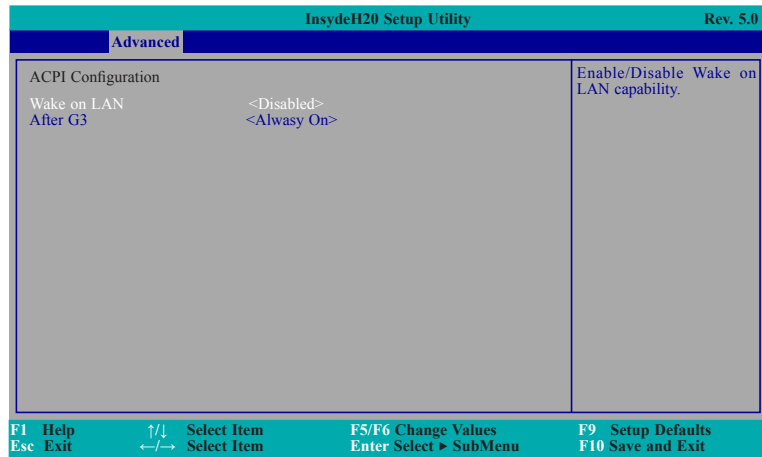

Wake on LAN

This field use to enable or disable the LAN signal to wake up the system.

After G3

This field is to specify what state to go when power is re-applied after a power failue (G3 state).

Always On The system working state.

Always Off Off, except for trickle current to devices such as the power button.

CPU Configuration

This section is used to configure the CPU.

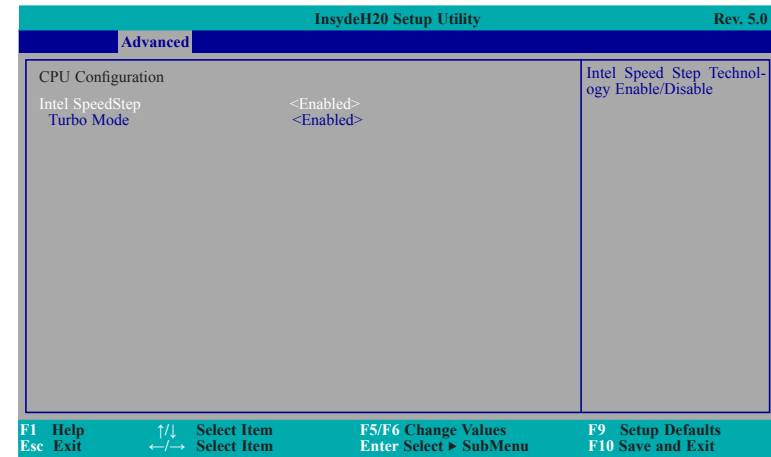

Intel(R) SpeedStep(tm)

This field is used to enable or disable the Intel Enhanced SpeedStep Technology.

Turbo Mode

Enable or disable the turbo mode.

Video Configuration

This section configures the video settings.

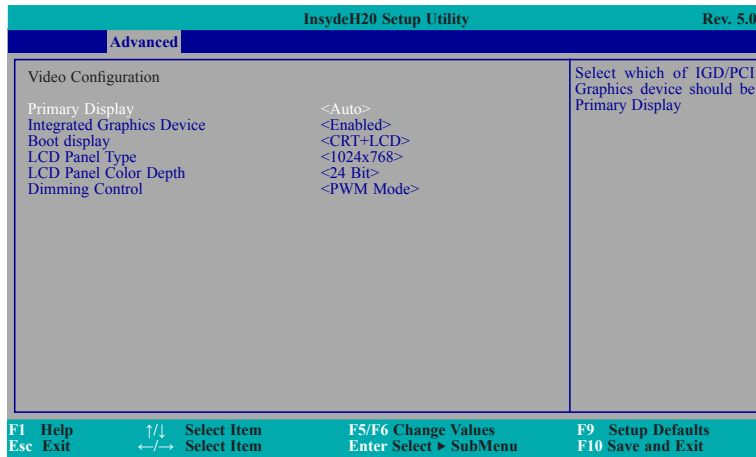

Primary Display

Select which of IGD/PCI Graphics device should be Primary Display

Integrated Graphics Device

Enable or disable the IGD function.

Boot display

Set the display device combination.

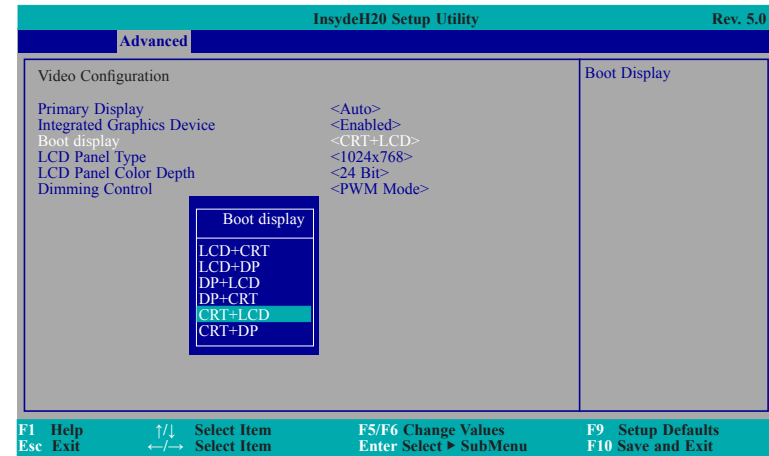

LCD Panel Type

Select the LCD panel type.



LCD Panel Color Depth

Select the LCD panel color depth: 18 bit, 24 bit, 36 bit, and 48 bit.

Dimming Control

Select Dimming Type PWM/DC mode for LCD.

Audio Configuration

This section is used to configure the audio settings.

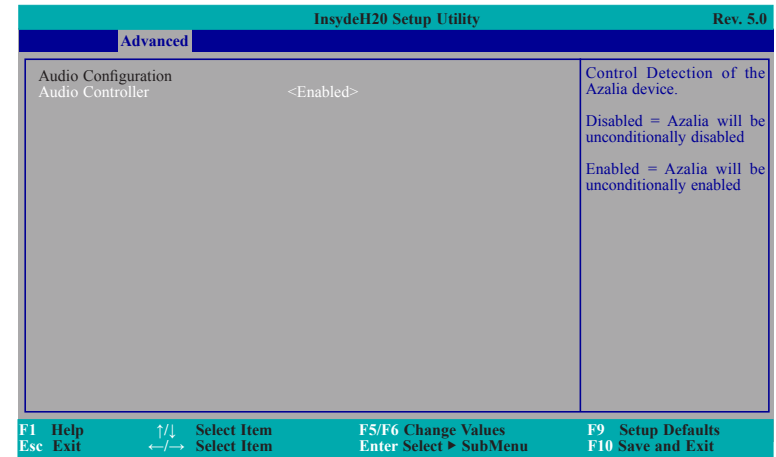
**Audio Controller**

Control the detection of the Azalia device.

Disabled

Azalia will be unconditionally disabled.

Enabled

Azalia will be unconditionally enabled.

SATA Configuration

This section is designed to select the SATA controller and the type of hard disk drive which are installed in your system unit.

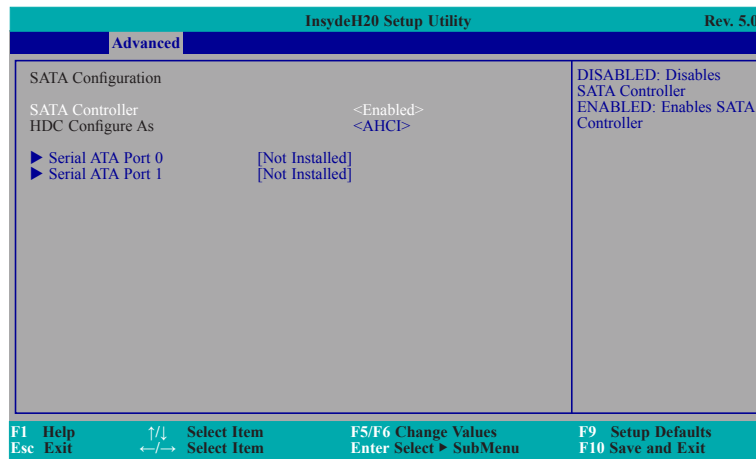

SATA Controller

This field is used to enable or disable Serial ATA devices.

HDC Configures As

The mode selection determines how the SATA controller(s) operates.

AHCI Mode

This option allows the Serial ATA devices to use AHCI (Advanced Host Controller Interface).

Serial ATA Port 0, and 1

This field is used to enable or disable the serial ATA port.

USB Configuration

This section is used to configure the parameters of the USB device.

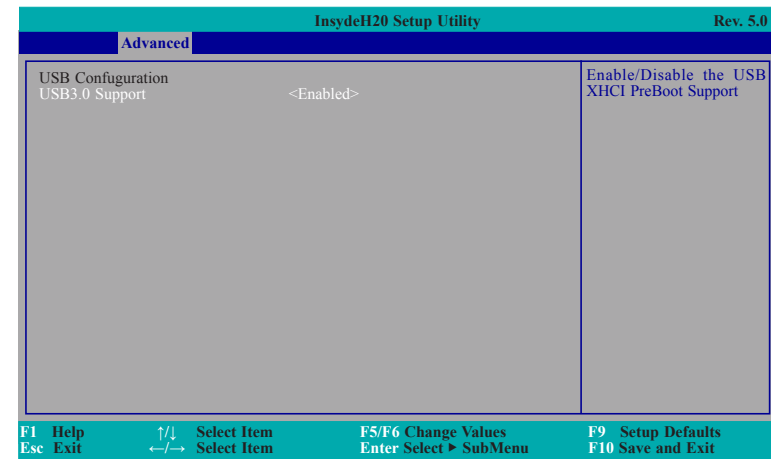

USB3.0 Support

Disabled

Disable USB XHCI PreBoot Support.

Enabled

Enable USB XHCI PreBoot Support.

PCI Express Configuration

This section configures settings relevant to PCI Express root ports.

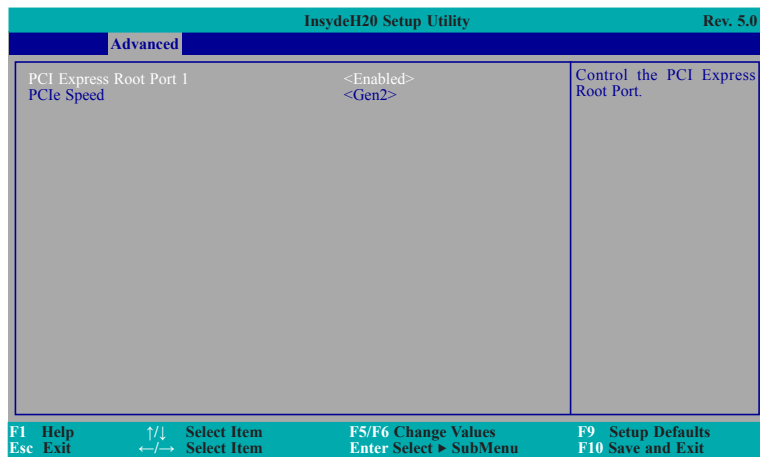
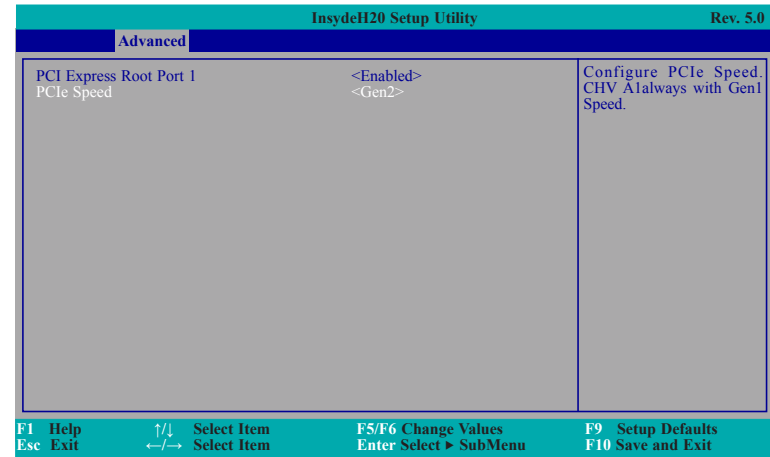
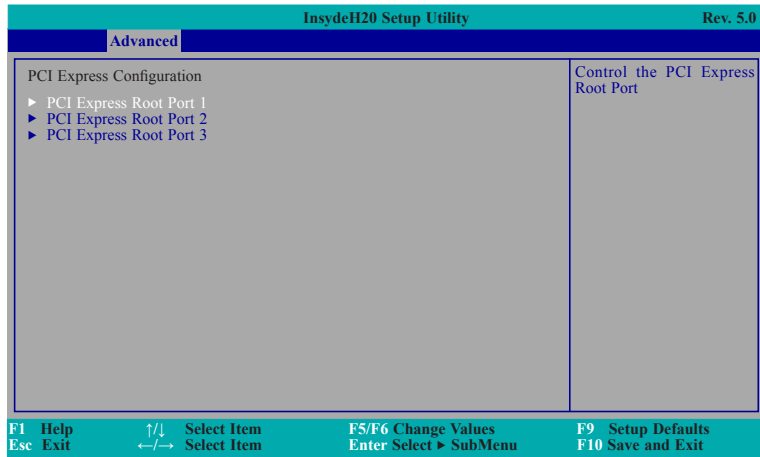

PCI Express Root Port

This field is used to enable or disable the PCI Express Root Port.

PCIe Speed

Select the speed of the PCI Express Root Port: Gen1 or Gen2.

ME Configuration

This section configures settings relevant to flash ME region.

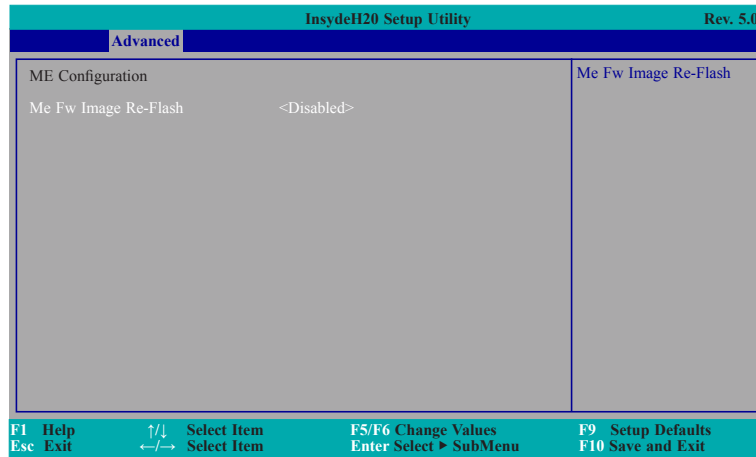

Me Fw Image Re-Flash

This field is used to enable or disable the flash ME region.

SIO NUVOTON6106D

This section configures the system super I/O chip parameters.

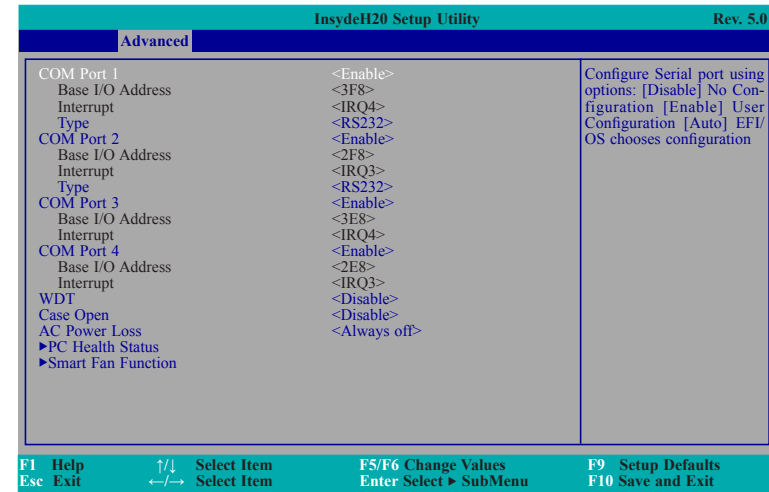

Serial Port 1 to Serial Port 4

Configure the settings to use the serial port.

Disable No configuration

Enable User configuration

Type

Choose RS232/RS422/RS485 (Peer-to-Peer) for the serial port type.

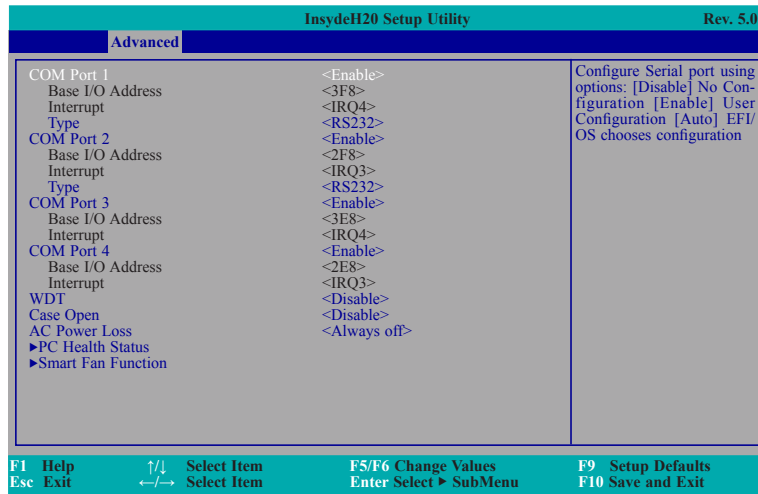

WDT

Enable or disable the watchdog function.

Case Open

Enable or disable the case open.

AC Power Loss

Set the AC power loss always off/on.

PC Health Status

This field only displays the PC health status.

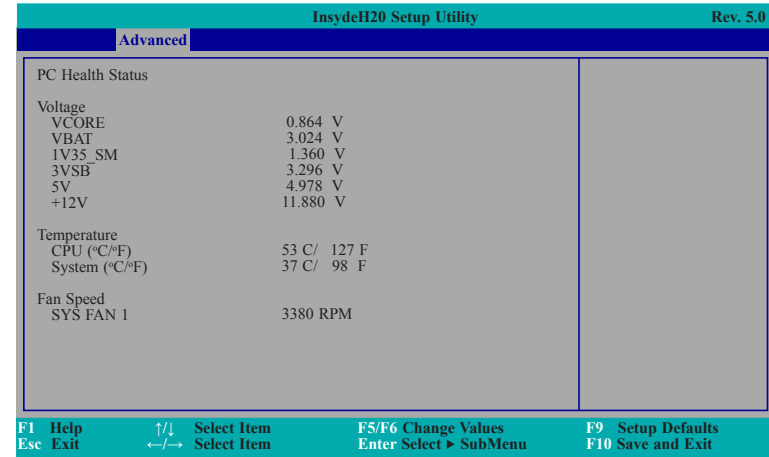

Smart Fan Function

This section configures the Smart Fan Function.

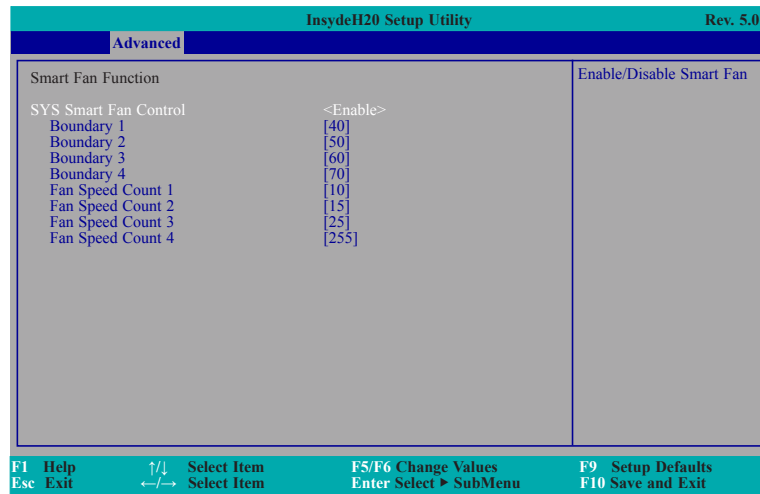

SYS Smart Fan Control

Enable or disable the smart fan.

Boundary 1 to Boundary 4

Set the boundary temperature. The range is from 0-127°C.

Fan Speed Count 1 to Fan Speed Count 4

Set the fan speed. The range is from 0-100%.

Security

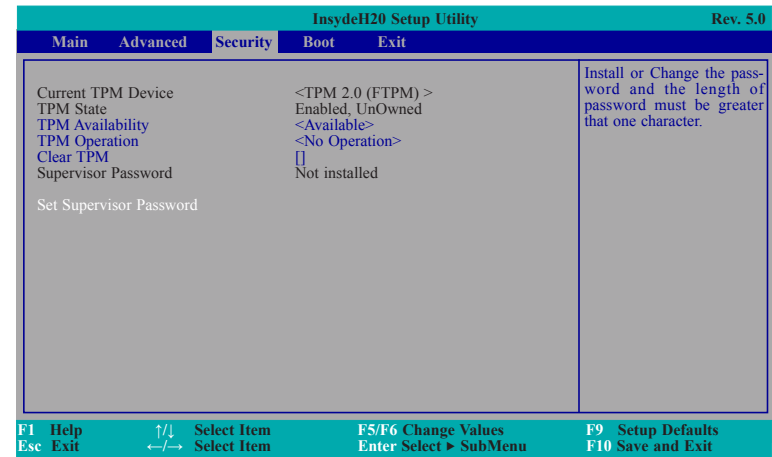

TPM Availability

When Hidden, don't exposes TPM to 0

TPM Operation

Enable: Enable Storage and Endorsement Hierarchy.

Disable: Disable Storage and Endorsement Hierarchy.

Clear TPM

Removes all TPM context associated with a specific Owner.

Set Supervisor Password

Set the supervisor's password and the length of the password must be greater than one character.

Boot

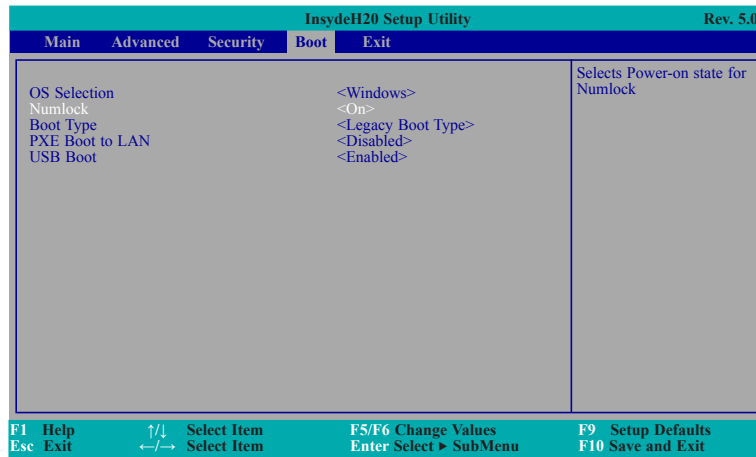

OS Selection

Select Windows/Linux/DOS for OS Selection.

Numlock

Select the power-on state for numlock.

Boot Type

Select the boot type. The options are Dual Boot Type, Legacy Boot Type or UEFI Boot Type.

PXE Boot Capability

Disables or enables PXE boot to LAN.

USB Boot

Enable or disable the booting to USB boot devices.

Exit

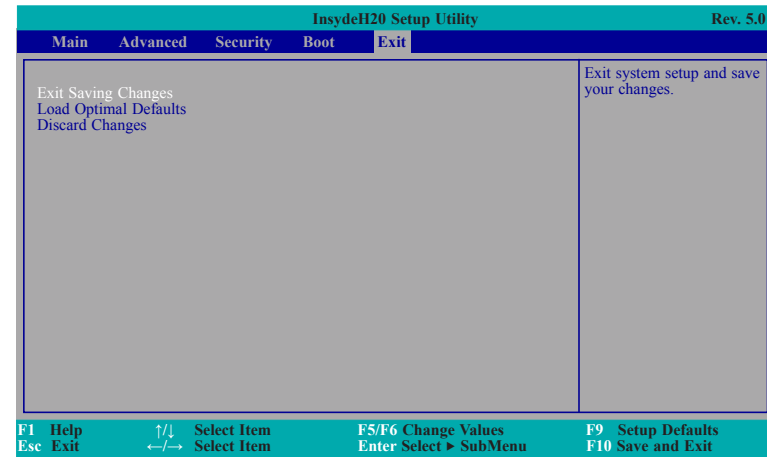

Exit Saving Changes

Select this field and then press <Enter> to exit the system setup and save your changes.

Load Optimal Defaults

Select this field and then press <Enter> to load optimal defaults.

Discard Changes

Select this field and then press <Enter> to exit the system setup without saving your changes.

Updating the BIOS

To update the BIOS, you will need the new BIOS file and a flash utility. Please contact technical support or your sales representative for the files and specific instructions about how to update BIOS with the flash utility.

When you download the given BIOS file, you may find a BIOS flash utility attached with the BIOS file. This is the utility for performing BIOS updating procedure. For your convenience, we will also provide you with an auto-execution file in the BIOS file downloaded. This auto-execution file will bring you directly to the flash utility menu soon after system boots up and finishes running the boot files in your boot disk.

```

Read file successfully. (path= "platform.ini")

Information
Please do not remove the AC power

Insyde H20FFT (Flash Firmware Tool) Version (SEG) 100.00.08.10
Copyright(c) 2012 - 2016, Insyde Software Corp. All Rights Reserved.

Initializing
Current BIOS Model name: BW551
New BIOS Model name: BW551

Current BIOS version: 65.05A
New BIOS version: 65.05A

Updating Block at FFFFF000h
0%      25%      50%      75%      100%
|-----|-----|-----|-----|
C:\BW551>_

```

Notice: BIOS SPI ROM

1. The Intel® Management Engine has already been integrated into this system board. Due to the safety concerns, the BIOS (SPI ROM) chip cannot be removed from this system board and used on another system board of the same model.
2. The BIOS (SPI ROM) on this system board must be the original equipment from the factory and cannot be used to replace one which has been utilized on other system boards.
3. If you do not follow the methods above, the Intel® Management Engine will not be updated and will cease to be effective.



Note:

- a. You can take advantage of flash tools to update the default configuration of the BIOS (SPI ROM) to the latest version anytime.
- b. When the BIOS IC needs to be replaced, you have to populate it properly onto the system board after the EEPROM programmer has been burned and follow the technical person's instructions to confirm that the MAC address should be burned or not.

Chapter 4 - Supported Software

The DVD that came with the system board contains drivers, utilities and software applications required to enhance the performance of the system board.

Insert the DVD into a DVD-ROM drive. The autorun screen (Mainboard Utility DVD) will appear. If after inserting the DVD, "Autorun" did not automatically start (which is, the Mainboard Utility DVD screen did not appear), please go directly to the root directory of the DVD and double-click "Setup".

For Windows 10

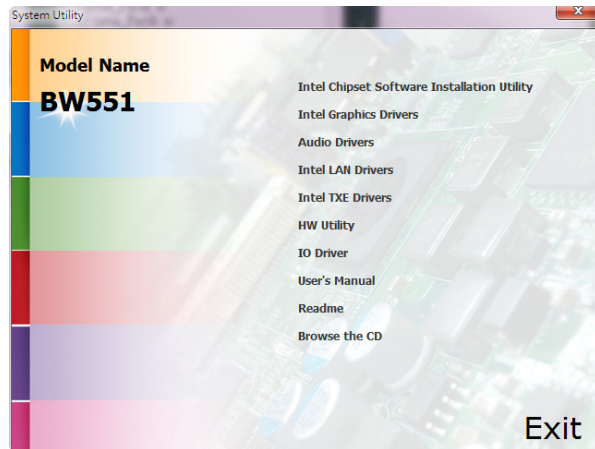

For Windows 8.1

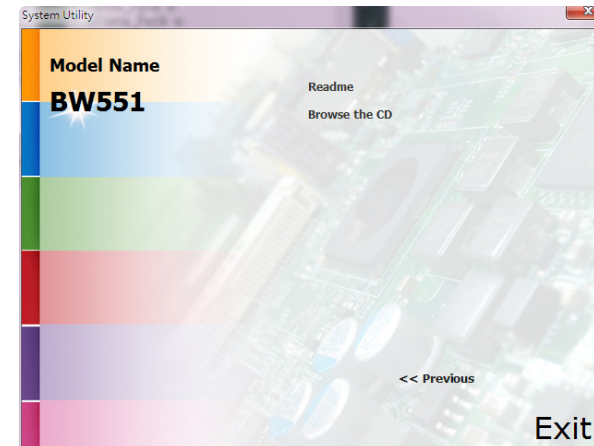

For Windows 7

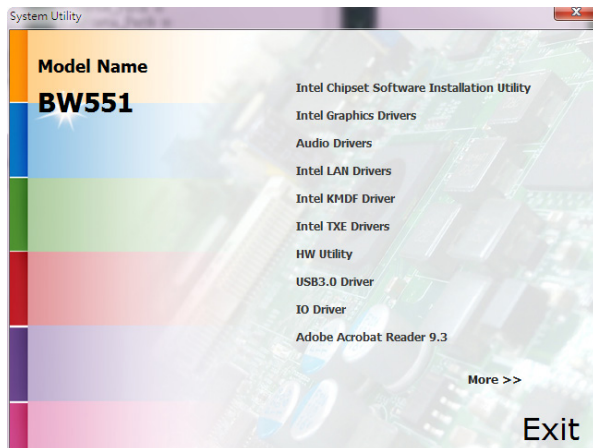

Intel Chipset Software Installation Utility

The Intel Chipset Software Installation Utility is used for updating Windows® INF files so that the Intel chipset can be recognized and configured properly in the system.

To install the utility, click "Intel Chipset Software Installation Utility" on the main menu.

1. Setup is ready to install the utility. Click Next.



2. Read the license agreement then click Yes.



- Go through the readme document for more installation tips then click Next.

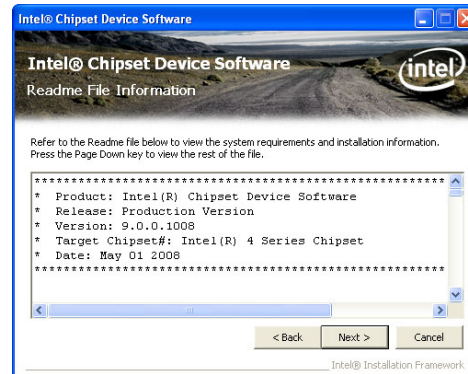

- Click Finish to exit setup.



Intel Graphics Drivers

To install the driver, click "Intel Graphics Drivers" on the main menu.

- Setup is now ready to install the graphics driver. Click Next.



By default, the "Automatically run WinSAT and enable the Windows Aero desktop theme" is enabled. With this enabled, after installing the graphics driver and the system rebooted, the screen will turn blank for 1 to 2 minutes (while WinSAT is running) before the Windows 7/Windows 8.1/Windows 10 desktop appears. The "blank screen" period is the time Windows is testing the graphics performance.

- Read the license agreement then click Yes.

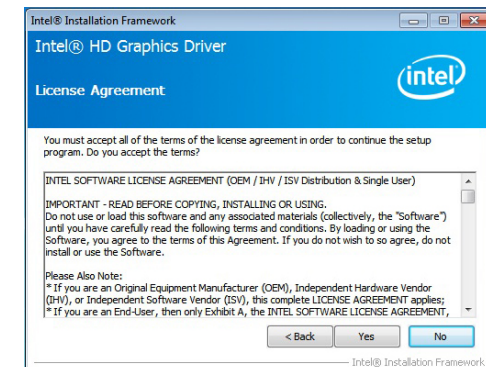

- Go through the readme document for system requirements and installation tips then click Next.

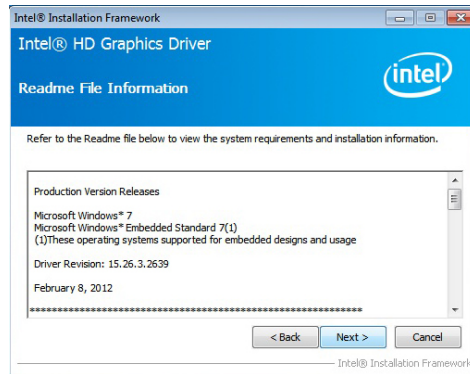

- Setup is now installing the driver. Click Next to continue.

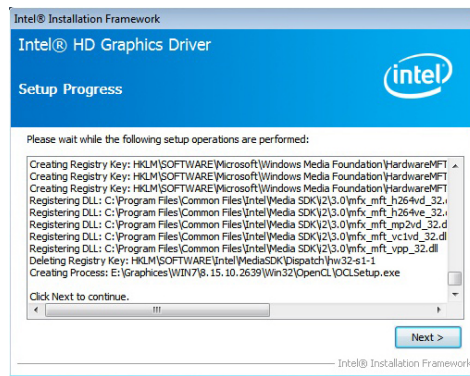

- Click "Yes, I want to restart this computer now" then click Finish.

Restarting the system will allow the new software installation to take effect.



Audio Drivers

To install the driver, click "Audio Drivers" on the main menu.

- Setup is ready to install the driver. Click Next.

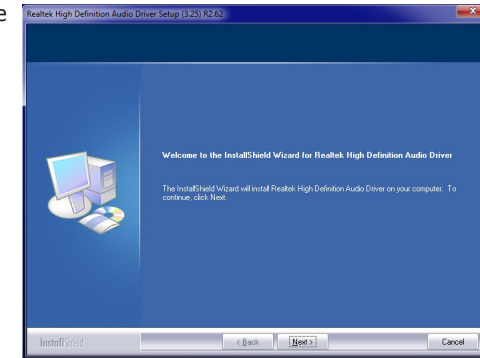

- Click "Yes, I want to restart my computer now" then click Finish.

Restarting the system will allow the new software installation to take effect.

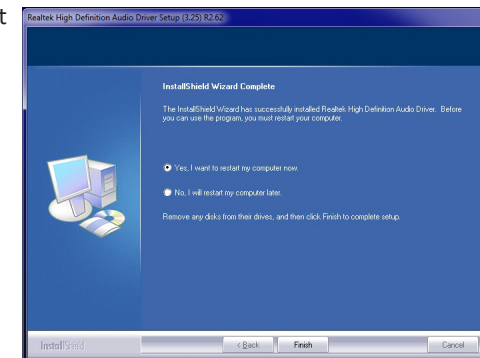

Intel LAN Drivers

To install the driver, click "Intel LAN Drivers" on the main menu.

1. Setup is ready to install the driver. Click Next.



2. Click "I accept the terms in the license agreement" then click "Next".

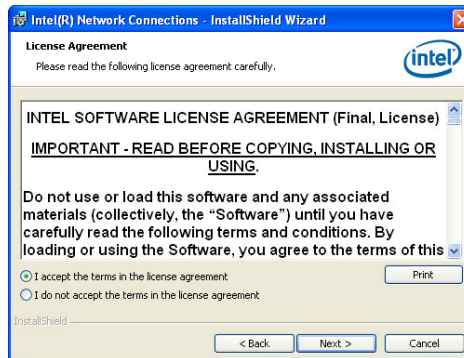

3. Select the program features you want installed then click Next.

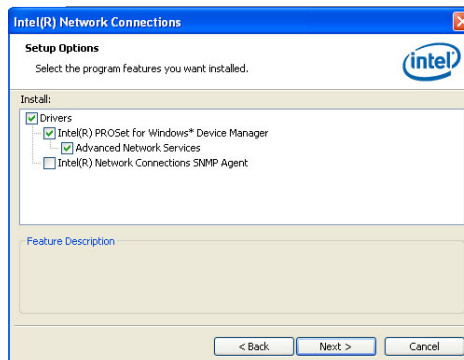

4. Click Install to begin the installation.

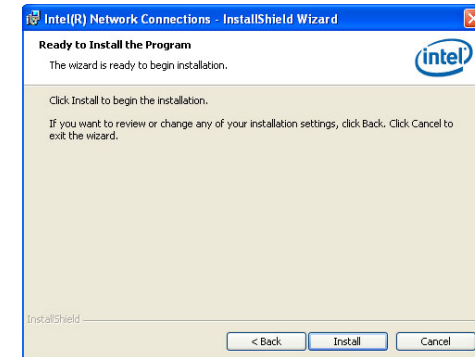

5. After completing installation, click Finish.

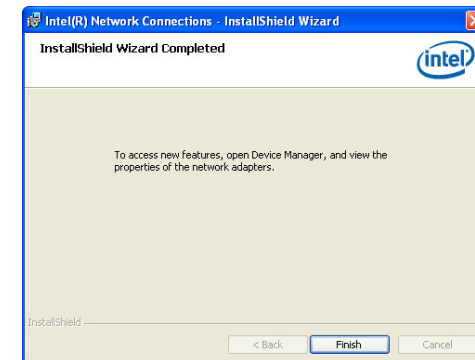

Kernel Mode Driver Framework (For Windows 7 only)

To install the driver, click "Kernel Mode Driver Framework" on the main menu.

1. Click "Yes" to install the update.

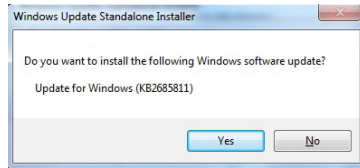

2. The update is installed now.

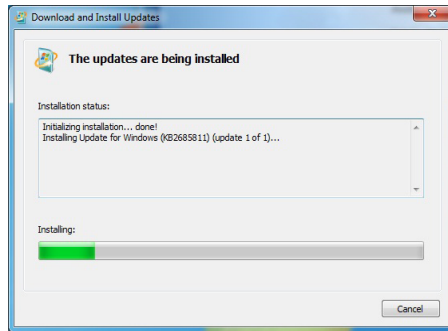

3. Click "Restart Now" to restart your computer when the installation is complete.

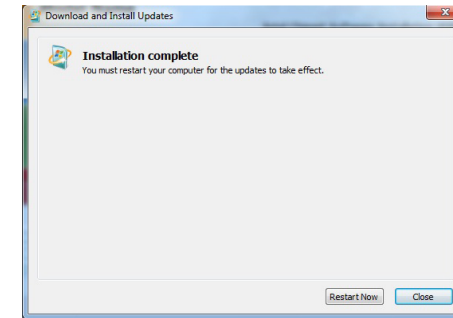

Intel Trusted Execution Engine Driver

To install the driver, click "Intel Trusted Execution Engine Driver" on the main menu.

1. Tick "I accept the terms in the License Agreement" and then click "Next."

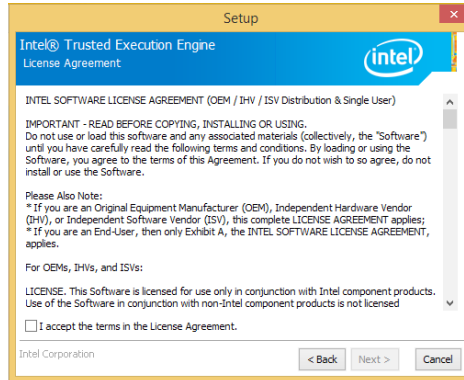

2. The step shows the components which will be installed. Then, Click Next.

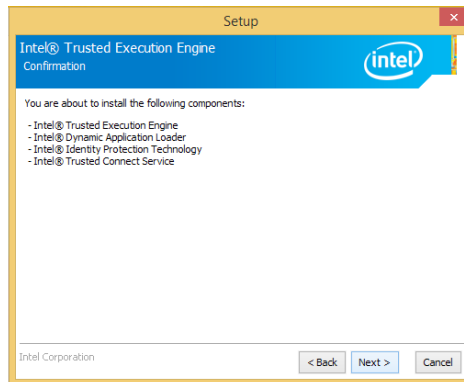

3. The step displays the installing status in the progress.

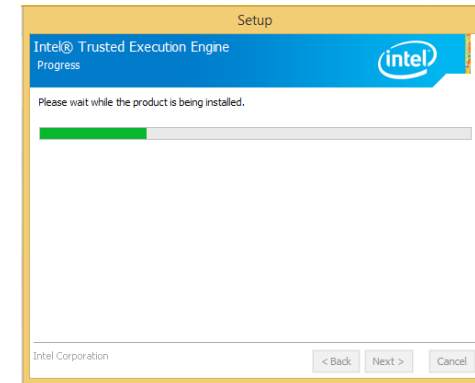

4. Click "Finish" when the installation is complete.

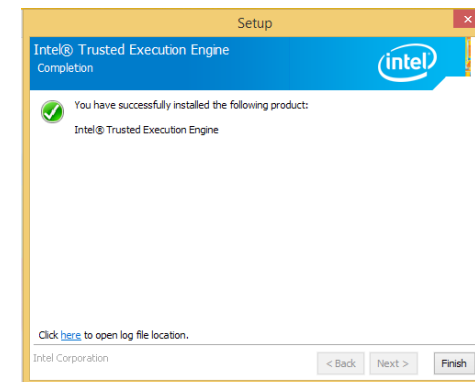

HW Utility

HW Utility provides information about the board, Watchdog, and DIO. To access the utility, click "HW Utility" on the main menu.



Note:

If you are using Windows 7 or later versions, you need to access the operating system as an administrator to be able to install the utility.

1. Setup is ready to install the driver.

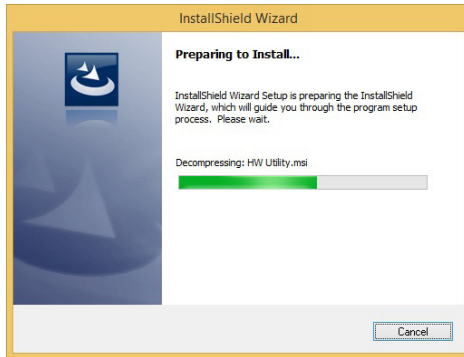

2. Click "Next" to continue.

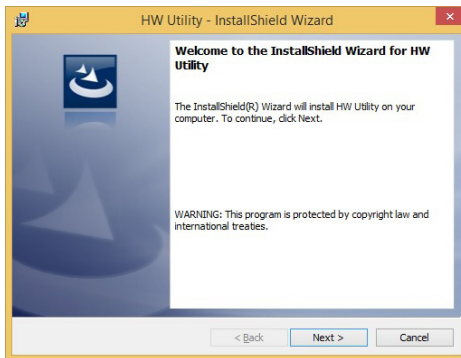

3. Read the license agreement then click "I accept the terms in the license agreement". Click "Next".

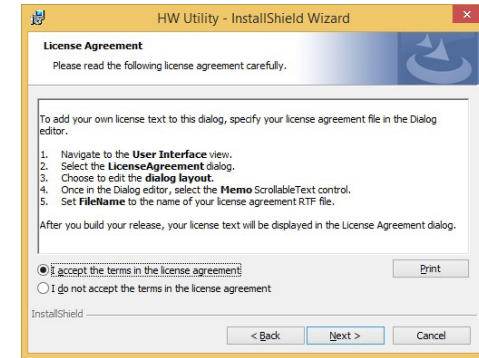

4. The wizard is ready to begin installation. Click "Install".

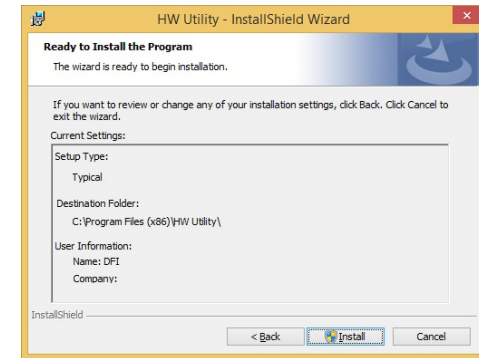

5. Please wait while the program features are being installed.

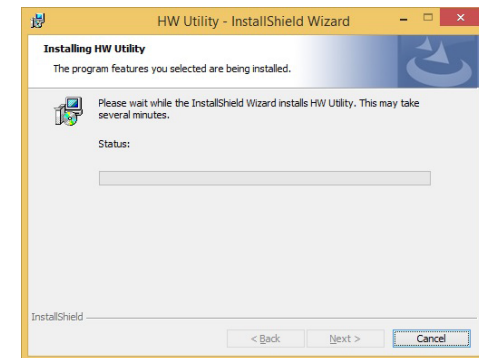

- After completing installation, click "Finish".



The HW Utility icon will appear on the desktop. Double-click the icon to open the utility.

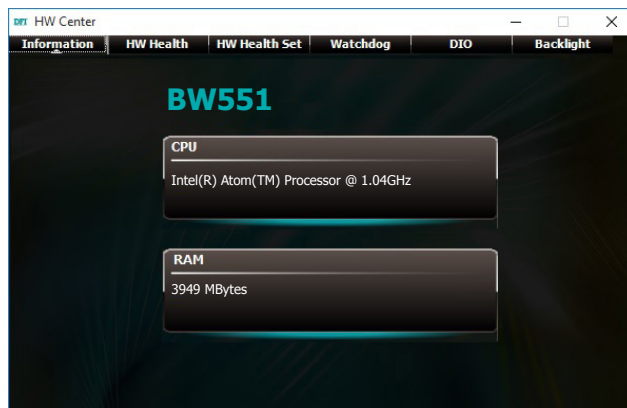

Information



Note: The screenshot displayed above is for illustrative purpose only, and may not resemble the actual screen.

The BW551 HW Utility features the following tabs: Information, HW Health, HW Health set, Watchdog, DIO and Backlight. Click on the tabs to access information about the board.

Intel USB 3.0 Drivers (For Windows 7 and Windows 8.1)

To install the driver, click "Intel USB 3.0 Driver" on the main menu.

- Setup is ready to install the driver. Click Next.

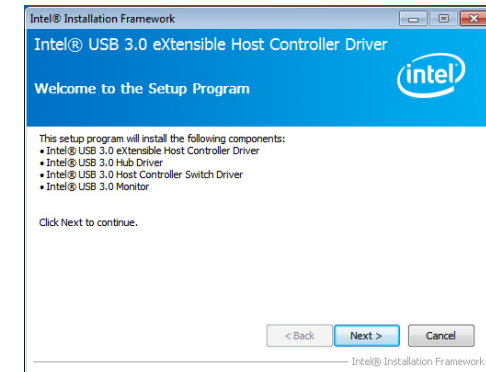

- Read the license agreement then click Yes.

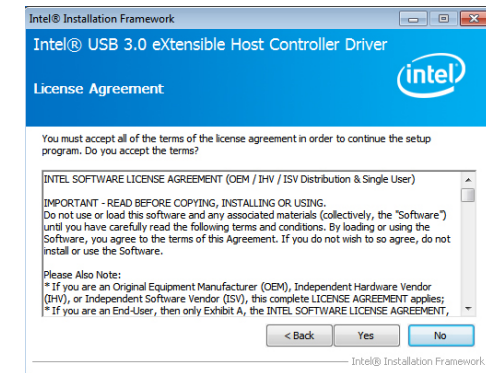

3. Go through the readme document for more installation tips then click Next.

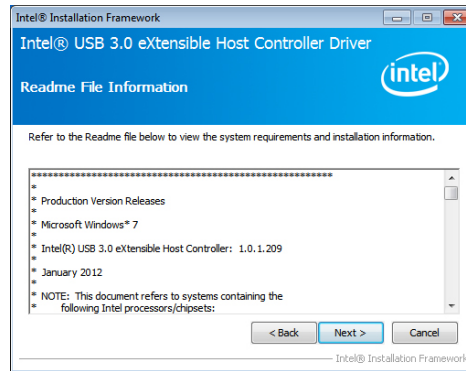

4. Setup is currently installing the driver. After installation has completed, click Next.

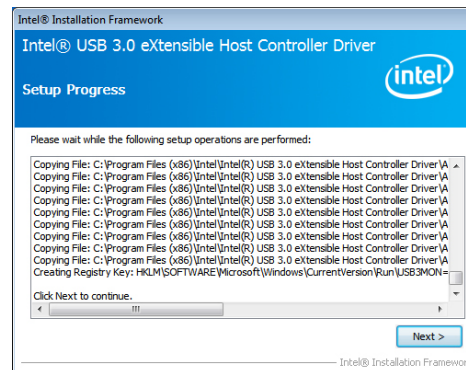

5. After completing installation, click Finish.



IO Driver

To install the driver, click "Intel Serial IO Driver" on the main menu

1. Setup is ready to install the driver. Click Next.

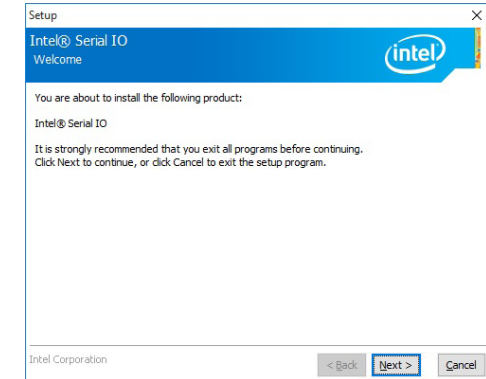

2. Read the license agreement carefully.

Click "I accept the terms in the License Agreement" then click Next.

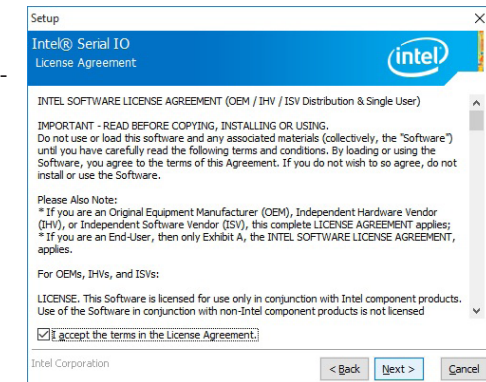

3. Read the file information then click Next.

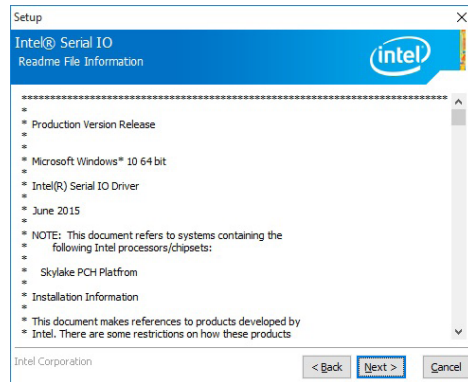

4. Setup is ready to install the driver. Click Next.

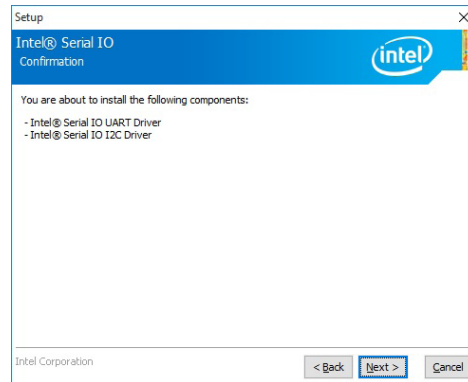

5. Setup is now installing the driver.

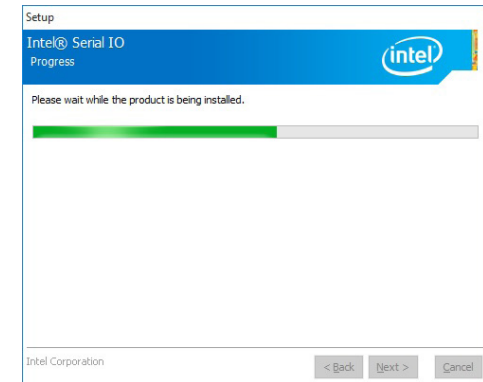

6. Click Finish.

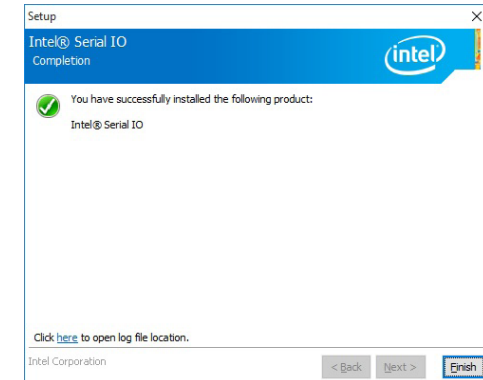

Adobe Acrobat Reader 9.3 (For Windows 7 and Windows 8.1)

To install the reader, click "Adobe Acrobat Reader 9.3" on the main menu.

1. Click Next to install or click Change Destination Folder to select another folder.

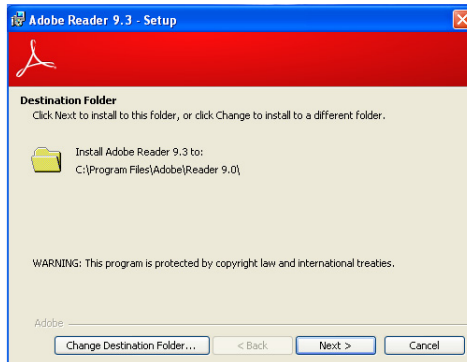

2. Click Install to begin installation.

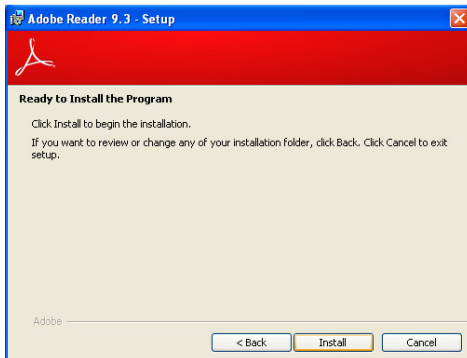

3. Click Finish to exit installation.

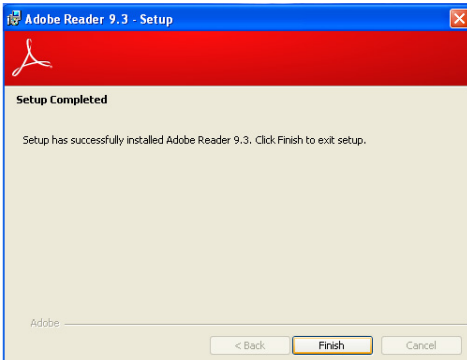

Appendix A - System Error Message

When the BIOS encounters an error that requires the user to correct something, either a beep code will sound or a message will be displayed in a box in the middle of the screen and the message, PRESS F1 TO CONTINUE, CTRL-ALT-ESC or DEL TO ENTER SETUP, will be shown in the information box at the bottom. Enter Setup to correct the error.

Error Messages

One or more of the following messages may be displayed if the BIOS detects an error during the POST. This list indicates the error messages for all Awards BIOSes:

CMOS BATTERY HAS FAILED

The CMOS battery is no longer functional. It should be replaced.



Important:

Danger of explosion if battery incorrectly replaced. Replace only with the same or equivalent type recommended by the manufacturer. Dispose of used batteries according to the battery manufacturer's instructions.

CMOS CHECKSUM ERROR

Checksum of CMOS is incorrect. This can indicate that CMOS has become corrupt. This error may have been caused by a weak battery. Check the battery and replace if necessary.

DISPLAY SWITCH IS SET INCORRECTLY

The display switch on the motherboard can be set to either monochrome or color. This indicates the switch is set to a different setting than indicated in Setup. Determine which setting is correct, either turn off the system and change the jumper or enter Setup and change the VIDEO selection.

FLOPPY DISK(S) fail (80)

Unable to reset floppy subsystem.

FLOPPY DISK(S) fail (40)

Floppy type mismatch.

Hard Disk(s) fail (80)

HDD reset failed.

Hard Disk(s) fail (40)

HDD controller diagnostics failed.

Hard Disk(s) fail (20)

HDD initialization error.

Hard Disk(s) fail (10)

Unable to recalibrate fixed disk.

Hard Disk(s) fail (08)

Sector Verify failed.

Keyboard is locked out - Unlock the key

The BIOS detects that the keyboard is locked. Keyboard controller is pulled low.

Keyboard error or no keyboard present

Cannot initialize the keyboard. Make sure the keyboard is attached correctly and no keys are being pressed during the boot.

Manufacturing POST loop

System will repeat POST procedure infinitely while the keyboard controller is pull low. This is also used for the M/B burn in test at the factory.

BIOS ROM checksum error - System halted

The checksum of ROM address F0000H-FFFFFH is bad.

Memory test fail

The BIOS reports memory test fail if the memory has error(s).

Appendix B - Troubleshooting Checklist

Troubleshooting Checklist

This chapter of the manual is designed to help you with problems that you may encounter with your personal computer. To efficiently troubleshoot your system, treat each problem individually. This is to ensure an accurate diagnosis of the problem in case a problem has multiple causes.

Some of the most common things to check when you encounter problems while using your system are listed below.

1. The power switch of each peripheral device is turned on.
2. All cables and power cords are tightly connected.
3. The electrical outlet to which your peripheral devices are connected is working. Test the outlet by plugging in a lamp or other electrical device.
4. The monitor is turned on.
5. The display's brightness and contrast controls are adjusted properly.
6. All add-in boards in the expansion slots are seated securely.
7. Any add-in board you have installed is designed for your system and is set up correctly.

Monitor/Display

If the display screen remains dark after the system is turned on:

1. Make sure that the monitor's power switch is on.
2. Check that one end of the monitor's power cord is properly attached to the monitor and the other end is plugged into a working AC outlet. If necessary, try another outlet.
3. Check that the video input cable is properly attached to the monitor and the system's display adapter.
4. Adjust the brightness of the display by turning the monitor's brightness control knob.

The picture seems to be constantly moving.

1. The monitor has lost its vertical sync. Adjust the monitor's vertical sync.
2. Move away any objects, such as another monitor or fan, that may be creating a magnetic field around the display.
3. Make sure your video card's output frequencies are supported by this monitor.

The screen seems to be constantly wavering.

1. If the monitor is close to another monitor, the adjacent monitor may need to be turned off. Fluorescent lights adjacent to the monitor may also cause screen wavering.

Power Supply

When the computer is turned on, nothing happens.

1. Check that one end of the AC power cord is plugged into a live outlet and the other end properly plugged into the back of the system.
2. Make sure that the voltage selection switch on the back panel is set for the correct type of voltage you are using.
3. The power cord may have a "short" or "open". Inspect the cord and install a new one if necessary.

Floppy Drive

The computer cannot access the floppy drive.

1. The floppy diskette may not be formatted. Format the diskette and try again.
2. The diskette may be write-protected. Use a diskette that is not write-protected.
3. You may be writing to the wrong drive. Check the path statement to make sure you are writing to the targeted drive.
4. There is not enough space left on the diskette. Use another diskette with adequate storage space.

Hard Drive

Hard disk failure.

1. Make sure the correct drive type for the hard disk drive has been entered in the BIOS.
2. If the system is configured with two hard drives, make sure the bootable (first) hard drive is configured as Master and the second hard drive is configured as Slave. The master hard drive must have an active/bootable partition.

Excessively long formatting period.

If your hard drive takes an excessively long period of time to format, it is likely a cable connection problem. However, if your hard drive has a large capacity, it will take a longer time to format.

Serial Port

The serial device (modem, printer) doesn't output anything or is outputting garbled characters.

1. Make sure that the serial device's power is turned on and that the device is on-line.
2. Verify that the device is plugged into the correct serial port on the rear of the computer.
3. Verify that the attached serial device works by attaching it to a serial port that is working and configured correctly. If the serial device does not work, either the cable or the serial device has a problem. If the serial device works, the problem may be due to the onboard I/O or the address setting.
4. Make sure the COM settings and I/O address are configured correctly.

Keyboard

Nothing happens when a key on the keyboard was pressed.

1. Make sure the keyboard is properly connected.
2. Make sure there are no objects resting on the keyboard and that no keys are pressed during the booting process.

System Board

1. Make sure the add-in card is seated securely in the expansion slot. If the add-in card is loose, power off the system, re-install the card and power up the system.
2. Check the jumper settings to ensure that the jumpers are properly set.
3. Verify that all memory modules are seated securely into the memory sockets.
4. Make sure the memory modules are in the correct locations.
5. If the board fails to function, place the board on a flat surface and seat all socketed components. Gently press each component into the socket.
6. If you made changes to the BIOS settings, re-enter setup and load the BIOS defaults.