

# **IB818F Series**

**Intel® Pentium® / Celeron® /  
Atom™ x7 SoC  
3.5" Disk-Size SBC**

## **User's Manual**

Version 3.0A  
(May 2022)

## **Copyright**

© 2022 IBASE Technology, Inc. All rights reserved.

No part of this publication may be reproduced, copied, stored in a retrieval system, translated into any language or transmitted in any form or by any means, electronic, mechanical, photocopying, or otherwise, without the prior written consent of IBASE Technology, Inc. (hereinafter referred to as "IBASE").

## **Disclaimer**

IBASE reserves the right to make changes and improvements to the products described in this document without prior notice. Every effort has been made to ensure the information in the document is correct; however, IBASE does not guarantee this document is error-free.

IBASE assumes no liability for incidental or consequential damages arising from misapplication or inability to use the product or the information contained herein, nor for any infringements of rights of third parties, which may result from its use.

## **Trademarks**

All the trademarks, registrations and brands mentioned herein are used for identification purposes only and may be trademarks and/or registered trademarks of their respective owners.

## Compliance

### CE

The product described in this manual complies with all applicable European Union (CE) directives if it has a CE marking. For systems to remain CE compliant, only CE-compliant parts may be used. Maintaining CE compliance also requires proper cable and cabling techniques.

### FC

This product has been tested and found to comply with the limits for a Class B device, pursuant to Part 15 of the FCC Rules. These limits are designed to provide reasonable protection against harmful interference in a residential installation. This equipment generates, uses and can radiate radio frequency energy and, if not installed and used in accordance with manufacturer's instructions, may cause harmful interference to radio communications.

### WEEE



This product must not be disposed of as normal household waste, in accordance with the EU directive of for waste electrical and electronic equipment (WEEE - 2012/19/EU). Instead, it should be disposed of by returning it to a municipal recycling collection point. Check local regulations for disposal of electronic products.

### Green IBASE



This product is compliant with the current RoHS restrictions and prohibits the use of the following substances in concentrations exceeding 0.1% by weight (1000 ppm) except for cadmium, limited to 0.01% by weight (100 ppm).

- Lead (Pb)
- Mercury (Hg)
- Cadmium (Cd)
- Hexavalent chromium (Cr6+)
- Polybrominated biphenyls (PBB)
- Polybrominated diphenyl ether (PBDE)

## Important Safety Information

Carefully read the safety information before using the board.

### Environmental conditions:

- Use this product in environments with ambient temperatures of 0°C ~ 60°C, or -40°C ~d 85 °C based on the specifications of the board you have purchased.
- Do not leave this product in an environment where the storage temperature is below -40° C or above 110° C. The product must be used in a controlled environment.

### Care for your iBASE products:

- Before cleaning the PCB, unplug all cables and remove the battery.
- Clean the PCB with a circuit board cleaner or degreaser, or use cotton swabs and alcohol.



### WARNING

### Attention during use:

- Do not use this product near water or a heat source.
- Do not spill water or any other liquids on this product.
- Do not place heavy objects on the top of this product.

### Anti-static precautions

- Wear an anti-static wrist strap to avoid electrostatic discharge.
- Place the PCB on an anti-static kit or mat.
- Hold the edges of the PCB when handling.
- Touch the edges of non-metallic components of the product instead of the surface of the PCB.
- Ground yourself by touching a grounded conductor or a grounded bit of metal frequently to discharge any static.



### CAUTION

There is a danger of explosion if the lithium-ion battery is replaced with an incorrect battery. Replace only with the same or equivalent type recommended by the manufacturer. Dispose of used batteries by observing local regulations.



## Warranty Policy

- **IBASE standard products:**

24-month (2-year) warranty from the date of shipment. If the date of shipment cannot be ascertained, the product serial numbers can be used to determine the approximate shipping date.

- **3<sup>rd</sup>-party parts:**

12-month (1-year) warranty from delivery for the 3<sup>rd</sup>-party parts that are not manufactured by IBASE, such as CPU, CPU cooler, memory, storage devices, power adapter, panel and touchscreen.

- \* PRODUCTS, HOWEVER, THAT FAIL DUE TO MISUSE, ACCIDENT, IMPROPER INSTALLATION OR UNAUTHORIZED REPAIR SHALL BE TREATED AS OUT OF WARRANTY AND CUSTOMERS SHALL BE BILLED FOR REPAIR AND SHIPPING CHARGES.

## Technical Support & Services

1. Visit the IBASE website at [www.ibase.com.tw](http://www.ibase.com.tw) to find the latest information about the product.
2. If you encounter any technical problems and require assistance from your distributor or sales representative, please prepare and send the following information:
  - Product model name
  - Product serial number
  - Detailed description of the problem
  - Error messages in text or screenshots if any
  - The arrangement of the peripherals
  - Software used (such as OS and application software)
3. If repair service is required, please download the RMA form at <http://www.ibase.com.tw/english/Supports/RMAService/>. Fill out the form and contact your distributor or sales representative.

# Table of Contents

---

<b>Chapter 1</b>	<b>General Information .....</b>	<b>1</b>
1.1	Introduction .....	2
1.2	Features .....	2
1.3	Packing List .....	3
1.4	Optional Accessories .....	3
1.5	Specifications .....	4
1.6	Block Diagram .....	6
1.7	Product View .....	7
1.8	Dimensions .....	9
<b>Chapter 2</b>	<b>Hardware Configuration .....</b>	<b>11</b>
2.1	Basic Installations .....	12
2.1.1	Installing the Memory .....	12
2.2	Setting the Jumpers .....	13
2.3	Jumper & Connector Locations .....	14
2.4	Jumpers Quick Reference .....	15
2.4.1	LVDS Panel Brightness Selection (JP1, JP4) .....	15
2.4.2	LVDS Panel Power Selection (JP2, JP3) .....	16
2.4.3	LCD Panel Backlight VCC (JP5, JP6) .....	16
2.4.4	ATX / AT Power Selection (JP7) .....	17
2.4.5	Clear CMOS Data (JP8) .....	17
2.4.6	Clear ME Register (JP9) .....	18
2.5	Connectors Quick Reference .....	19
2.5.1	LCD Backlight Connector (J3, J6) .....	20
2.5.2	LVDS Connector (CH1: J4, CH2: J1) (CH1: J5, CH2: J2) .....	20
2.5.3	Audio Connector (J23) .....	21
2.5.4	USB 2.0 Connector (J10) .....	21
2.5.5	SATA HDD Power Connector (J12) .....	22
2.5.6	COM2 / COM3 / COM4 RS-232 Port (J18, J19, J14) .....	23
2.5.7	Front Panel Connector (J16) .....	23
2.5.8	Digital I/O Connector (J22) .....	24
2.5.9	DC Power Input (J21) .....	24
2.5.10	COM1 RS-232/422/435 (CN10) .....	25
2.5.11	Amplifier Connector (J24) .....	26

<b>Chapter 3</b>	<b>Drivers Installation .....</b>	<b>27</b>
3.1	Introduction .....	28
3.2	Intel® Chipset Software Installation Utility .....	28
3.3	VGA Driver Installation.....	30
3.4	HD Audio Driver Installation .....	32
3.5	Intel® Trusted Execution Engine Drivers .....	34
3.6	Intel® Serial IO Drivers .....	36
3.7	LAN Driver Installation .....	38
<b>Chapter 4</b>	<b>BIOS Setup.....</b>	<b>41</b>
4.1	Introduction .....	42
4.2	BIOS Setup.....	42
4.3	Main Settings.....	43
4.4	Advanced Settings.....	44
4.5	Chipset Settings .....	57
4.6	Security Settings.....	63
4.7	Boot Settings .....	64
4.8	Save & Exit Settings .....	65
<b>Appendix</b>	<b>.....</b>	<b>67</b>
A.	I/O Port Address Map .....	68
B.	Interrupt Request Lines (IRQ) .....	70
C.	Watchdog Timer Configuration .....	71
D.	Onboard Connector Types.....	75

This page is intentionally left blank.

# Chapter 1

## General Information

The information provided in this chapter includes:

- Features
- Packing List
- Block Diagram
- Specifications
- Product View
- Board Dimensions

## 1.1 Introduction

IB818F is a 3.5" disk-size single board computer based on the Intel® Atom™ x7/x5, Pentium® or Celeron® processor. Supporting Intel® SoC integrated Gen. 9 graphics, it has HDMI and 24-bit dual channel LVDS display interfaces. The board also features a DDR3L-1600/1866 SO-DIMM slot, 2x GbE, 4x USB 3.0, 2x USB 2.0, 4x COM, 2x SATA III, and 2x Mini PCIe slot (full-size & half-size). Other functions include TPM, Watchdog timer, Digital I/O, mSATA, and EuP/ErP

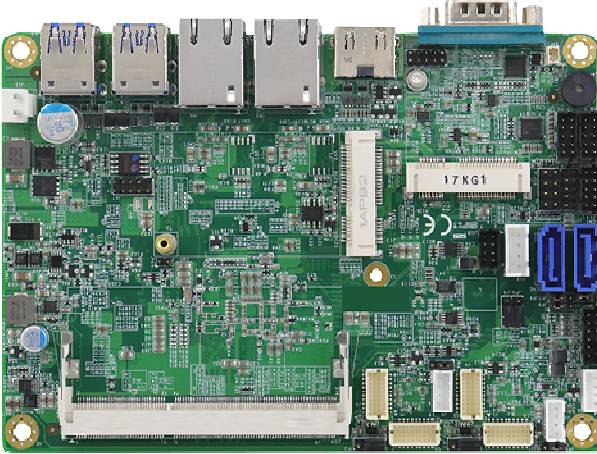

**IB818F**

## 1.2 Features

- 3.5" disk-size SBC with Intel® Atom™ x7-E3950 / x5-E3940 / x5-E3930 / Pentium® N4200 / Celeron® N3350
- 1 x DDR3L-1600/1866 SO-DIMM slots, expandable up to 8GB
- 1 x HDMI, 2 x 24-bit dual channel LVDS
- 2 x Gigabit LAN, 4 x USB 3.0, 2 x USB 2.0, 4 x COM, 2 x SATA III, 2 x Mini PCIe slot (full-size & half-size)
- TPM, Watchdog timer, Digital I/O, mSATA, EuP/ErP
- Wide-range operating temperature support for IB818F-I50, IB818F-I40, IB818F-I30

## 1.3 Packing List

Your IB818F package should include the items listed below. If any of the items is missing, contact your distributor or dealer from whom you have purchased the product.

- IB818F SBC
- Drivers Installation Disk  
(With chipset drivers and flash memory utility)
- This User's Manual

## 1.4 Optional Accessories

IBASE provides the following optional accessories:

- Cable Kit (**IB76A-1**), which includes:
  - SATA cable (SATA-53) x 1
  - Power cable (PW87) x 1
  - COM ports cable (PK1H) x 1
  - USB cable (USB29) x 1
- Heatsink for IB818F-I50, IB818F-I40, IB818F-I30 (**HSIB818-I**)
- Heat spreader for IB818F-I50, IB818F-I40, IB818F-I30 (**HSIB818-I-1**)
- Heatsink for IB818F-420 / IB818F-335 (**HSIB818**)
- Heat spreader for IB818F-420 / IB818F-335 (**HSIB818-1**)
- Audio cable (**Audio-18**)

## 1.5 Specifications

Product Name	IB818F-I50 IB818F-I40 IB818F-I30	IB818F-420 IB818F-335
Form Factor	3.5" disk-size SBC	
<b>System</b>		
Operating System	<ul style="list-style-type: none"> <li>• Windows 10 Enterprise (64-bit)</li> <li>• Windows 10 IoT Core (64-bit)</li> <li>• Linux Ubuntu</li> </ul>	
CPU Type	<ul style="list-style-type: none"> <li>• Intel® Atom™ QC x7 / E3950 (IB818F-I50)</li> <li>• Intel® Atom™ DC x5 / E3940 (IB818F-I40)</li> <li>• Intel® Atom™ DC x5 / E3930 (IB818F-I30)</li> </ul>	<ul style="list-style-type: none"> <li>• Intel® Pentium® QC N4200E (IB818F-420)</li> <li>• Intel® Celeron® DC N3350 (IB818F-335)</li> </ul>
CPU Speed	1.6~2.0GHz 1.6~1.8GHz 1.3~1.8GHz	1.1~2.5 GHz 1.1~ 2.4 GHz
Cache	2 MB	
Chipset	Integrated	
Memory	1 x DDR3L-1600/1866 SO-DIMM, expandable up to 8 GB (Non-ECC) * DDR3L-1600 is for IB818F-335 only.	
Storage	1 x mSATA SSD	
Graphics	Intel® SoC integrated Gen. 9	
Network	2 x Intel® I210IT PCIe GbE	2 x Intel® I211AT PCIe GbE
Super I/O	Fintek F81964D-I	
Audio Codec & Controller	Intel® SoC built-in HD audio controller Realtek ALC888S codec speaker amplifier TI TPA2012D2	
Power Requirement	12V~ 24V DC-In (jumper-selectable ATX / AT power mode)	
Watchdog Timer	Yes (256 segments, 0, 1, 2...255 sec / min)	
TPM	2.0	
BIOS	AMI BIOS	
H/W Monitor	Yes	



<b>Product Name</b>	<b>IB818F-I50</b> <b>IB818F-I40</b> <b>IB818F-I30</b>	<b>IB818F-420</b> <b>IB818F-335</b>
<b>Smart Control</b>	<ul style="list-style-type: none"> <li>• EuP/ErP</li> <li>• Power failure detection (via jumper)</li> <li>• LVDS brightness control</li> </ul>	
<b>Dimensions</b>	102.22 x 147.01 mm (4.02" x 5.8")	
<b>RoHS</b>	Yes	
<b>Certification</b>	CE, FCC Class B	
<b>I/O Ports</b>		
<b>Display</b>	<ul style="list-style-type: none"> <li>• <b>1 x HDMI (1.4b):</b> 3840 x 2160 at 30Hz</li> <li>• <b>2 x LVDS:</b> 1920 x 1200 at 60Hz</li> </ul>	
<b>LAN</b>	2 x RJ45 GbE LAN	
<b>USB</b>	<ul style="list-style-type: none"> <li>• <b>4 x USB 3.0:</b> edge I/O connectors</li> <li>• <b>2 x USB 2.0:</b> via an onboard pin header</li> </ul>	
<b>Serial</b>	<ul style="list-style-type: none"> <li>• <b>4 x COM ports:</b> <ul style="list-style-type: none"> <li>• COM1: RS-232/422/485 (edge I/O D-SUB9 connector, jumper-less selection)</li> <li>• COM2, COM3, COM4: RS-232 only (via onboard box-headers)</li> </ul> </li> </ul>	
<b>SATA</b>	2 x SATA III	
<b>Audio</b>	Onboard audio connector for Line-In, Line-Out, and Mic-In	
<b>Digital IO</b>	4-In & 4-Out	
<b>Expansion Slots</b>	<ul style="list-style-type: none"> <li>• 1 x Mini PCIe slot (full-size) with USB and mSATA</li> <li>• 1 x Mini PCIe slot (half-size) with USB only</li> </ul>	
<b>Environment</b>		
<b>Temperature</b>	<ul style="list-style-type: none"> <li>• Operating: -40°C ~ 85 °C (-40°F ~185 °F)</li> <li>• Storage: -40°C ~ 110 °C (-40°F ~ 230 °F)</li> </ul>	<ul style="list-style-type: none"> <li>• Operating: 0°C ~ 60 °C (32°F ~ 140 °F)</li> <li>• Storage: -40°C ~ 110 °C (-40°F ~ 230 °F)</li> </ul>
<b>Relative Humidity</b>	0 ~ 90 %, non-condensing at 60 °C	

All specifications are subject to change without prior notice.

## 1.6 Block Diagram

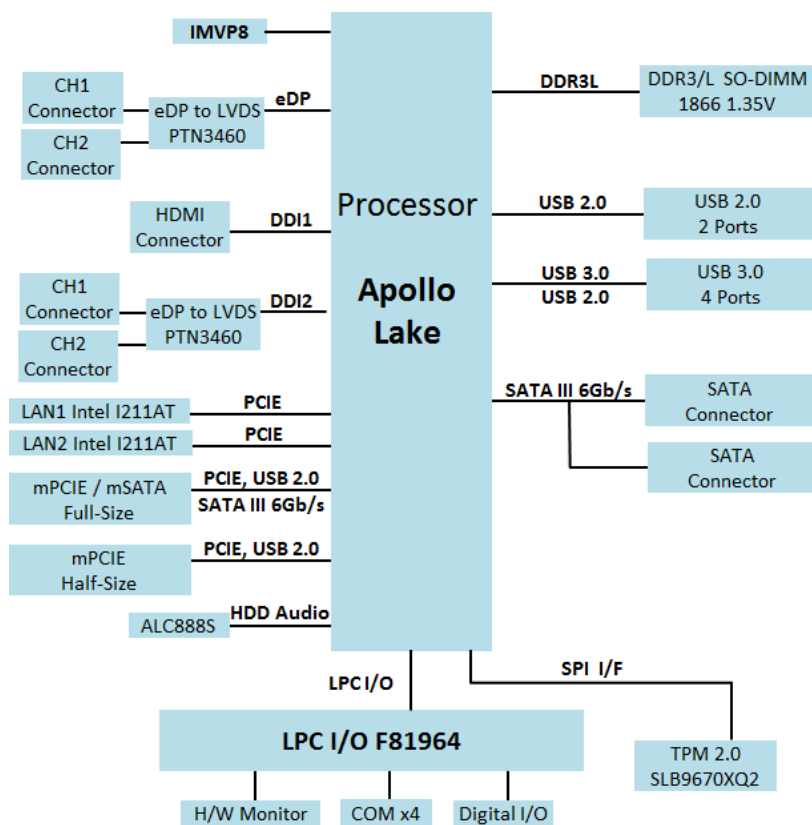

## 1.7 Product View

### Top View

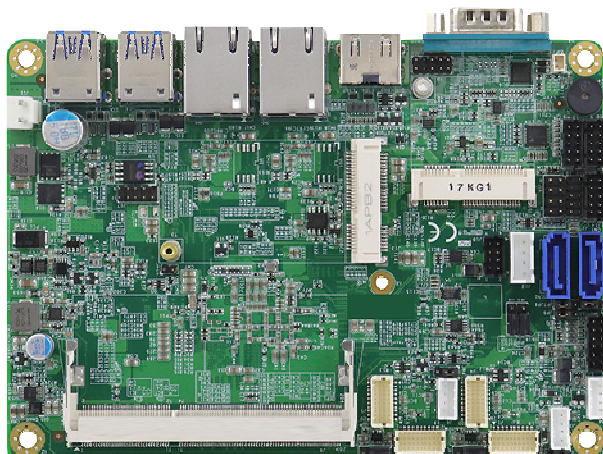

### Bottom View

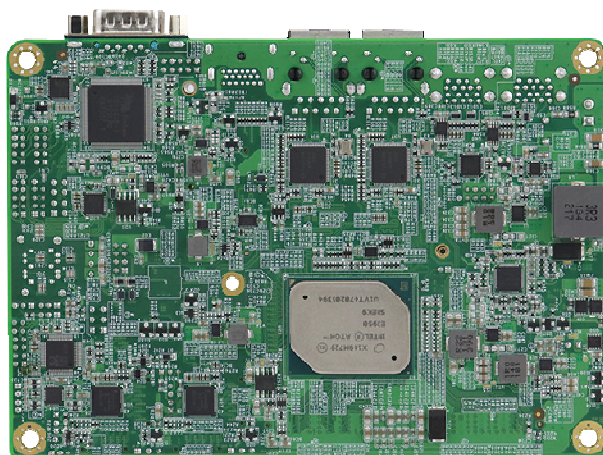

**IB818F**

\* The photos above are for reference only.

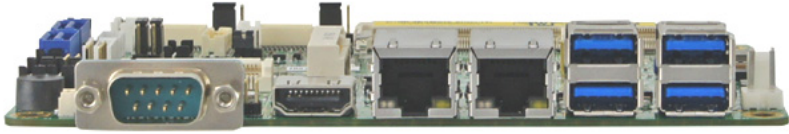

\* The I/O interface includes the following:

- D-SUB RS-232/422/485 port (CN10)
- HDMI port (CN9)
- LAN ports (CN5, CN6)
- USB 3.0 ports (CN7, CN8)

## 1.8 Dimensions

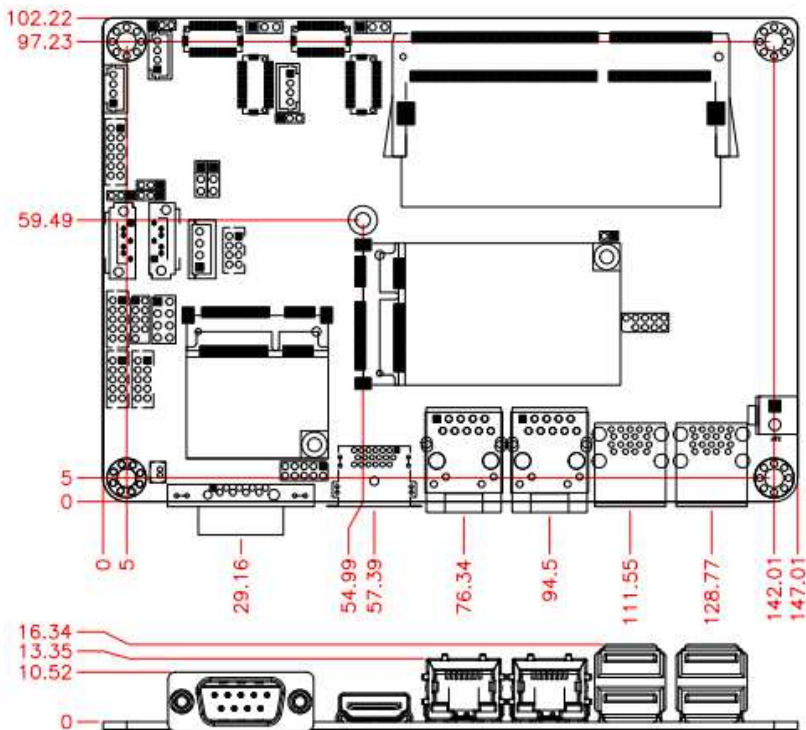

This page is intentionally left blank.

# Chapter 2

## Hardware Configuration

This section provides information on jumper settings and connectors on the IB818F to help you set up a workable system. The topics covered are:

- CPU and the memory installation
- Jumper settings and connectors

## 2.1 Basic Installations

Follow the instructions below to install the memory module.

### 2.1.1 Installing the Memory

The IB818F board supports two DDR3L memory sockets for a maximum total memory of 8 GB. To install the memory modules, locate the memory slot on the board and perform the following steps:

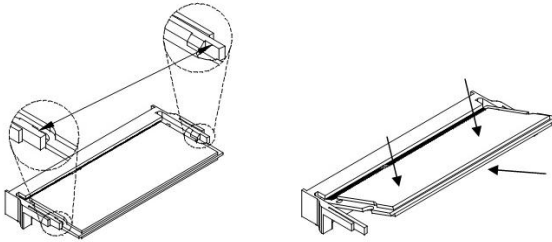

1. Align the notch of the memory module with that on the memory slot, and insert the module slantwise.
2. Gently push the module until the retention clips snap into place.

To remove the module, press the clips outwards with the fingers, and the module will pop-up.



## 2.2 Setting the Jumpers

Configure your IB818F by using jumpers to enable the features that you need based on your applications. Contact your supplier if you have doubts about the best configuration or settings.

### 2.2.1 How to Set Jumpers

Jumpers are short-length conductors consisting of several metal pins with a base mounted on the circuit board. Jumper caps are placed (or removed) on the pins to enable or disable functions or features. If a jumper has 3 pins, you can connect Pin 1 with Pin 2 or Pin 2 with Pin 3 by shorting the jumper.

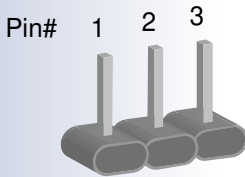



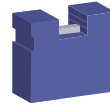

A 3-pin jumper

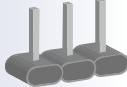
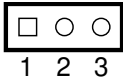

A jumper cap

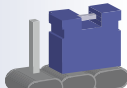
Refer to the illustration below to set a jumper.

Pins	Oblique view	Illustration
Open		 1 2 3
1-2		 1 2 3
2-3		 1 2 3

When two pins of a jumper are encased in a jumper cap, this jumper is **closed**, i.e. turned **On**.

When a jumper cap is removed from two jumper pins, this jumper is **open**, i.e. turned **Off**.

## 2.3 Jumper & Connector Locations

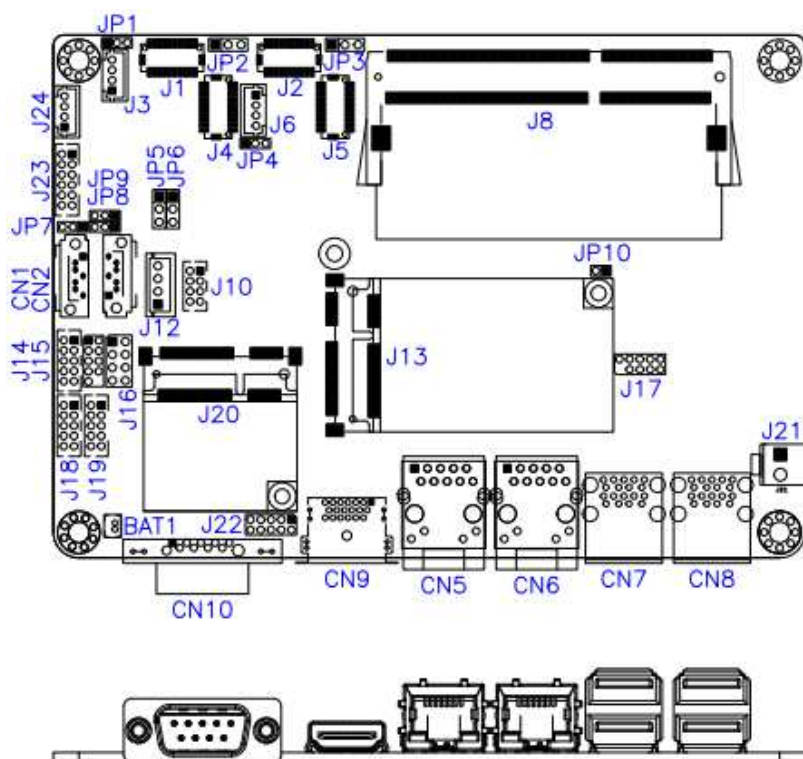

**IB818F**

## 2.4 Jumpers Quick Reference

Function	Jumper	Page
LCD Panel Brightness Selection	JP1, JP4	15
LVDS Panel Power Selection	JP2, JP3	16
LCD Panel Backlight VCC	JP5, JP6	16
ATX / AT Power Selection	JP7	17
Clear CMOS Data	JP8	17
Clear ME Register	JP9	18
Factory Use Only	JP10	--

### 2.4.1 LVDS Panel Brightness Selection (JP1, JP4)

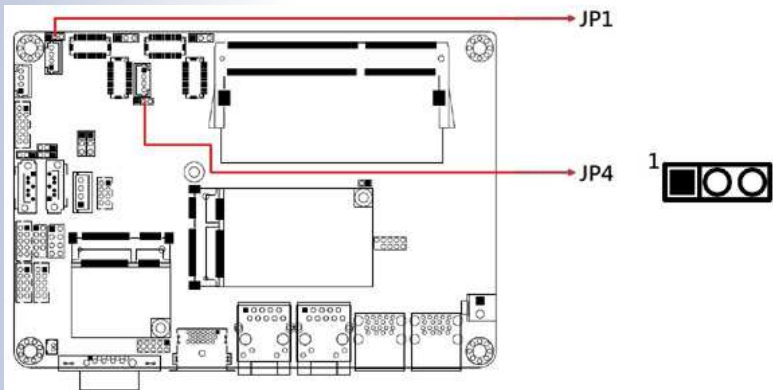

Function	Pin closed	Illustration
3.3V (default)	1-2	1
5V	2-3	1

### 2.4.2 LVDS Panel Power Selection (JP2, JP3)

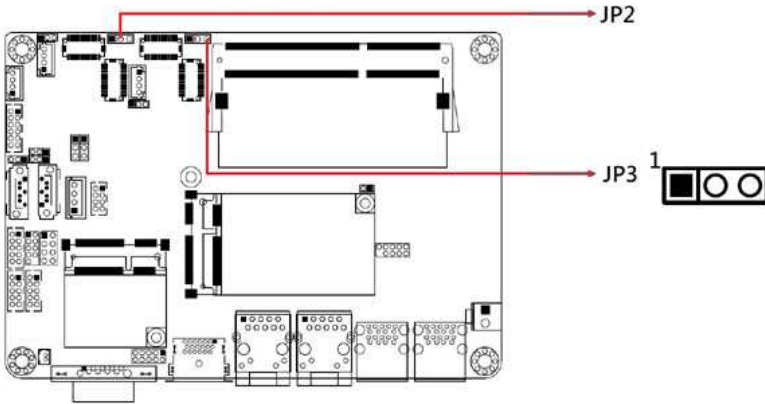

Function	Pin closed	Illustration
3.3V (default)	1-2	1
5V	2-3	1

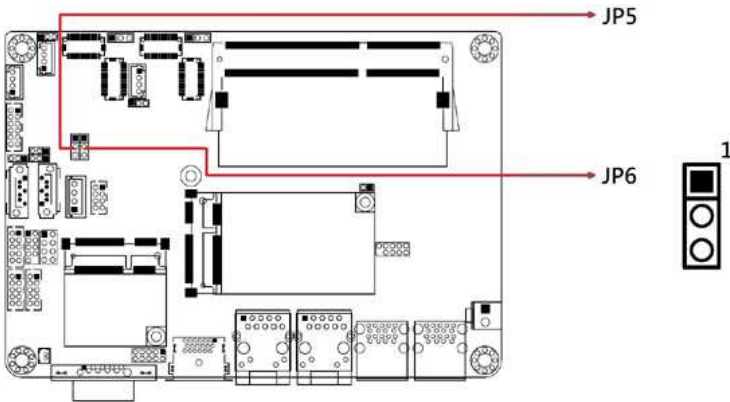

### 2.4.3 LCD Panel Backlight VCC (JP5, JP6)



Function	Pin closed	Illustration
5V (default)	1-2	1
12V	2-3	1

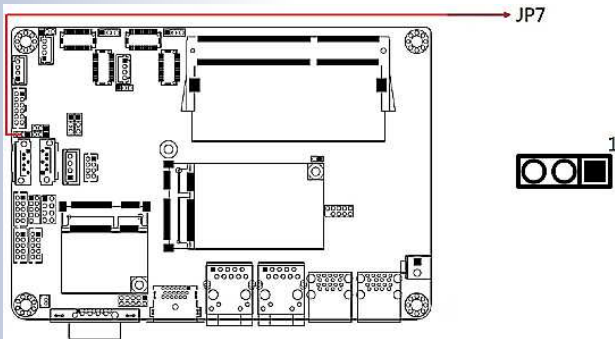

## 2.4.4 ATX / AT Power Selection (JP7)



Function	Pin closed	Illustration
ATX (default)	1-2	
AT	2-3	

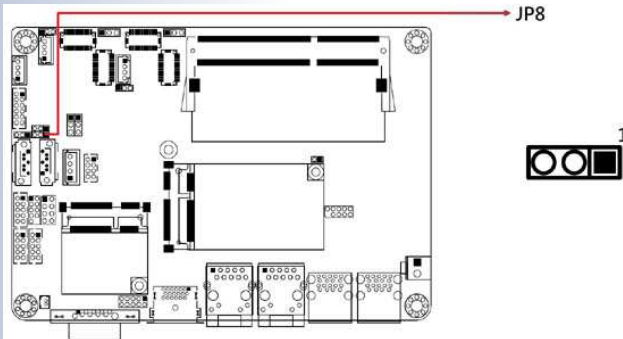

## 2.4.5 Clear CMOS Data (JP8)

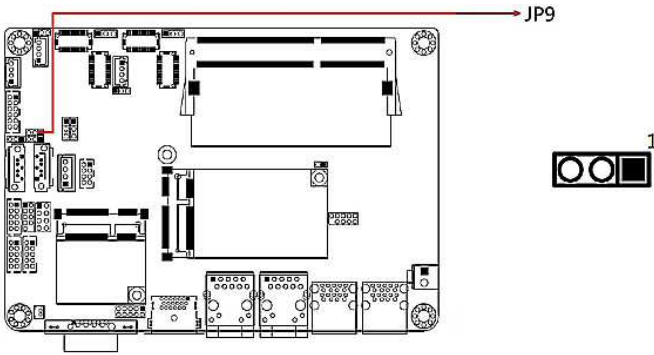

Function	Pin closed	Illustration
Normal (default)	1-2	
Clear CMOS	2-3	

## 2.4.6 Clear ME Register (JP9)



Function	Pin closed	Illustration
Normal (default)	1-2	
Clear ME	2-3	

## 2.5 Connectors Quick Reference

Function	Connector	Page
SATA III	CN1, CN2	--
LAN Ports	CN5, CN6	--
USB 3.0	CN7, CN8	--
HDMI	CN9	--
LCD Backlight	J3, J6	20
LVDS	CH1: J4, CH2: J1 CH1: J5, CH2: J2	20
Audio	J23	21
Amplifier	J24	26
DDR3L SO-DIMM	J8	--
USB 2.0	J10	21
SATA HDD Power	J12	22
COM2 / COM3 / COM4 RS-232	J18, J19, J14	23
Mini PCIe / mSATA	J13 (shared with CN2)	--
Mini PCIe	J20	--
Front Panel	J16	23
COM Digital I/O	J22	24
DC Power Input	J21	24
COM1 RS-232/422/485	CN10	25
Factory Use Only	J17,J15	--

### 2.5.1 LCD Backlight Connector (J3, J6)

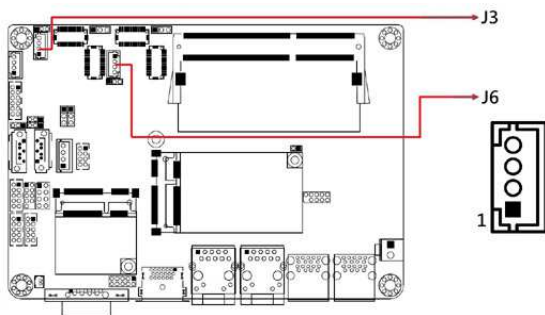

Pin	Signal	Pin	Signal
1	+12V / +5V	3	Brightness Control
2	Backlight Enable	4	Ground

### 2.5.2 LVDS Connector (CH1: J4, CH2: J1) (CH1: J5, CH2: J2)

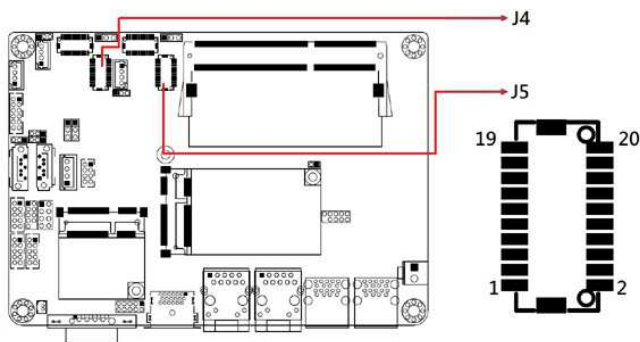

Pin	Signal	Pin	Signal
1	TX0P	2	TX0N
3	Ground	4	Ground
5	TX1P	6	TX1N
7	Ground	8	Ground
9	TX2P	10	TX2N
11	Ground	12	Ground
13	CLKP	14	CLKN
15	Ground	16	Ground
17	TX3P	18	TX3N
19	VDD	20	VDD



### 2.5.3 Audio Connector (J23)

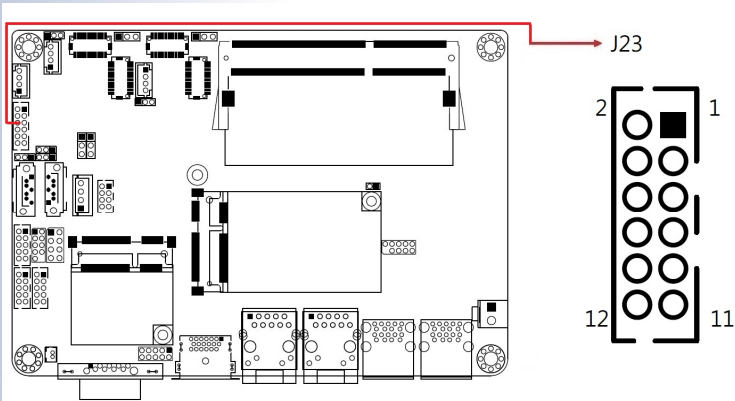

Pin	Signal	Pin	Signal
1	Lineout_L	2	Lineout_R
3	JD_FRONT	4	Ground
5	LINEIN_L	6	Linein_R
7	JD_LINEIN	8	Ground
9	MIC_L	10	MIC-R
11	JD_MIC1	12	Ground

### 2.5.4 USB 2.0 Connector (J10)

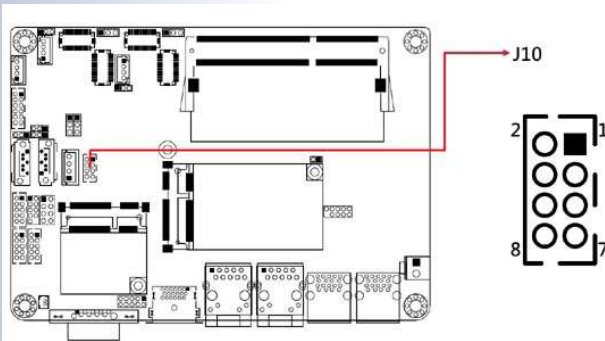

Pin	Signal	Pin	Signal
1	VCC	2	Ground
3	D0-	4	D1+
5	D0+	6	D1-
7	Ground	8	VCC

## 2.5.5 SATA HDD Power Connector (J12)

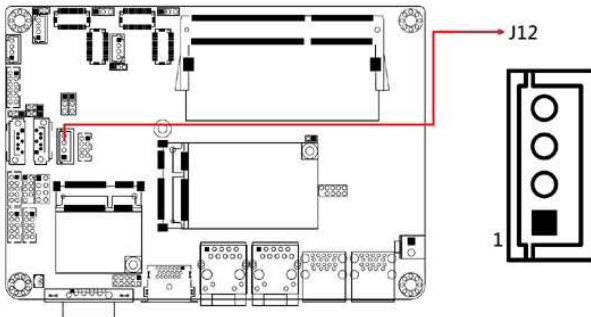

Pin	Signal	Pin	Signal
1	+5V	3	Ground
2	Ground	4	+12V

## 2.5.6 COM2 / COM3 / COM4 RS-232 Port (J18, J19, J14)

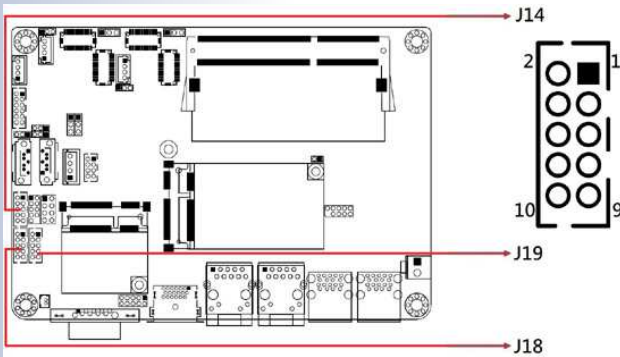

Pin	Signal	Pin	Signal
1	DCD, Data carrier detect	2	RXD, Receive data
3	TXD, Transmit data	4	DTR, Data terminal ready
5	Ground	6	DSR, Data set ready
7	RTS, Request to send	8	CTS, Clear to send
9	RI, Ring indicator	10	Not Used

## 2.5.7 Front Panel Connector (J16)

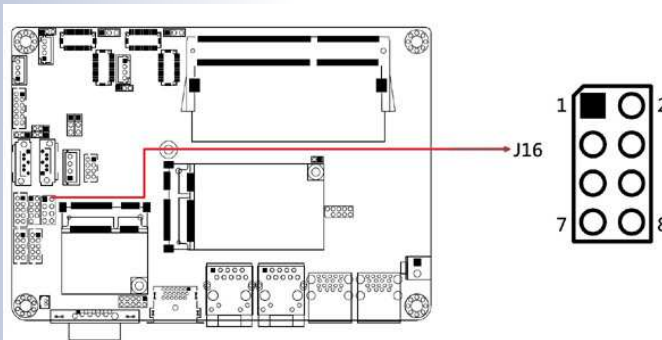

Pin	Signal	Pin	Signal
1	Ground	2	PWR_BTN
3	3.3V	4	HDD Active
5	Ground	6	Reset
7	+5V	8	Ground

## 2.5.8 Digital I/O Connector (J22)

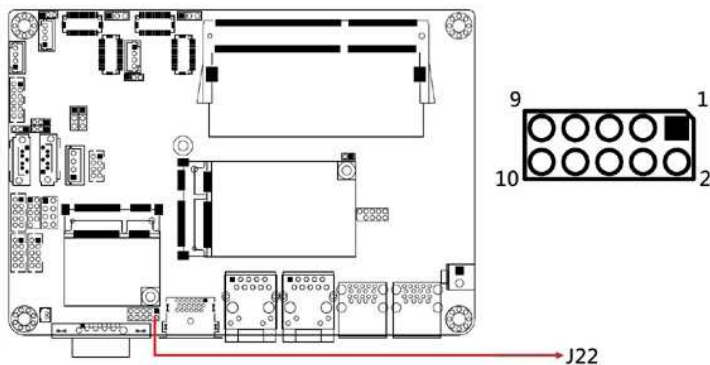

Pin	Signal	Pin	Signal
1	Ground	2	VCC
3	OUT3	4	OUT1
5	OUT2	6	OUT0
7	IN3	8	IN1
9	IN2	10	IN0

## 2.5.9 DC Power Input (J21)

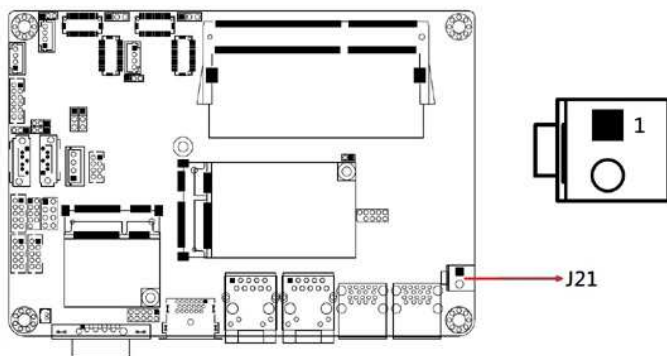

Pin	Signal	Pin	Signal
1	+12V ~ +24V	2	Ground

## 2.5.10 COM1 RS-232/422/435 (CN10)

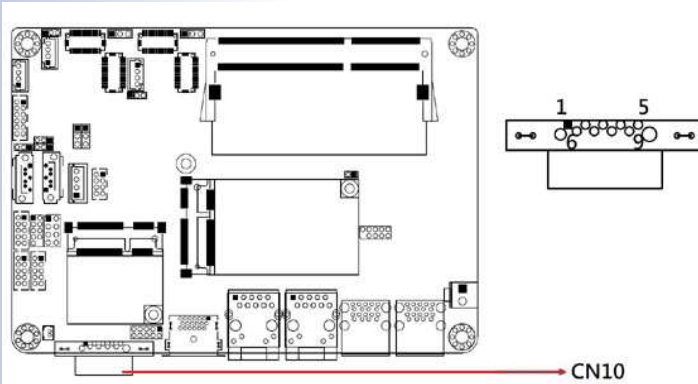

Pin	Signal	Pin	Signal
1	DCD, Data carrier detect	6	DSR, Data set ready
2	RXD, Receive data	7	RTS, Request to send
3	TXD, Transmit data	8	CTS, Clear to send
4	DTR, Data terminal ready	9	RI, Ring indicator
5	Ground		

Pin	Signal		
	RS-232	RS-422	RS-485
1	DCD	TX-	DATA-
2	RX	TX+	DATA+
3	TX	RX+	NC
4	DTR	RX-	NC
5	Ground	Ground	Ground
6	DSR	NC	NC
7	RTS	NC	NC
8	CTS	NC	NC
9	RI	NC	NC

## 2.5.11 Amplifier Connector (J24)

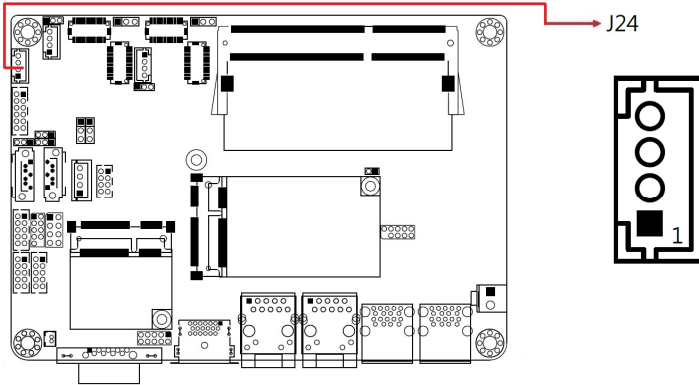

Pin	Signal Name	Pin	Signal Name
1	OUTL+	3	OUTR-
2	OUTL-	4	OUTR+

# Chapter 3

## Drivers Installation

This chapter introduces installation of the following drivers:

- Intel® Chipset Software Installation Utility
- VGA Driver
- HD Audio Driver
- Intel® Trusted Execution Engine Installation
- Intel® Serial I/O Drivers
- LAN Driver

## 3.1 Introduction

This section describes the installation procedures for software and drivers. The software and drivers are included with the motherboard. If you find anything missing, please contact the distributor where you made the purchase. The contents of this section include the following:

---

**Note:** After installing your Windows operating system, you must install the Intel® Chipset Software Installation Utility first before proceeding with the drivers installation.

---

## 3.2 Intel® Chipset Software Installation Utility

The Intel® Chipset drivers should be installed first before the software drivers to install INF files for Plug & Play function for Intel chipset components. Follow the instructions below to complete the installation.

1. Insert the disk enclosed in the package with the board. Click **Intel** on the left pane and then **Intel(R) Apollolake Chipset Drivers** on the right pane.





2. Click **Intel(R) Chipset Software Installation Utility**.



3. When the *Welcome* screen to the Intel® Chipset Device Software appears, click **Next** to continue.
4. Click **Yes** to accept the software license agreement and proceed with the installation process.
5. On the *Readme File Information* screen, click **Install** for installation.

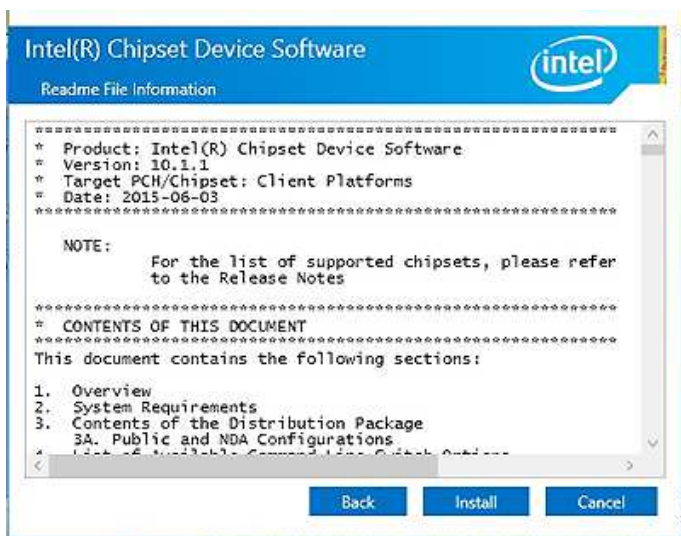

6. After the driver has been completely installed, restart the computer for changes to take effect.

### 3.3 VGA Driver Installation

1. Click **Intel** on the left pane and then **Intel(R) Apollolake Chipset Drivers** on the right pane.

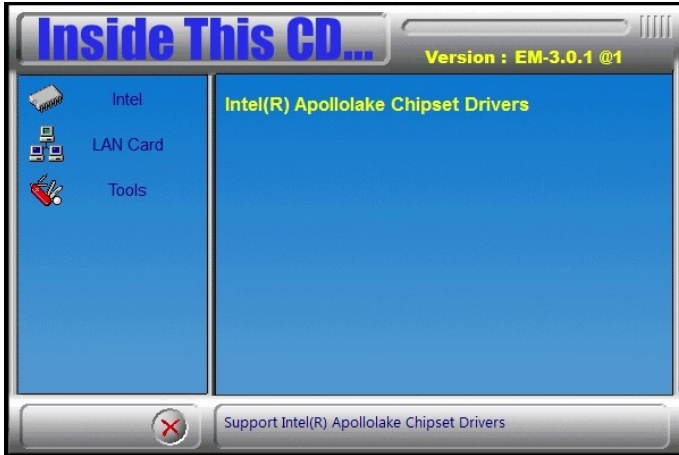

2. Click **Intel(R) Apollolake Graphics Driver**.



3. When the *Welcome* screen appears, click **Next** to continue.

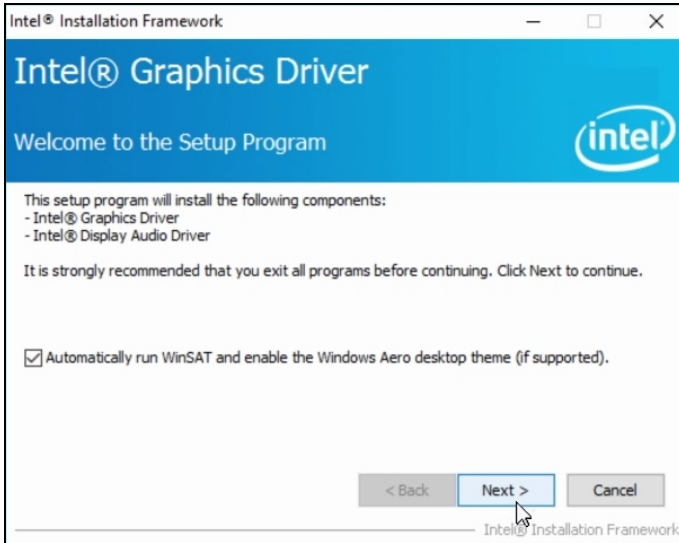

4. Click **Yes** to accept the license agreement and click **Next** until the installation starts.
5. After the driver has been completely installed, restart the computer for changes to take effect.

### 3.4 HD Audio Driver Installation

1. Click **Intel** on the left pane and then **Intel(R) Apollolake Chipset Drivers** on the right pane.

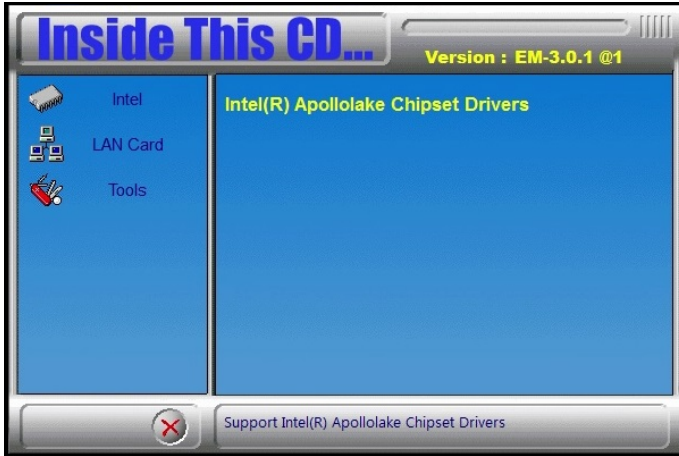

2. Click **Realtek High Definition Audio Driver**.



3. On the *Welcome* screen of the InstallShield Wizard, click **Next**.

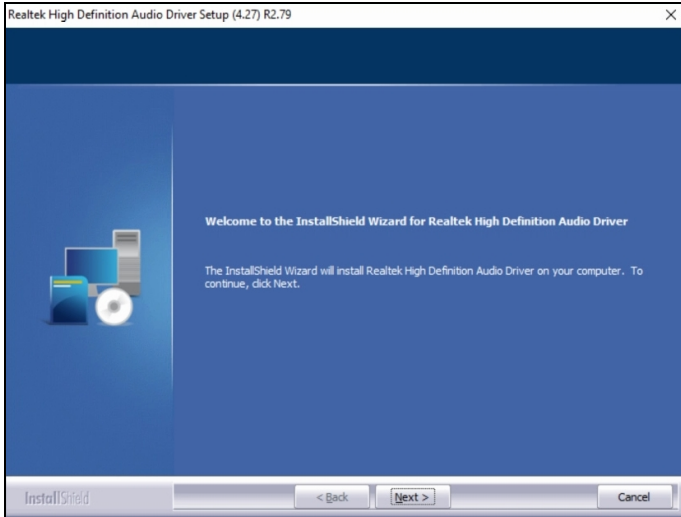

4. Click **Next** to start the installation process.
5. After the driver has been completely installed, restart the computer for changes to take effect.

### 3.5 Intel® Trusted Execution Engine Drivers

1. Click **Intel** on the left pane and then **Intel(R) Apollolake Chipset Drivers** on the right pane.

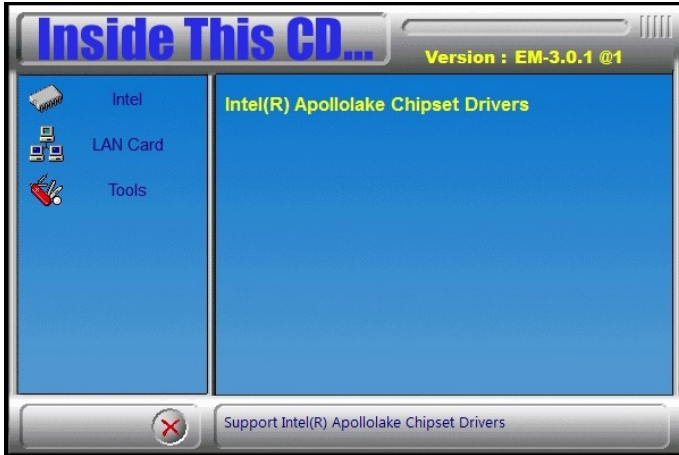

2. Click **Intel(R) TXE Drivers**.



- When the *Welcome* screen appears, click **Next**.

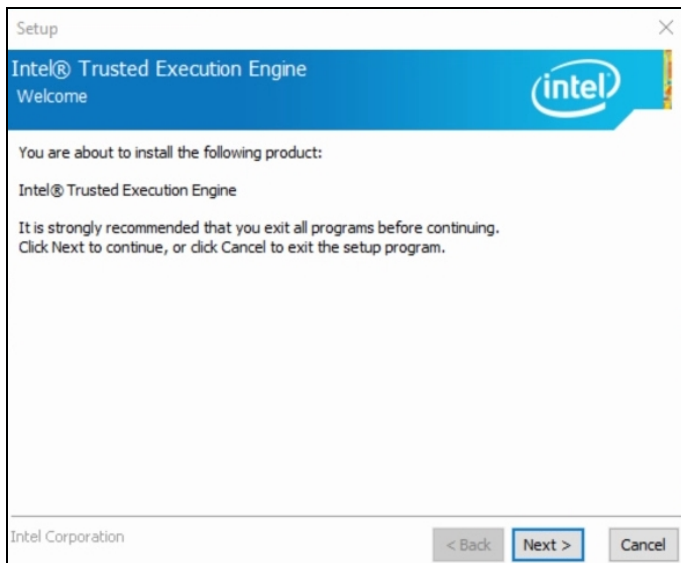

- Accept the license agreement and click **Next**.
- Click **Next** to start the installation process.

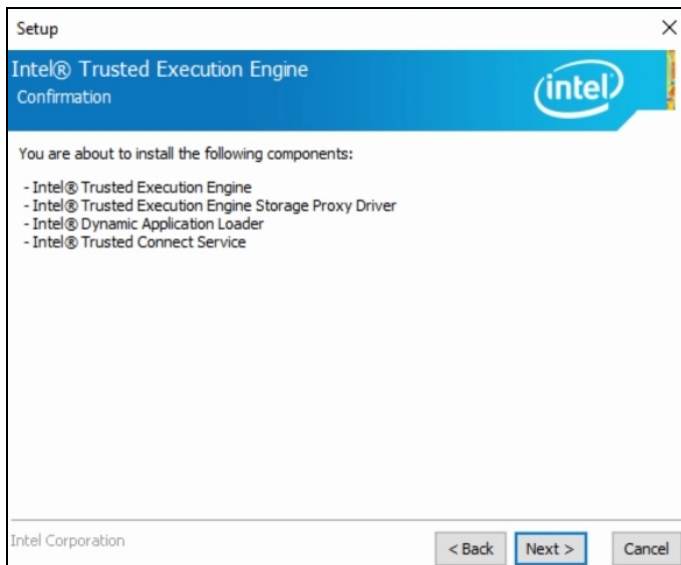

- After the driver has been successfully installed, restart the computer for changes to take effect.

### 3.6 Intel® Serial IO Drivers

1. Click **Intel** on the left pane and then **Intel(R) Apollolake Chipset Drivers** on the right pane.

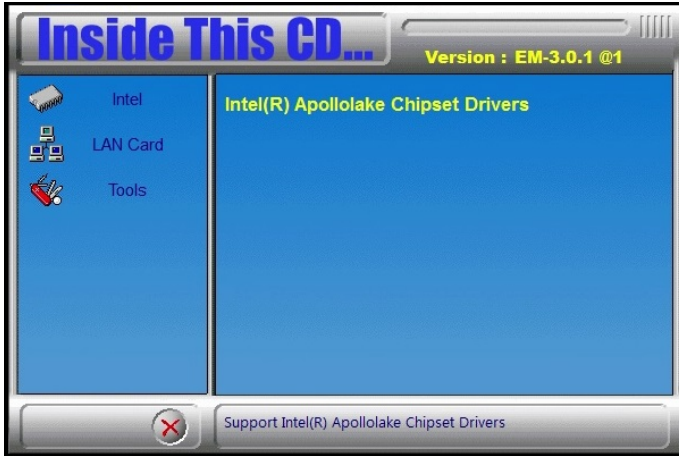

2. Click **Intel(R) Serial IO Drivers**.





3. When the *Welcome* screen to the InstallShield Wizard appears, click **Next**.

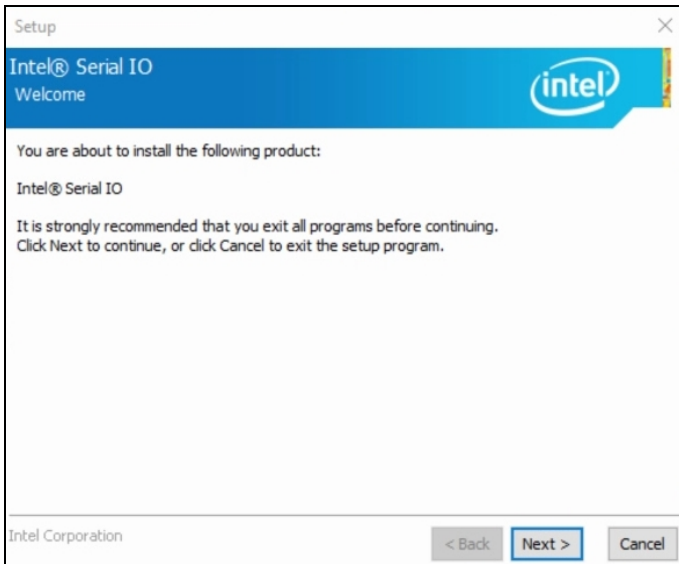

4. Accept the license agreement and click **Next**.
5. After reading the *Readme File Information*, click **Next**.
6. After the driver has been successfully installed, restart the computer for changes to take effect.

### 3.7 LAN Driver Installation

1. Click **LAN Card** on the left pane and then **Intel LAN Controller Drivers** on the right pane.



2. Click **Intel(R) I21x Gigabit Network Drivers..**

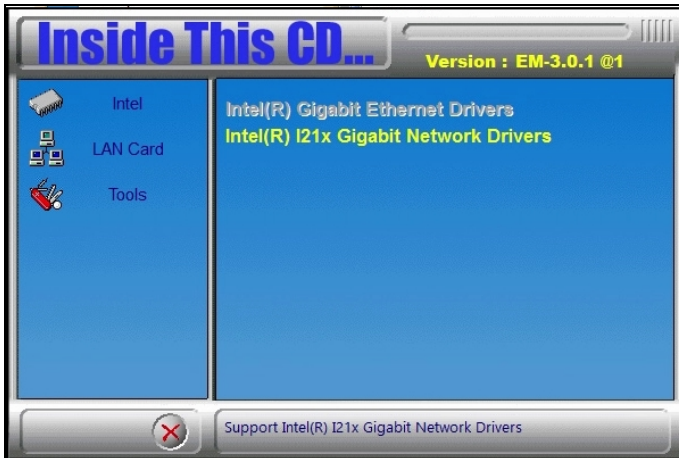

- When the *Welcome* screen appears, click **Next**.

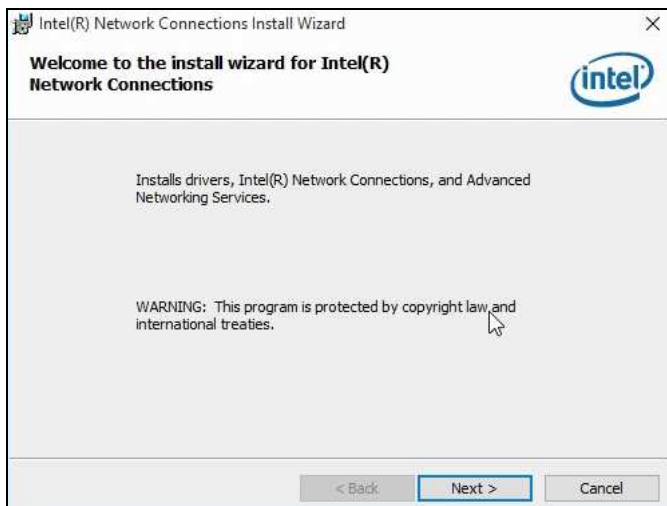

- Accept the license agreement and click **Next**.
- On the *Setup Options* screen, click the checkbox to select the desired driver(s) for installation. Then click **Next** to continue.

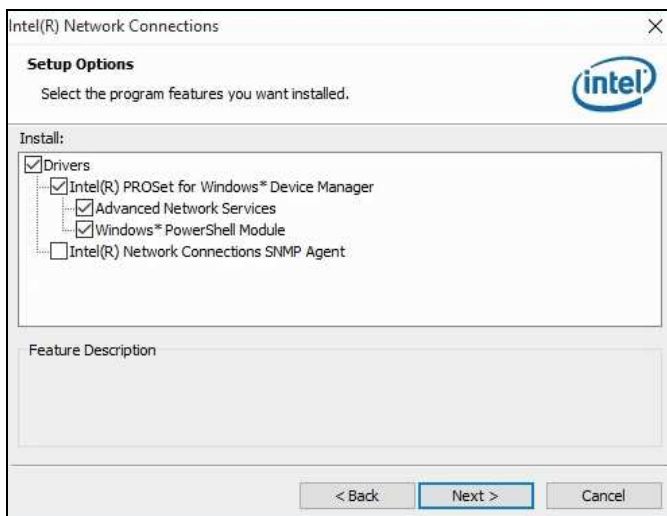

- The wizard is ready for installation. Click **Install**.
- After the installation is complete, restart the computer for changes to take effect.

This page is intentionally left blank.

# Chapter 4

## BIOS Setup

This chapter describes the different settings available in the AMI BIOS that comes with the board. The topics covered in this chapter are as follows:

- Main Settings
- Advanced Settings
- Chipset Settings
- Security Settings
- Boot Settings
- Save & Exit

## 4.1 Introduction

The BIOS (Basic Input/Output System) installed in the ROM of your computer system supports Intel® processors. The BIOS provides critical low-level support for standard devices such as disk drives, serial ports and parallel ports. It also provides password protection as well as special support for detailed fine-tuning of the chipset controlling the entire system.

## 4.2 BIOS Setup

The BIOS provides a Setup utility program for specifying the system configurations and settings. The BIOS ROM of the system stores the Setup utility. When you turn on the computer, the BIOS is immediately activated. Press the <Del> key immediately allows you to enter the Setup utility. If you are a little bit late pressing the <Del> key, POST (Power On Self Test) will continue with its test routines, thus preventing you from invoking the Setup.

If you still need to enter Setup, restart the system by pressing the "Reset" button or simultaneously pressing the <Ctrl>, <Alt> and <Delete> keys. You can also restart by turning the system Off and back On again.

The following message will appear on the screen:

```
Press <DEL> to Enter Setup
```

In general, press the arrow keys to highlight items, <Enter> to select, the <PgUp> and <PgDn> keys to change entries, <F1> for help, and <Esc> to quit.

When you enter the BIOS Setup utility, the *Main Menu* screen will appear on the screen. The Main Menu allows you to select from various setup functions and exit choices.

---

**Warning:** It is strongly recommended that you avoid making any changes to the chipset defaults.

These defaults have been carefully chosen by both AMI and your system manufacturer to provide the absolute maximum performance and reliability. Changing the defaults could make the system unstable and crash in some cases.

---

## 4.3 Main Settings

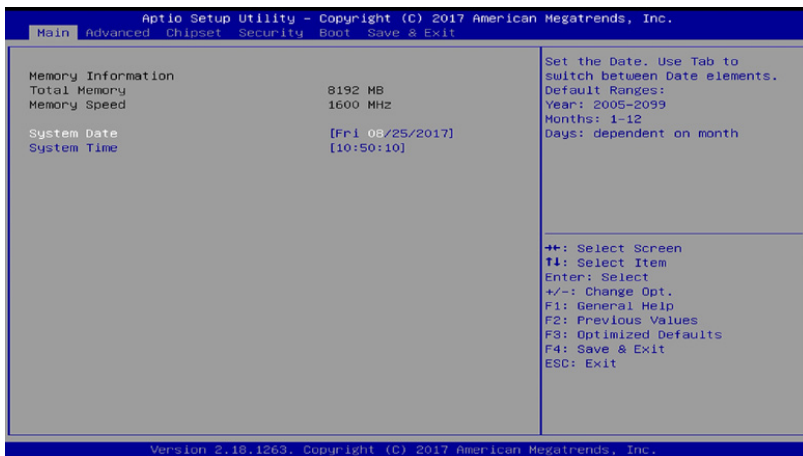

BIOS Setting	Description
System Date	Sets the date. Use the <Tab> key to switch between the data elements.
System Time	Set the time. Use the <Tab> key to switch between the data elements.

## 4.4 Advanced Settings

This section allows you to configure, improve your system and allows you to set up some system features according to your preference.

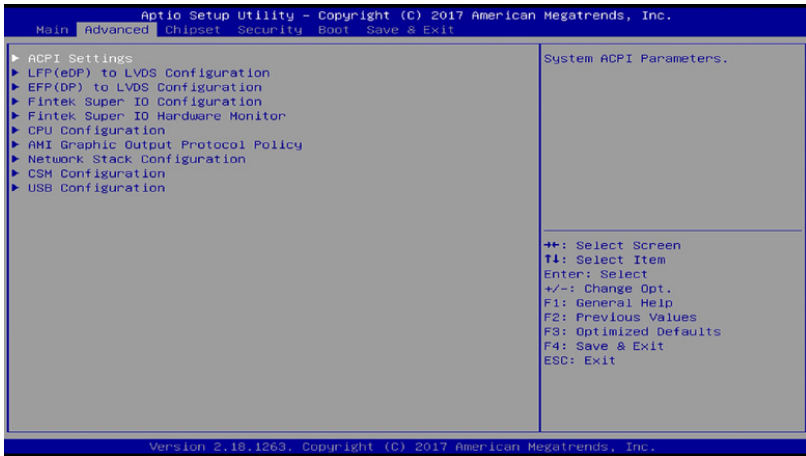



### 4.4.1 ACPI Computing

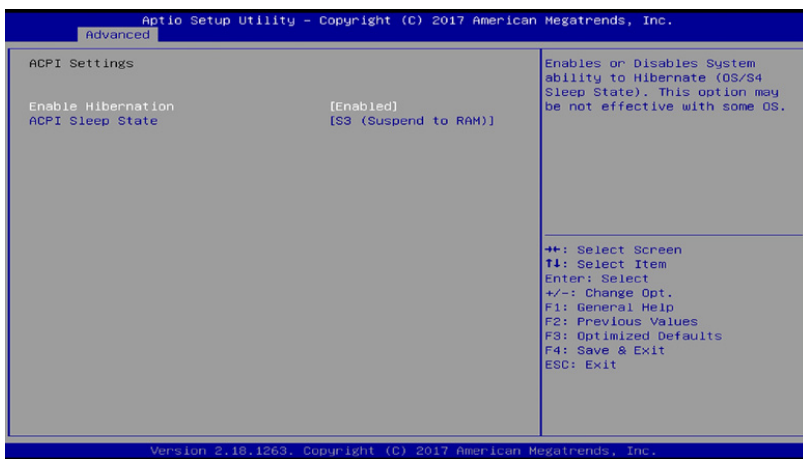

BIOS Setting	Description
Enable Hibernation	Enables / Disables the system ability to hibernate (OS/S4 Sleep State). This option may be not effective with some OS.
ACPI Sleep State	Selects an ACPI sleep state (Suspend Disabled or S3) where the system will enter when the Suspend button is pressed.

## 4.4.2 LFP (eDP) to LVDS Configuration



BIOS Setting	Description
LVDS Support	Enables / Disables eDP to LVDS.
Panel Color Depth	Selects a panel color depth as 18 or 24 (VESA or JEIDA) bit.
LVDS Channel Type	Sets the LVDS channel type as single or dual channel.
Panel Type	Selects a resolution that fits your panel. Options: 800 x 600 / 1024 x 768 / 1280 x 1024 / 1366 x 768 / 1440 x 900 / 1600 x 900 / 1920 x 1080
LVDS Backlight Level Control	Selects from Level 1 to Level 8 for the LVDS backlight.

### 4.4.3 EFP (DP) to LVDS Configuration



BIOS Setting	Description
LVDS Support	Enables / Disables DP to LVDS.
Panel Color Depth	Selects a panel color depth as 18 or 24 (VESA or JEIDA) bit.
LVDS Channel Type	Sets the LVDS channel type as single or dual channel.
Panel Type	Selects a resolution that fits your panel. Options: 800 x 600 / 1024 x 768 / 1280 x 1024 / 1366 x 768 / 1440 x 900 / 1600 x 900 / 1920 x 1080
LVDS Backlight Level Control	Selects from Level 1 to Level 8 for the LVDS backlight.

## 4.4.4 Fintek Super IO Configuration

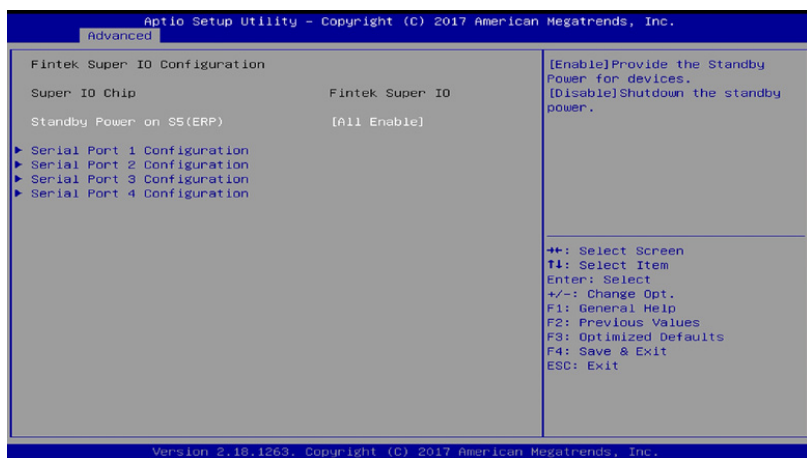

BIOS Setting	Description
Standby Power on S5 (ERP)	<p>Enable the item to provide the standby power for devices.</p> <p>Disable the item to shut down the standby power.</p> <p>Options: All Enable / Enable Ethernet for WOL / All Disable</p>
Serial Ports Configuration	<p>Sets parameters of serial ports.</p> <p>Enables / Disables the serial port and select an optimal setting for the Super IO device.</p>

### 4.4.4.1. Serial Port 1 Configuration

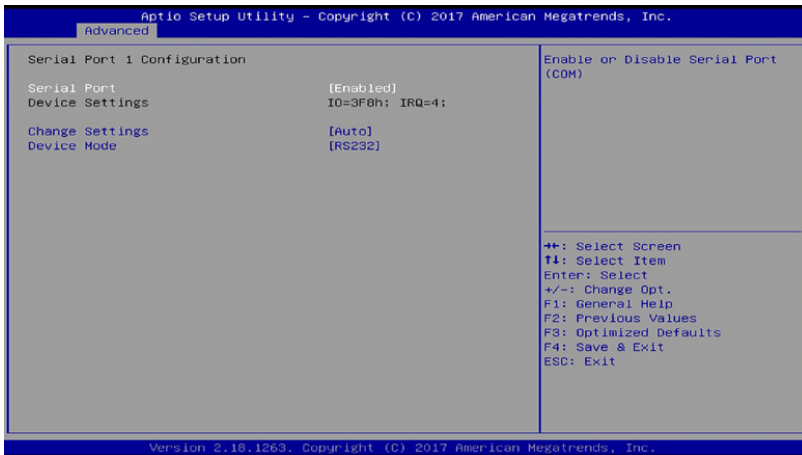

BIOS Setting	Description
Serial Port	Enables / Disables the serial port.
Change Settings	Selects an optimal settings for Super IO device.
Device Mode	Changes the serial port mode to: <ul style="list-style-type: none"> <li>• RS232</li> <li>• RS485 TX Low Active</li> <li>• RS485 with Termination TX Low Active</li> <li>• RS422</li> <li>• RS422 with Termination</li> </ul>

## 4.4.5 Fintek Super IO Hardware Monitor



BIOS Setting	Description
Temperatures / Voltages	These fields are the parameters of the hardware monitoring function feature of the motherboard. The values are read-only values as monitored by the system and show the PC health status.
CPU Shutdown Temperature	Sets a threshold of temperature to shut down if CPU goes overheated. Options: Disabled / 70 °C / 75 °C / 80 °C / 85 °C / 90 °C / 95 °C

## 4.4.6 CPU Configuration



BIOS Setting	Description
Socket 0 CPU Information	Displays the socket specific CPU information.
CPU Power Management	Allows you to enable / disable Turbo Mode.
Active Processor Cores	Enables / Disables the cores in the processor package.
Monitor Mwait	Enables / Disables Monitor Mwait.

**4.4.6.1. Socket 0 CPU Information**

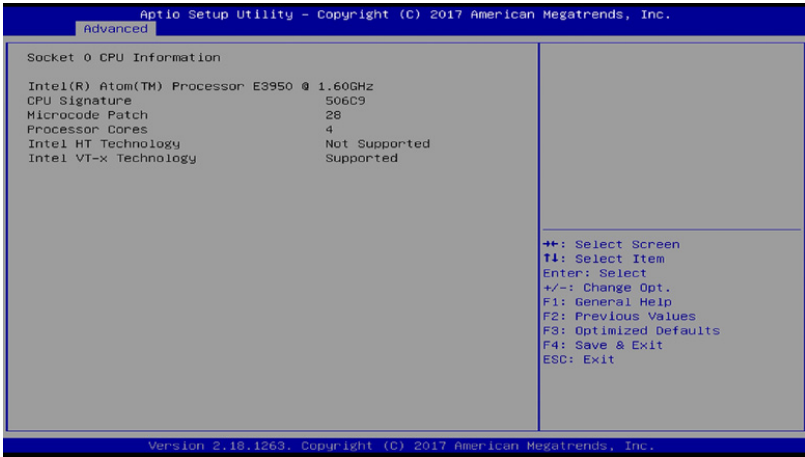

**4.4.6.2. CPU Power Management Configuration**



BIOS Setting	Description
Turbo Mode	Enables / Disables the turbo mode.



## 4.4.7 AMI Graphic Output Protocol Policy

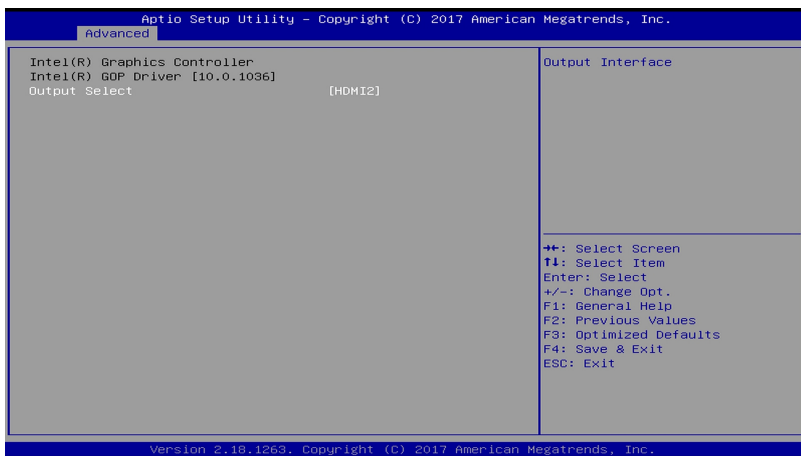

BIOS Setting	Description
Output Select	Outputs through HDMI interface.

## 4.4.8 Network Stack Configuration

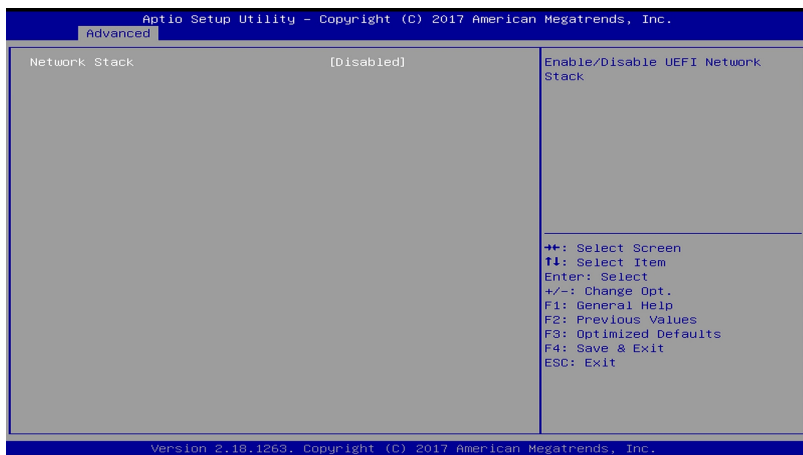

BIOS Setting	Description
Network Stack	Enables / Disables UEFI Network Stack.
IPv4 PXE Support	Enables / Disables IPv4 PXE Boot Support. If disabled, Ipv4 PXE boot option will not be created.
IPv4 HTTP Support	Enables / Disables IPv4 HTTP Boot Support. If disabled, Ipv4 HTTP boot option will not be created.
IPv6 PXE Support	Enables / Disables IPv6 PXE Boot Support. If disabled, Ipv4 PXE boot option will not be created.
IPv6 HTTP Support	Enables / Disables IPv6 HTTP Boot Support. If disabled, Ipv4 HTTP boot option will not be created.
PXE boot wait time	Assigns a period of time to press ESC key to abort the PXE boot.
Media detect count	Assigns a number of times to check the presence of media.

## 4.4.9 CSM Configuration

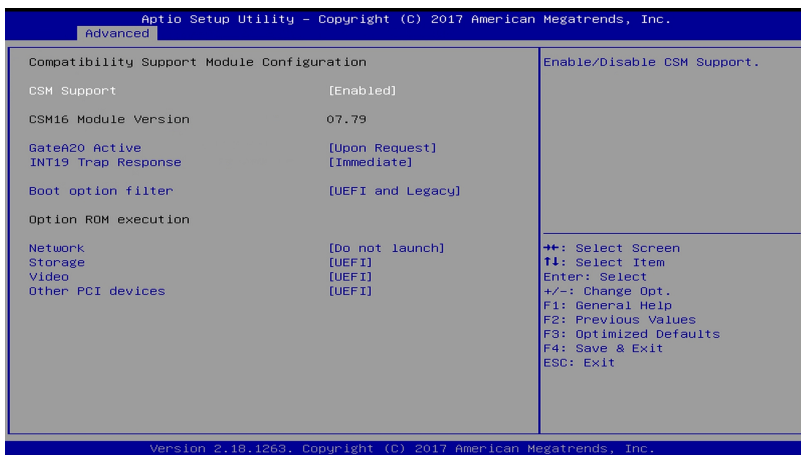

BIOS Setting	Description
CSM Support	Enables / Disables CSM support.
GateA20 Active	<ul style="list-style-type: none"> <li>• <b>Upon Request</b> disables GA20 when using BIOS services.</li> <li>• <b>Always</b> cannot disable GA20, but is useful when any RT code is executed above 1 MB.</li> </ul>
INT19 Trap Response	<p>Sets how BIOS reacts on INT19 trap by Option ROM.</p> <ul style="list-style-type: none"> <li>• <b>Immediate</b> executes the trap right away.</li> <li>• <b>Postponed</b> executes the trap during legacy boot.</li> </ul>
Boot option filter	Controls the priority of Legacy and UEFI ROMs.
Network	Controls the execution of UEFI and Legacy PXE OpROM.
Storage	Controls the execution of UEFI and Legacy Storage OpROM.
Video	Controls the execution of UEFI and Legacy Video OpROM.
Other PCI devices	Determines OpROM execution policy for devices other than network, storage or video.

## 4.4.10 USB Configuration

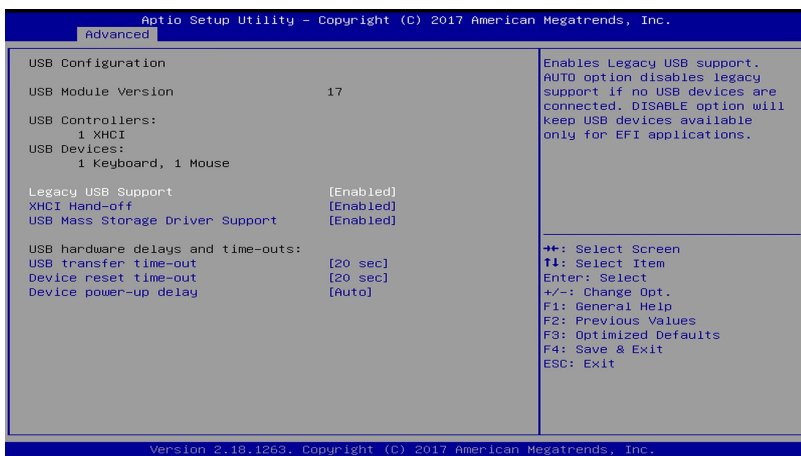

BIOS Setting	Description
Legacy USB Support	<ul style="list-style-type: none"> <li>• <b>Enabled</b> enables Legacy USB support.</li> <li>• <b>Auto</b> disables legacy support if there is no USB device connected.</li> <li>• <b>Disabled</b> keeps USB devices available only for EFI applications.</li> </ul>
XHCI Hand-off	This is a workaround for OSeS without XHCI hand-off support. The XHCI ownership change should be claimed by XHCI driver.
USB Mass Storage Driver Support	Enables / Disables the support for USB mass storage driver.
USB Transfer time-out	The time-out value (1 / 5 10 / 20 secs) for Control, Bulk, and Interrupt transfers.
Device reset time-out	Gives seconds (10 / 20 / 30 / 40 secs) to delay execution of Start Unit command to USB mass storage device.
Device power-up delay	The maximum time the device will take before it properly reports itself to the Host Controller. <b>Auto</b> uses default value for a Root port it is 100ms. But for a Hub port, the delay is taken from Hub descriptor.

## 4.5 Chipset Settings



### 4.5.1 North Bridge



BIOS Setting	Description
Max TOLUD	Sets a maximum value of TOLUD.

## 4.5.2 South Cluster Configuration

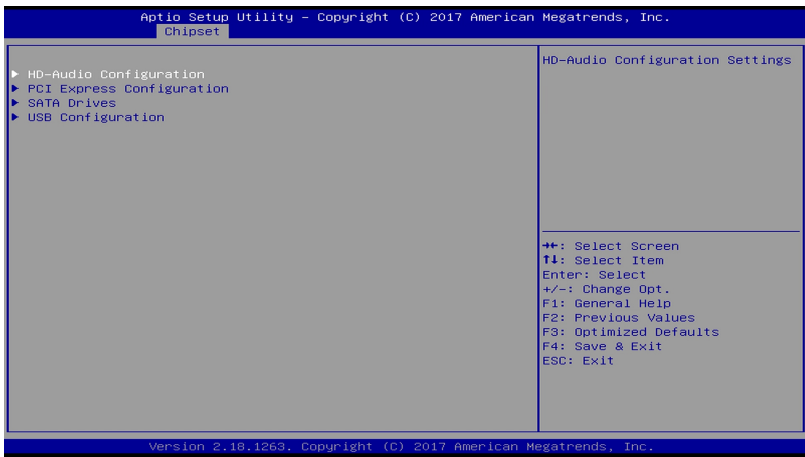

### 4.5.2.1 HD Audio Configuration

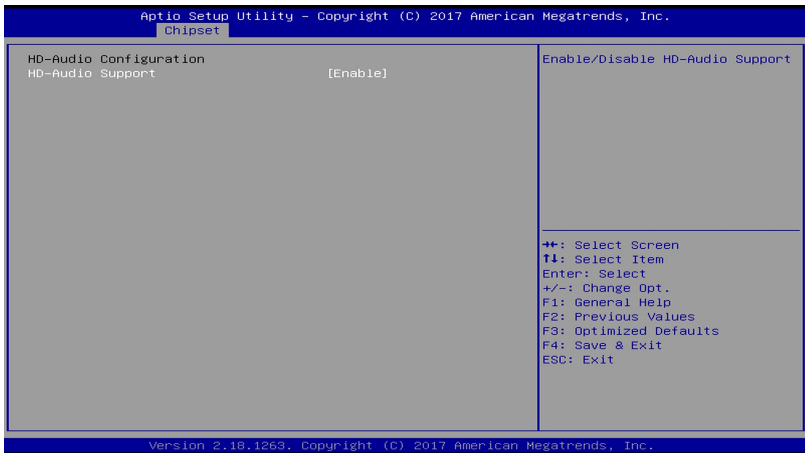

BIOS Setting	Description
HD-Audio Support	Enables / Disables HD-Audio support.

### 4.5.2.2. PCI Express Configuration

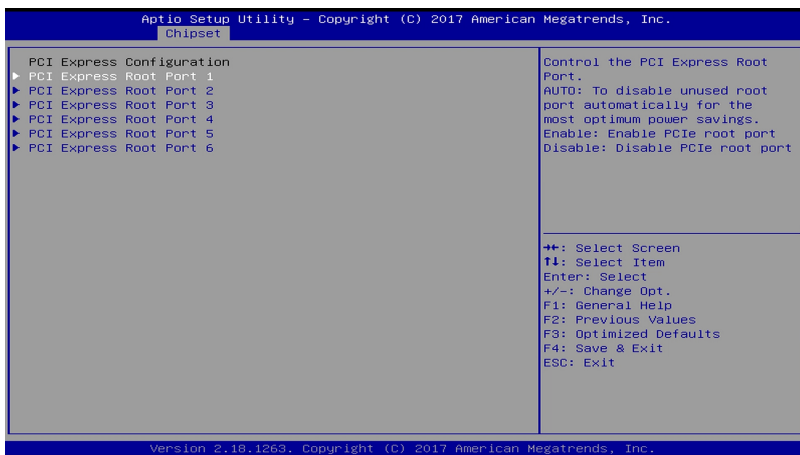

BIOS Setting	Description
PCI Express Root Port 1 ~ 6	Accesses the control of the PCI Express Root Port.

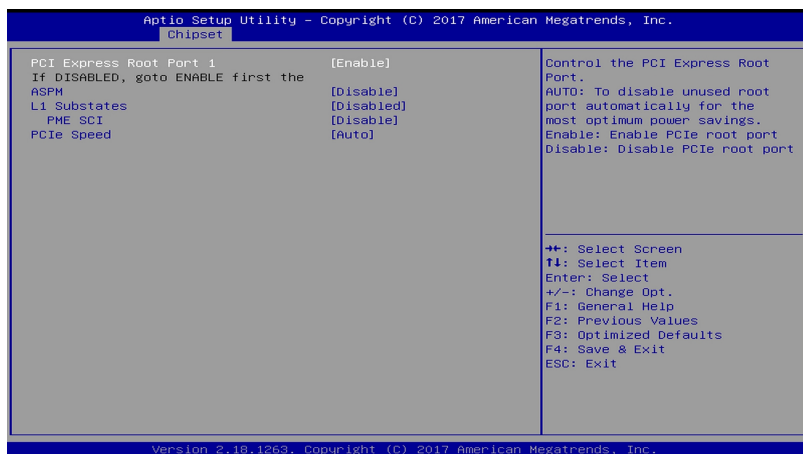

BIOS Setting	Description
PCI Express Root Port	Enables/ Disables the PCIe root port. <b>Auto</b> allows you to disable unused root port automatically for the most optimum power savings.
ASPM	Sets the PCIe active state power management. Options: Disable / L0s / L1 / L0SL1 / Auto
L1 Substates	Sets PCIe L1 substates. Options: Disables / L1.1 / L1.2 / L1.1 & L1.2
PME SCI	Enables / Disables PME SCI.
PCIe Speed	Configures the PCIe speed. Options: Auto, Gen1, Gen2



### 4.5.2.3. SATA Drivers

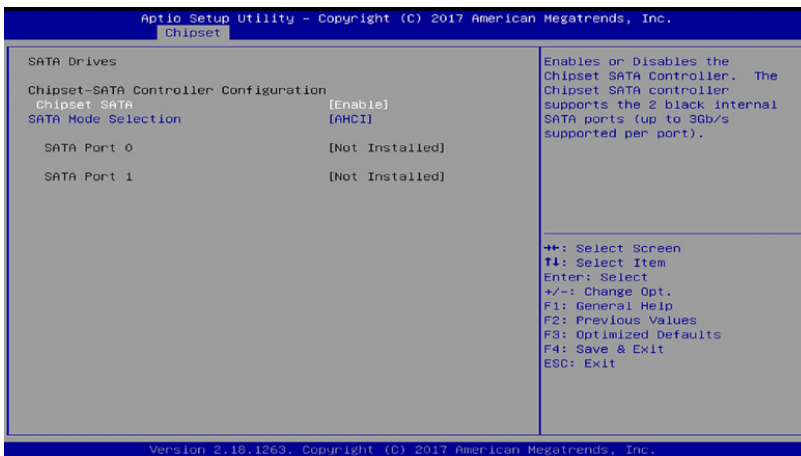

BIOS Setting	Description
Chipset SATA	Enables / Disables the Chipset SATA Controller. The Chipset SATA Controller supports the 2 black internal SATA ports (up to 3Gb/s supported per port).
SATA Mode Selection	Determines how SATA controller(s) operate.

## 4.5.2.4. USB Configuration

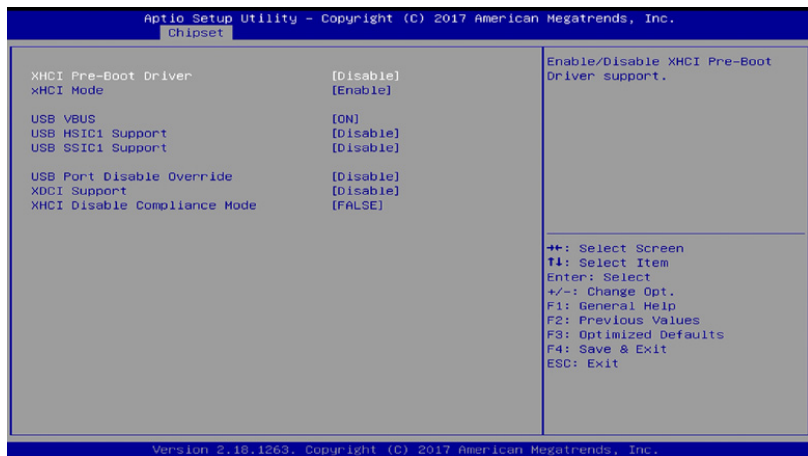

BIOS Setting	Description
XHCI Pre-Boot Driver	Enables / Disables the support for XHCI Pre-Boot Driver.
XHCI Mode	<p>Enables / Disables XHCI mode. If disabled, XHCI controller would be disabled, and none of the USB devices are detectable or usable when system is booted up in OS.</p> <p>Do NOT disable it unless for debug purpose.</p>
USB VBUS	VBUS should be ON in HOST mode. It should be OFF in OTG device mode.
USB HSIC1 Support	Enables / Disables USB HSIC1.
USB SSIC1 Support	Enables / Disables USB SSIC1.
USB Port Disable Override	Selectively enables / disables the corresponding USB port from reporting a device connection to the controller.
XDCI Support	Enables / Disables XDCI.
XHCI Disable Compliance Mode	<p><b>FALSE</b> makes the XHCI Link Compliance Mode not disabled.</p> <p><b>TRUE</b> disables the XHCI Link Compliance Mode.</p>

## 4.6 Security Settings



BIOS Setting	Description
Setup Administrator Password	Sets an administrator password for the setup utility.
User Password	Sets a user password.

## 4.7 Boot Settings

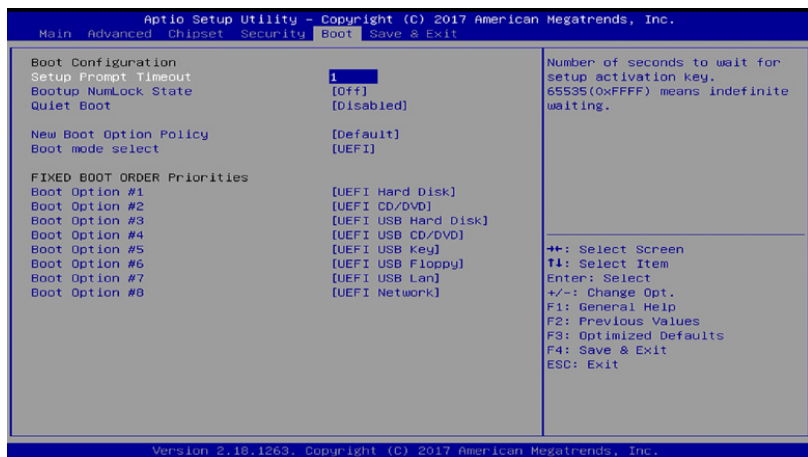

BIOS Setting	Description
Setup Prompt Timeout	Number of seconds to wait for setup activation key. 65535 (0xFFFF) means indefinite waiting.
Bootup NumLock State	Selects the keyboard NumLock state.
Quiet Boot	Enables / Disables Quiet Boot option.
New Boot Option Policy	Controls the placement of newly detected UEFI boot options. Options: Default, Place First, Place Last
Boot mode select	Selects a Boot mode, Legacy / UEFI / Dual.
Boot Option Priorities	Sets the system boot order priorities for hard disk, CD/DVD, USB, Network.

## 4.8 Save & Exit Settings



BIOS Setting	Description
Save Changes and Exit	Exits system setup after saving the changes.
Discard Changes and Exit	Exits system setup without saving any changes.
Save Changes and Reset	Resets the system after saving the changes.
Discard Changes and Reset	Resets system setup without saving any changes.
Save Changes	Saves changes done so far to any of the setup options.
Discard Changes	Discards changes done so far to any of the setup options.
Restore Defaults	Restores / Loads defaults values for all the setup options.
Save as User Defaults	Saves the changes done so far as User Defaults.
Restore User Defaults	Restores the user defaults to all the setup options.

This page is intentionally left blank.

# Appendix

This section provides the mapping addresses of peripheral devices and the sample code of watchdog timer configuration.

## A. I/O Port Address Map

Each peripheral device in the system is assigned a set of I/O port addresses which also becomes the identity of the device. The following table lists the I/O port addresses used.

Address	Device Description
0x00000A00-0x00000A0F	Motherboard resources
0x00000A10-0x00000A1F	Motherboard resources
0x00000A20-0x00000A2F	Motherboard resources
0x0000002E-0x0000002F	Motherboard resources
0x0000004E-0x0000004F	Motherboard resources
0x00000061-0x00000061	Motherboard resources
0x00000063-0x00000063	Motherboard resources
0x00000065-0x00000065	Motherboard resources
0x00000067-0x00000067	Motherboard resources
0x00000070-0x00000070	Motherboard resources
0x00000070-0x00000070	System CMOS/real time clock
0x00000080-0x0000008F	Motherboard resources
0x00000092-0x00000092	Motherboard resources
0x000000B2-0x000000B3	Motherboard resources
0x00000680-0x0000069F	Motherboard resources
0x00000400-0x0000047F	Motherboard resources
0x00000500-0x000005FE	Motherboard resources
0x00000600-0x0000061F	Motherboard resources
0x0000164E-0x0000164F	Motherboard resources
0x0000F040-0x0000F05F	Intel(R) Celeron(R)/Pentium(R) Processor SMBUS - 5AD4
0x0000D000-0x0000DFFF	Intel(R) Celeron(R)/Pentium(R) Processor PCI Express Root Port - 5AD9
0x000003F8-0x000003FF	Communications Port (COM1)
0x000002F8-0x000002FF	Communications Port (COM2)



0x000003E8-0x000003EF	Communications Port (COM3)
0x000002E8-0x000002EF	Communications Port (COM4)
0x0000E000-0x0000EFFF	Intel(R) Celeron(R)/Pentium(R) Processor PCI Express Root Port - 5AD8
0x00000000-0x0000006F	PCI Express Root Complex
0x00000078-0x00000CF7	PCI Express Root Complex
0x00000D00-0x0000FFFF	PCI Express Root Complex
0x00000020-0x00000021	Programmable interrupt controller
0x00000024-0x00000025	Programmable interrupt controller
0x00000028-0x00000029	Programmable interrupt controller
0x0000002C-0x0000002D	Programmable interrupt controller
0x00000030-0x00000031	Programmable interrupt controller
0x00000034-0x00000035	Programmable interrupt controller
0x00000038-0x00000039	Programmable interrupt controller
0x0000003C-0x0000003D	Programmable interrupt controller
0x000000A0-0x000000A1	Programmable interrupt controller
0x000000A4-0x000000A5	Programmable interrupt controller
0x000000A8-0x000000A9	Programmable interrupt controller
0x000000AC-0x000000AD	Programmable interrupt controller
0x000000B0-0x000000B1	Programmable interrupt controller
0x000000B4-0x000000B5	Programmable interrupt controller
0x000000B8-0x000000B9	Programmable interrupt controller
0x000000BC-0x000000BD	Programmable interrupt controller
0x000004D0-0x000004D1	Programmable interrupt controller
0x0000F000-0x0000F03F	Intel(R) HD Graphics
0x0000F090-0x0000F097	Standard SATA AHCI Controller
0x0000F080-0x0000F083	Standard SATA AHCI Controller
0x0000F060-0x0000F07F	Standard SATA AHCI Controller
0x00000040-0x00000043	System timer
0x00000050-0x00000053	System timer

## B. Interrupt Request Lines (IRQ)

Peripheral devices use interrupt request lines to notify CPU for the service required. The following table shows the IRQ used by the devices on board.

Level	Function
IRQ 25	High Definition Audio Controller
IRQ 4294967280 ~ IRQ 4294967285	Intel(R) I210 Gigabit Network Connection
IRQ 8	High precision event timer
IRQ 4	Communications Port (COM1)
IRQ 3	Communications Port (COM2)
IRQ 5	Communications Port (COM3)
IRQ 10	Communications Port (COM4)
IRQ 4294967279	Intel(R) USB 3.0 eXtensible Host Controller - 1.0 (Microsoft)
IRQ 54 ~ IRQ 511	Microsoft ACPI-Compliant System
IRQ 4294967292	Intel(R) Trusted Execution Engine Interface
IRQ 4294967293	Intel(R) HD Graphics
IRQ 14	Intel(R) Serial IO GPIO Host Controller - INT3452
IRQ 4294967294	Standard SATA AHCI Controller
IRQ 4294967286 ~ IRQ 4294967291	Intel(R) I210 Gigabit Network Connection #2
IRQ 0	System timer

## C. Watchdog Timer Configuration

The Watchdog Timer (WDT) is used to generate a variety of output signals after a user programmable count. The WDT is suitable for use in the prevention of system lock-up, such as when software becomes trapped in a deadlock. Under these sorts of circumstances, the timer will count to zero and the selected outputs will be driven.

Under normal circumstance, you will need to restart the WDT at regular intervals before the timer counts to zero.

### Sample Code:

```
//-----
//
// THIS CODE AND INFORMATION IS PROVIDED "AS IS" WITHOUT WARRANTY OF ANY
// KIND, EITHER EXPRESSED OR IMPLIED, INCLUDING BUT NOT LIMITED TO THE
// IMPLIED WARRANTIES OF MERCHANTABILITY AND/OR FITNESS FOR A PARTICULAR
// PURPOSE.
//
//-----
#include <dos.h>
#include <conio.h>
#include <stdio.h>
#include <stdlib.h>
#include "F81964.H"
//-----
int main (int argc, char*argv[]);
void EnableWDT(int);
void DisableWDT(void);
//-----
int main (int argc, char *argv[])
{
    unsigned char bBuf;
    unsigned char bTime;
    char **endptr;

    char SIO;

    printf("Fintek 81964 watch dog program\n");
    SIO = Init_F81964();
    if (SIO == 0)
    {
        printf("Can not detect Fintek 81964, program abort.\n");
        return(1);
    }
    //if (SIO == 0)

    if (argc != 2)
    {
        printf("Parameter incorrect!!\n");
        return (1);
    }
}
```

```

bTime = strtol( argv[1], endptr, 10);
printf("System will reset after %d seconds\n", bTime);

if (bTime)
{
    EnableWDT(bTime);
}
else
{
    DisableWDT();
}
return 0;
}
//-----
void EnableWDT(int interval)
{
    unsigned char bBuf;

    bBuf = Get_F81964_Reg(0x2B);
    bBuf &= (~0x20);
    Set_F81964_Reg(0x2B, bBuf);           //Enable WDTO

    Set_F81964_LD(0x07);                 //switch to logic device 7
    Set_F81964_Reg(0x30, 0x01);         //enable timer

    bBuf = Get_F81964_Reg(0xF5);
    bBuf &= (~0x0F);
    bBuf |= 0x52;
    Set_F81964_Reg(0xF5, bBuf);         //count mode is second

    Set_F81964_Reg(0xF6, interval);     //set timer

    bBuf = Get_F81964_Reg(0xFA);
    bBuf |= 0x01;
    Set_F81964_Reg(0xFA, bBuf);         //enable WDTO output

    bBuf = Get_F81964_Reg(0xF5);
    bBuf |= 0x20;
    Set_F81964_Reg(0xF5, bBuf);         //start counting
}
//-----
void DisableWDT(void)
{
    unsigned char bBuf;

    Set_F81964_LD(0x07);                 //switch to logic device 7

    bBuf = Get_F81964_Reg(0xFA);
    bBuf &= ~0x01;
    Set_F81964_Reg(0xFA, bBuf);         //disable WDTO output

    bBuf = Get_F81964_Reg(0xF5);
    bBuf &= ~0x20;
    bBuf |= 0x40;
    Set_F81964_Reg(0xF5, bBuf);         //disable WDT
}
//-----
//-----

```

```

//
// THIS CODE AND INFORMATION IS PROVIDED "AS IS" WITHOUT WARRANTY OF ANY
// KIND, EITHER EXPRESSED OR IMPLIED, INCLUDING BUT NOT LIMITED TO THE
// IMPLIED WARRANTIES OF MERCHANTABILITY AND/OR FITNESS FOR A PARTICULAR
// PURPOSE.
//
//-----
#include "F81964.H"
#include <dos.h>
//-----
unsigned int F81964_BASE;
void Unlock_F81964 (void);
void Lock_F81964 (void);
//-----
unsigned int Init_F81964(void)
{
    unsigned int result;
    unsigned char ucDid;

    F81964_BASE = 0x4E;
    result = F81964_BASE;

    ucDid = Get_F81964_Reg(0x20);
    if (ucDid == 0x07) //Fintek 81964
    {
        goto Init_Finish;
    }

    F81964_BASE = 0x2E;
    result = F81964_BASE;

    ucDid = Get_F81964_Reg(0x20);
    if (ucDid == 0x07) //Fintek 81964
    {
        goto Init_Finish;
    }

    F81964_BASE = 0x00;
    result = F81964_BASE;

Init_Finish:
    return (result);
}
//-----
void Unlock_F81964 (void)
{
    outputb(F81964_INDEX_PORT, F81964_UNLOCK);
    outputb(F81964_INDEX_PORT, F81964_UNLOCK);
}
//-----
void Lock_F81964 (void)
{
    outputb(F81964_INDEX_PORT, F81964_LOCK);
}
//-----
void Set_F81964_LD( unsigned char LD)
{
    Unlock_F81964();
    outputb(F81964_INDEX_PORT, F81964_REG_LD);
    outputb(F81964_DATA_PORT, LD);
    Lock_F81964();
}

```

```
}
//-----
void Set_F81964_Reg( unsigned char REG, unsigned char DATA)
{
    Unlock_F81964();
    outputb(F81964_INDEX_PORT, REG);
    outputb(F81964_DATA_PORT, DATA);
    Lock_F81964();
}
//-----

unsigned char Get_F81964_Reg(unsigned char REG)
{
    unsigned char Result;
    Unlock_F81964();
    outputb(F81964_INDEX_PORT, REG);
    Result = inputb(F81964_DATA_PORT);
    Lock_F81964();
    return Result;
}
//-----

//-----
//
// THIS CODE AND INFORMATION IS PROVIDED "AS IS" WITHOUT WARRANTY OF ANY
// KIND, EITHER EXPRESSED OR IMPLIED, INCLUDING BUT NOT LIMITED TO THE
// IMPLIED WARRANTIES OF MERCHANTABILITY AND/OR FITNESS FOR A PARTICULAR
// PURPOSE.
//
//-----
#ifndef F81964_H
#define F81964_H                1
//-----
#define F81964_INDEX_PORT      (F81964_BASE)
#define F81964_DATA_PORT      (F81964_BASE+1)
//-----
#define F81964_REG_LD          0x07
//-----
#define F81964_UNLOCK          0x87
#define F81964_LOCK            0xAA
//-----
unsigned int Init_F81964(void);
void Set_F81964_LD( unsigned char);
void Set_F81964_Reg( unsigned char,
unsigned char); unsigned char
Get_F81964_Reg( unsigned char);
//-----
#endif // F81964_H
```

## D. Onboard Connector Types

Function	Connector Name	Onboard Type	Compatible Mating Type for Reference
LCD Backlight	J3,J6	E-CALL 0110-161-040	JST PHR-4
LVDS	CH1: J4, CH2: J1, CH1: J5, CH2: J2	HIROSE DF20G-20DP-1V(56)	HRS DF20A-20DS-1C
Audio	J23	HK DF11-12S-PA66H	HRS DF11-12DS-2C
Amplifier	J24	E-CALL 0110-161-040	JST PHR-4
USB 2.0	J10	HK DF11-8S-PA66H	HRS DF11-8DS-2C
SATA HDD Power	J12	E-CALL 0110-071-040	JST XHP-4
COM2 / COM3 / COM4 RS-232	J18, J19, J14	HK DF11-10S-PA66H	HRS DF11-10DS-2C
Front Panel	J16	E-CALL 0126-01-203-080	Dupont 2.54 2*4Pin
COM Digital I/O	J22	E-CALL 0196-01-200-100	Dupont 2.0 2*5Pin
DC Power Input	J21	HK WAFER396-2S-WV	JST VHR-2N