

3.5"-SBC-TGL

Doc. User Guide, Rev. 1.6

Doc. ID: [To be Determined]

This page has been intentionally left blank

▶ 3.5"-SBC-TGL - USER GUIDE

Disclaimer

Kontron would like to point out that the information contained in this user guide may be subject to alteration, particularly as a result of the constant upgrading of Kontron products. This document does not entail any guarantee on the part of Kontron with respect to technical processes described in the user guide or any product characteristics set out in the user guide. Kontron assumes no responsibility or liability for the use of the described product(s), conveys no license or title under any patent, copyright or mask work rights to these products and makes no representations or warranties that these products are free from patent, copyright or mask work right infringement unless otherwise specified. Applications that are described in this user guide are for illustration purposes only. Kontron makes no representation or warranty that such application will be suitable for the specified use without further testing or modification. Kontron expressly informs the user that this user guide only contains a general description of processes and instructions which may not be applicable in every individual case. In cases of doubt, please contact Kontron.

This user guide is protected by copyright. All rights are reserved by Kontron. No part of this document may be reproduced, transmitted, transcribed, stored in a retrieval system, or translated into any language or computer language, in any form or by any means (electronic, mechanical, photocopying, recording, or otherwise), without the express written permission of Kontron. Kontron points out that the information contained in this user guide is constantly being updated in line with the technical alterations and improvements made by Kontron to the products and thus this user guide only reflects the technical status of the products by Kontron at the time of publishing.

Brand and product names are trademarks or registered trademarks of their respective owners.

©2023 by Kontron Europe GmbH

Kontron Europe GmbH

Gutenbergstraße 2
85737 Ismaning
Germany
www.kontron.com

Intended Use

THIS DEVICE AND ASSOCIATED SOFTWARE ARE NOT DESIGNED, MANUFACTURED OR INTENDED FOR USE OR RESALE FOR THE OPERATION OF NUCLEAR FACILITIES, THE NAVIGATION, CONTROL OR COMMUNICATION SYSTEMS FOR AIRCRAFT OR OTHER TRANSPORTATION, AIR TRAFFIC CONTROL, LIFE SUPPORT OR LIFE SUSTAINING APPLICATIONS, WEAPONS SYSTEMS, OR ANY OTHER APPLICATION IN A HAZARDOUS ENVIRONMENT, OR REQUIRING FAIL-SAFE PERFORMANCE, OR IN WHICH THE FAILURE OF PRODUCTS COULD LEAD DIRECTLY TO DEATH, PERSONAL INJURY, OR SEVERE PHYSICAL OR ENVIRONMENTAL DAMAGE (COLLECTIVELY, "HIGH RISK APPLICATIONS").

You understand and agree that your use of Kontron devices as a component in High Risk Applications is entirely at your risk. To minimize the risks associated with your products and applications, you should provide adequate design and operating safeguards. You are solely responsible for compliance with all legal, regulatory, safety, and security related requirements concerning your products. You are responsible to ensure that your systems (and any Kontron hardware or software components incorporated in your systems) meet all applicable requirements. Unless otherwise stated in the product documentation, the Kontron device is not provided with error-tolerance capabilities and cannot therefore be deemed as being engineered, manufactured or setup to be compliant for implementation or for resale as device in High Risk Applications. All application and safety related information in this document (including application descriptions, suggested safety measures, suggested Kontron products, and other materials) is provided for reference only.

Revision History

Revision	Brief Description of Changes	Date of Issue	Author/ Editor
1.0	Initial Issue	2021-Dec-28	YS
1.1	Add extended temperature	2022-May-06	YS
1.2	Modify CN9 Pin 1 voltage, GbE LED signal	2022-May-17	YS
1.3	Update LED2 color	2022-Sep-05	YS
1.4	Update LAN1 controller	2023-Mar-02	YS
1.5	Update Audio Codec	2023-Jun-20	YS
1.6	Update CN19 & CN20 mating connector	2023-Jun-27	YS

Terms and Conditions

Kontron warrants products in accordance with defined regional warranty periods. For more information about warranty compliance and conformity, and the warranty period in your region, visit <https://www.kontron.com/terms-and-conditions>.

Kontron sells products worldwide and declares regional General Terms & Conditions of Sale, and Purchase Order Terms & Conditions. Visit <https://www.kontron.com/terms-and-conditions>.

For contact information, refer to the corporate offices contact information on the last page of this user guide or visit our website [CONTACT US](#).

Customer Support

Find Kontron contacts by visiting: <https://www.kontron.com/support>.

Customer Service

As a trusted technology innovator and global solutions provider, Kontron extends its embedded market strengths into a services portfolio allowing companies to break the barriers of traditional product lifecycles. Proven product expertise coupled with collaborative and highly-experienced support enables Kontron to provide exceptional peace of mind to build and maintain successful products.

For more details on Kontron's service offerings such as: enhanced repair services, extended warranty, Kontron training academy, and more visit <https://www.kontron.com/support-and-services/services>.

Customer Comments

If you have any difficulties using this user guide, discover an error, or just want to provide some feedback, contact [Kontron support](#). Detail any errors you find. We will correct the errors or problems as soon as possible and post the revised user guide on our website.

Symbols

The following symbols may be used in this user guide

⚠ DANGER

DANGER indicates a hazardous situation which, if not avoided, will result in death or serious injury.

⚠ WARNING

WARNING indicates a hazardous situation which, if not avoided, could result in death or serious injury.

NOTICE

NOTICE indicates a property damage message.

⚠ CAUTION

CAUTION indicates a hazardous situation which, if not avoided, may result in minor or moderate injury.



Electric Shock!

This symbol and title warn of hazards due to electrical shocks (> 60 V) when touching products or parts of products. Failure to observe the precautions indicated and/or prescribed by the law may endanger your life/health and/or result in damage to your material.



ESD Sensitive Device!

This symbol and title inform that the electronic boards and their components are sensitive to static electricity. Care must therefore be taken during all handling operations and inspections of this product in order to ensure product integrity at all times.



HOT Surface!

Do NOT touch! Allow to cool before servicing.



Laser!

This symbol inform of the risk of exposure to laser beam and light emitting devices (LEDs) from an electrical device. Eye protection per manufacturer notice shall review before servicing.



This symbol indicates general information about the product and the user guide.

This symbol also indicates detail information about the specific product configuration.



This symbol precedes helpful hints and tips for daily use.

For Your Safety

Your new Kontron product was developed and tested carefully to provide all features necessary to ensure its compliance with electrical safety requirements. It was also designed for a long fault-free life. However, the life expectancy of your product can be drastically reduced by improper treatment during unpacking and installation. Therefore, in the interest of your own safety and of the correct operation of your new Kontron product, you are requested to conform with the following guidelines.

High Voltage Safety Instructions

As a precaution and in case of danger, the power connector must be easily accessible. The power connector is the product's main disconnect device.

CAUTION

Warning

All operations on this product must be carried out by sufficiently skilled personnel only.

CAUTION



Electric Shock!

Before installing a non hot-swappable Kontron product into a system always ensure that your mains power is switched off. This also applies to the installation of piggybacks. Serious electrical shock hazards can exist during all installation, repair, and maintenance operations on this product. Therefore, always unplug the power cable and any other cables which provide external voltages before performing any work on this product.

Earth ground connection to vehicle's chassis or a central grounding point shall remain connected. The earth ground cable shall be the last cable to be disconnected or the first cable to be connected when performing installation or removal procedures on this product.

Special Handling and Unpacking Instruction

NOTICE



ESD Sensitive Device!

Electronic boards and their components are sensitive to static electricity. Therefore, care must be taken during all handling operations and inspections of this product, in order to ensure product integrity at all times.

Do not handle this product out of its protective enclosure while it is not used for operational purposes unless it is otherwise protected.

Whenever possible, unpack or pack this product only at EOS/ESD safe work stations. Where a safe work station is not guaranteed, it is important for the user to be electrically discharged before touching the product with his/her hands or tools. This is most easily done by touching a metal part of your system housing.

It is particularly important to observe standard anti-static precautions when changing piggybacks, ROM devices, jumper settings etc. If the product contains batteries for RTC or memory backup, ensure that the product is not placed on conductive surfaces, including anti-static plastics or sponges. They can cause short circuits and damage the batteries or conductive circuits on the product.

Lithium Battery Precautions

If your product is equipped with a lithium battery, take the following precautions when replacing the battery.

CAUTION

Danger of explosion if the battery is replaced incorrectly.

- ▶ Replace only with same or equivalent battery type recommended by the manufacturer.
- ▶ Dispose of used batteries according to the manufacturer's instructions.

General Instructions on Usage

In order to maintain Kontron's product warranty, this product must not be altered or modified in any way. Changes or modifications to the product, that are not explicitly approved by Kontron and described in this user guide or received from Kontron Support as a special handling instruction, will void your warranty.

This product should only be installed in or connected to systems that fulfill all necessary technical and specific environmental requirements. This also applies to the operational temperature range of the specific board version that must not be exceeded. If batteries are present, their temperature restrictions must be taken into account.

In performing all necessary installation and application operations, only follow the instructions supplied by the present user guide.

Keep all the original packaging material for future storage or warranty shipments. If it is necessary to store or ship the product then re-pack it in the same manner as it was delivered.

Special care is necessary when handling or unpacking the product. See Special Handling and Unpacking Instruction.

Quality and Environmental Management

Kontron aims to deliver reliable high-end products designed and built for quality, and aims to complying with environmental laws, regulations, and other environmentally oriented requirements. For more information regarding Kontron's quality and environmental responsibilities, visit <https://www.kontron.com/about-kontron/corporate-responsibility/quality-management>.

Disposal and Recycling

Kontron's products are manufactured to satisfy environmental protection requirements where possible. Many of the components used are capable of being recycled. Final disposal of this product after its service life must be accomplished in accordance with applicable country, state, or local laws or regulations.

WEEE Compliance

The Waste Electrical and Electronic Equipment (WEEE) Directive aims to:

- ▶ Reduce waste arising from electrical and electronic equipment (EEE)
- ▶ Make producers of EEE responsible for the environmental impact of their products, especially when the product become waste
- ▶ Encourage separate collection and subsequent treatment, reuse, recovery, recycling and sound environmental disposal of EEE
- ▶ Improve the environmental performance of all those involved during the lifecycle of EEE



Environmental protection is a high priority with Kontron.

Kontron follows the WEEE directive

You are encouraged to return our products for proper disposal.

Table of Contents

Symbols	6
For Your Safety	7
High Voltage Safety Instructions	7
Special Handling and Unpacking Instruction	7
Lithium Battery Precautions	8
General Instructions on Usage	8
Quality and Environmental Management	8
Disposal and Recycling	8
WEEE Compliance	8
Table of Contents	9
List of Tables	10
List of Figures	11
1/ Introduction	13
2/ Installation Procedures	14
2.1. Installing the Board	14
2.2. Chassis Safety Standards	15
2.3. Lithium Battery Replacement	15
3/ System Specifications	16
3.1. System Block Diagram	16
3.2. Component Main Data	17
3.3. Environmental Conditions	18
3.4. Standards and Certifications	19
3.5. Processor Support	20
3.6. System Memory Support	20
3.6.1. Memory Operating Frequencies	20
3.7. On-board Graphics Subsystem	21
3.8. Power Supply Voltage	22
4/ Connector Locations	23
4.1. Top Side	23
4.2. Rear Side	25
4.3. Connector Panel Side	26
5/ Connector Definitions	27
6/ I/O-Area Connectors	28
6.1. DP Connector (CN21 & CN22)	28
6.2. Ethernet Connectors (CN15 & CN16)	29
6.3. USB Connectors (I/O Area)	31
6.4. Power Button (SW1)	33
6.5. LED Indicators (LED1 & LED2)	33
7/ Internal Connectors	34
7.1. Power Connector	34
7.1.1. Power Input Wafer (CN12)	34
7.1.2. RTC Power Input Wafer (CN26)	35
7.2. Fan Wafer (CN4)	36
7.3. SATA (Serial ATA) Port 0 Connector (CN27)	37
7.4. SATA Power Output Wafer (CN9)	38
7.5. USB Connectors (Internal) (CN19 & CN20)	39

7.6. Audio AMP Output Wafer (CN1 & CN5)	40
7.7. Audio Input / Output Header (CN7).....	41
7.8. Front Panel Header (FP1 & FP2).....	42
7.9. Serial COM1 & COM2 Ports (CN24 & CN23).....	44
7.10. LVDS Connector (CN25).....	46
7.11. LVDS Backlight Power Wafer (CN2)	48
7.12. Digital Input / Output Header (CN3).....	49
7.13. M.2 Key B 2242 / 3042 / 2280 Slot (M2B1).....	50
7.14. M.2 Key E 2230 Slot (M2E1)	53
7.15. M.2 Key M 2280 Slot (M2M1)	56
7.16. Micro SIM Card Holder for M.2 Key B (CN6)	59
7.17. M.2 Key B / M.2 Key E / M.2 Key M Activity Indicator Header (CN8, CN11 & CN14).....	60
7.18. Extended B2B Connector (CN28)	61
7.19. Switches and Jumpers.....	65
7.19.1. LVDS Backlight Control Selection (JP1).....	65
7.19.2. M.2 Key B Selection (JP2)	66
7.19.3. LVDS Panel Power Selection (JP3).....	66
7.19.4. LVDS Backlight Enable Selection (JP4).....	67
7.19.5. LVDS Backlight Enable Voltage Selection (JP5).....	67
7.19.6. Flash Descriptor Security Override Selection (JP6)	68
7.19.7. AT / ATX Power Mode Selection (JP7).....	68
7.19.8. Clear CMOS Selection (JP8).....	69
7.19.9. MFG Mode Selection (JP9)	69
7.19.10. USB Power Selection (JP10).....	70
8/ BIOS.....	71
8.1. Starting the uEFI BIOS	71
8.2. Starting the uEFI BIOS	72
8.2.1. Main Setup Menu	72
8.2.2. Advanced Setup Menu.....	74
8.2.3. Power Setup Menu.....	92
8.2.4. Boot Setup Menu	94
8.2.5. Security Setup Menu	95
8.2.6. Save & Exit Setup Menu	100
Appendix A: List of Acronyms	101
About Kontron	102

List of Tables

Table 1: Component Main Data	17
Table 2: Environmental Conditions	18
Table 3: Standards and Certifications	19
Table 4: Processor Support.....	20
Table 5: Memory Operating Frequencies.....	20
Table 6: Quadruple-displays Configurations	21
Table 7: Supply Voltages	22
Table 8: Jumper List.....	23
Table 9: Top Side Internal Connector Pin Assignment.....	23
Table 10: Rear Side Internal Connector Pin Assignment.....	25
Table 11: Connector Panel Side Connector List	26
Table 12: Pin Assignment DP Connector CN21, CN22.....	28

Table 13: Pin Assignment Ethernet Connectors CN15, CN16	29
Table 14: Pin Assignment USB 3.2 Gen 2 / USB 2.0 Connectors CN17 - Top & Bottom, CN18 - Top & Bottom	31
Table 15: LED Indicators LED1, LED2	33
Table 16: Pin Assignment CN12	34
Table 17: Pin Assignment CN26	35
Table 18: Pin Assignment CN4	36
Table 19: Pin Assignment CN27	37
Table 20: Pin Assignment CN9	38
Table 21: Pin Assignment CN19, CN20	39
Table 22: Pin Assignment CN1, CN5	40
Table 23: Pin Assignment CN7	41
Table 24: Pin Assignment FP1	42
Table 25: Pin Assignment FP2	42
Table 26: Pin Assignment CN23, CN24	44
Table 27: Signal Description	44
Table 28: Pin Assignment CN25	46
Table 29: Pin Assignment CN2	48
Table 30: Pin Assignment CN3	49
Table 31: Pin Assignment M2B1	50
Table 32: Pin Assignment M2E1	53
Table 33: Pin Assignment M2M1	56
Table 34: Pin Assignment CN6	59
Table 35: Pin Assignment CN8, CN14	60
Table 36: Pin Assignment CN11	60
Table 37: Pin Assignment CN28	61
Table 38: Pin Assignment JP1	65
Table 39: Pin Assignment JP2	66
Table 40: Pin Assignment JP3	66
Table 41: Pin Assignment JP4	67
Table 42: Pin Assignment JP5	67
Table 43: Pin Assignment JP6	68
Table 44: Pin Assignment JP7	68
Table 45: Pin Assignment JP8	69
Table 46: Pin Assignment JP9	69
Table 47: Pin Assignment JP10	70
Table 48: Hotkeys Table	71
Table 49: Main Setup Menu Sub-Screens and Functions	72
Table 50: List of Acronyms	101

List of Figures

Figure 1: System Block Diagram 3.5"-SBC-TGL	16
Figure 2: Top Side	23
Figure 3: Rear Side	25
Figure 4: Connector Panel Side	26
Figure 5: DP Connector CN21, CN22	28
Figure 6: Ethernet Connector CN15	29
Figure 7: Ethernet Connector CN16	29
Figure 8: USB 3.2 Gen 2 Connectors CN17 - Top & Bottom, CN18 - Top & Bottom	31
Figure 9: USB 2.0 High Speed Cable	31
Figure 10: USB 3.2 High Speed Cable	32
Figure 11: Power Input Wafer CN12	34
Figure 12: RTC Power Input Wafer CN26	35
Figure 13: Fan Wafer CN4	36
Figure 14: SATA Port 0 Connector CN27	37
Figure 15: SATA Power Output Wafer CN9	38

Figure 16: USB 2.0 Port 5, 6 Pin Header CN19, Port 7, 8 Pin Header CN20	39
Figure 17: Audio AMP Output Wafer CN1 (Left Channel), CN5 (Right Channel)	40
Figure 18: Audio Input / Output Header CN7	41
Figure 19: Front Panel 1 Header FP1	42
Figure 20: Front Panel 2 Header FP2	42
Figure 21: Serial COM CN23, CN24	44
Figure 22: LVDS Connector CN25	46
Figure 23: LVDS Backlight Power Wafer CN2	48
Figure 24: Digital Input / Output Header CN3	49
Figure 25: M.2 Key B 3042 / 2280 Slot M2B1	50
Figure 26: M.2 Key E 2230 Slot M2E1	53
Figure 27: M.2 Key M 2280 Slot M2M1	56
Figure 28: Micro SIM Card Holder CN6	59
Figure 29: M.2 Key B / M.2 Key M Activity Indicator Header CN8, CN14	60
Figure 30: M.2 Key E Activity Indicator Header CN11	60
Figure 31: Extended B2B Connector CN28	61
Figure 32: Jumper Connector	65
Figure 33: LVDS Backlight Control Selection JP1	65
Figure 34: M.2 Key B Selection JP2	66
Figure 35: LVDS Panel Power Selection JP3	66
Figure 36: LVDS Backlight Enable Selection JP4	67
Figure 37: LVDS Backlight Enable Voltage Selection JP5	67
Figure 38: Flash Descriptor Security Override Selection JP6	68
Figure 39: AT / ATX Power Mode Selection JP7	68
Figure 40: Clear CMOS Selection JP8	69
Figure 41: MFG Mode Selection JP9	69
Figure 42: USB Power Selection JP10	70
Figure 43: BIOS Main Menu Screen System Data and Time	73
Figure 44: BIOS Advanced Menu	75
Figure 45: BIOS Advanced Menu - Display Configuration	76
Figure 46: BIOS Advanced Menu - CPU Chipset Configuration	78
Figure 47: BIOS Advanced Menu - NVMe Configuration	80
Figure 48: BIOS Advanced Menu - SATA Configuration	81
Figure 49: BIOS Advanced Menu - USB Configuration	82
Figure 50: BIOS Advanced Menu - AMT Configuration	83
Figure 51: BIOS Advanced Menu - Trusted Computing	84
Figure 52: BIOS Advanced Menu - DIO Configuration	85
Figure 53: BIOS Advanced Menu - Network Stack	86
Figure 54: BIOS Advanced Menu - Super IO Configuration	87
Figure 55: BIOS Advanced Menu - Super IO Configuration - Serial Port 1 Configuration	87
Figure 56: BIOS Advanced Menu - Super IO Configuration - Serial Port 2 Configuration	88
Figure 57: BIOS Advanced Menu - H/W Monitor	90
Figure 58: BIOS Advanced Menu - H/W Monitor - Smart FAN Configuration	90
Figure 59: BIOS Power Setup Menu	92
Figure 60: BIOS Power Setup Menu - WatchDog Timer Configuration	93
Figure 61: BIOS Boot Setup Menu	94
Figure 62: BIOS Security Setup Menu	95
Figure 63: BIOS Security Setup Menu - Secure Boot	96
Figure 64: BIOS Security Setup Menu - Secure Boot - Key Management	97
Figure 65: BIOS Save & Exit Setup Menu	100

1/ Introduction

This user guide describes the 3.5"-SBC-TGL board made by Kontron. This board will also be denoted 3.5"-SBC-TGL within this user guide.

Use of this user guide implies a basic knowledge of PC-AT hardware and software. This user guide focuses on describing the 3.5"-SBC-TGL board's special features and is not intended to be a standard PC-AT textbook.

New users are recommended to study the short installation procedure stated in the following chapter before switching on the power.

All configuration and setup of the CPU board is either carried out automatically or manually by the user via the BIOS setup menus.

Latest revision of this user guide, datasheet, thermal simulations, BIOS, drivers, BSP's (Board Support Packages), mechanical drawings (2D and 3D) can be downloaded from Kontron's Web Page.

2/ Installation Procedures

2.1. Installing the Board

NOTICE



ESD Sensitive Device!

Electrostatic discharge (ESD) can damage equipment and impair electrical circuitry.

- ▶ Wear ESD-protective clothing and shoes
- ▶ Wear an ESD-preventive wrist strap attached to a good earth ground
- ▶ Check the resistance value of the wrist strap periodically (1 MΩ to 10 MΩ)
- ▶ Transport and store the board in its antistatic bag
- ▶ Handle the board at an approved ESD workstation
- ▶ Handle the board only by the edges

To get the board running follow these steps. If the board shipped from KONTRON already has components like RAM and CPU cooler mounted, then skip the relevant steps below.

1. Turn off the PSU (Power Supply Unit)

NOTICE

Turn off PSU (Power Supply Unit) completely (no mains power connected to the PSU) or leave the Power Connectors unconnected while configuring the board. Otherwise, components (RAM, LAN cards etc.) might get damaged. Make sure to use +12 V DC single supply only with suitable cable kit and PS-ON# active.

NOTICE

The power supply unit shall comply with the requirements as defined in IEC 62368-1 according Clause 6.2.2 to power source category PS2 "Limited Power Source".

2. Insert the DDR4 3200 module(s)

Be careful to push the memory module(s) in the slot(s) before locking the tabs.

3. Connecting interfaces

Insert all external cables for hard disk, keyboard etc. A monitor must be connected in order to change BIOS settings.

4. Connect and turn on PSU

Connect PSU to the board by the +12 V 3.0 mm pitch 1x4-pin wafer connector.

5. BIOS setup

Enter the BIOS setup by pressing the key during boot up.

Enter "Exit Menu" and Load Setup Defaults.



To clear all BIOS setting, including Password protection, activate "Clear CMOS Jumper" for 10 sec (without power connected).

6. Mounting the board in chassis

NOTICE

When mounting the board to chassis etc. please note that the board contains components on both sides of the PCB that can easily be damaged if board is handled without reasonable care. A damaged component can result in malfunction or no function at all.

When fixing the board on a chassis, it is recommended to use screws with an integrated washer and a diameter of > 7 mm. Do not use washers with teeth, as they can damage the PCB and cause short circuits.

2.2. Chassis Safety Standards

Before installing the 3.5"-SBC-TGL in the chassis, users must evaluate the end product to ensure compliance with the requirements of the IEC60950-1 safety standard:

- ▶ The board must be installed in a suitable mechanical, electrical and fire enclosure.
- ▶ The system, in its enclosure, must be evaluated for temperature and airflow considerations.
- ▶ The board must be powered by a CSA or UL approved power supply that limits the maximum input current.
- ▶ For interfaces having a power pin such as external power or fan, ensure that the connectors and wires are suitably rated. All connections from and to the product shall be with SELV circuits only.
- ▶ Wires have suitable rating to withstand the maximum available power.
- ▶ The peripheral device enclosure fulfils the IEC60950-1 fire protecting requirements.

2.3. Lithium Battery Replacement

If replacing the lithium battery follow the replacement precautions stated in the notification below:

CAUTION

Danger of explosion if the lithium battery is incorrectly replaced.

- ▶ Replace only with the same or equivalent type recommended by the manufacturer
- ▶ Dispose of used batteries according to the manufacturer's instructions

VORSICHT! Explosionsgefahr bei unsachgemäßem Austausch der Batterie.

- ▶ Ersatz nur durch denselben oder einen vom Hersteller empfohlenen gleichwertigen Typ
- ▶ Entsorgung gebrauchter Batterien nach Angaben des Herstellers

ATTENTION! Risque d'explosion avec l'échange inadéquat de la batterie.

- ▶ Remplacement seulement par le même ou un type équivalent recommandé par le producteur
- ▶ L'évacuation des batteries usagées conformément à des indications du fabricant

PRECAUCION! Peligro de explosi3n si la bater3a se sustituye incorrectamente.

- ▶ Sustituya solamente por el mismo o tipo equivalente recomendado por el fabricante
- ▶ Disponga las bater3as usadas seg3n las instrucciones del fabricante

ADVARSEL! Lithiumbatteri – Eksplosjonsfare ved feilagtig h3ndtering.

- ▶ Udkiftning m3 kun ske med batteri af samme fabrikat og type
- ▶ Lev3r det brugte batteri tilbage til leverand3ren

ADVARSEL! Eksplosjonsfare ved feilaktig skifte av batteri.

- ▶ Benytt samme batteritype eller en tilsvarende type anbefalt av apparatfabrikanten
- ▶ Brukte batterier kasseres i henhold til fabrikantens instruksjoner

WARNING! Explosionsfara vid felaktigt batteribyte.

- ▶ Anv3nd samma batterityp eller en ekvivalent typ som rekommenderas av apparattillverkaren
- ▶ Kassera anv3nt batteri enligt fabrikantens instruktion

VAROITUS! Paristo voi r3j3ht33, jos se on virheellisesti asennettu.

- ▶ Vaihda paristo ainoastaan lalteil- mistajan suositteluun tyypill3n
 - ▶ H3vit3 k3ytetty paristo valmistajan ohjeiden mukaisesti
-

3/ System Specifications

3.1. System Block Diagram

Figure 1: System Block Diagram 3.5"-SBC-TGL

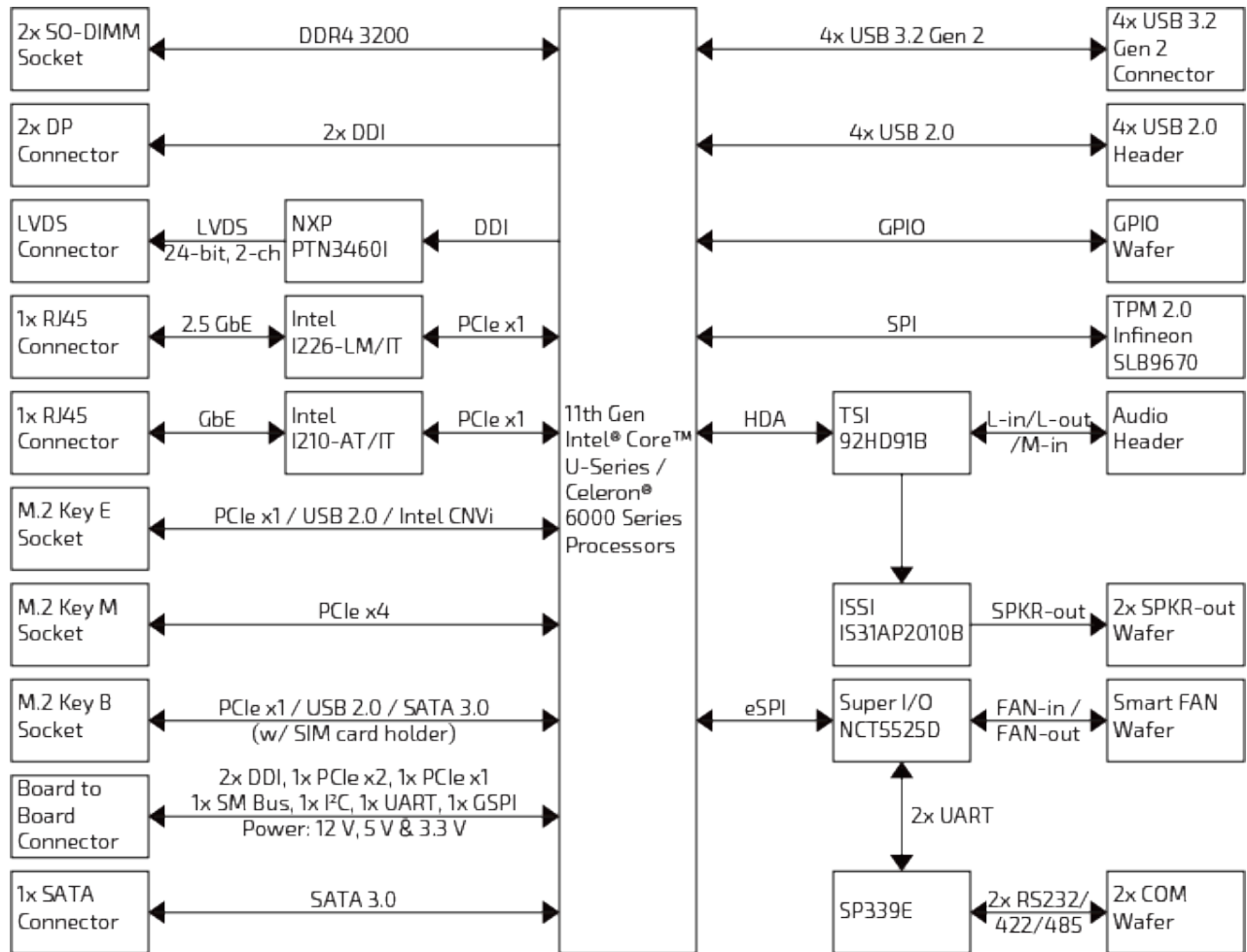

3.2. Component Main Data

The table below summarizes the features of the 3.5"-SBC-TGL single board computer.

Table 1: Component Main Data

System	
Processor	<ul style="list-style-type: none"> ▶ 11th Generation Intel® Core™ U-Series Processors ▶ Intel® Celeron® 6000 Series Processors
Memory	▶ 2x DDR4 SO-DIMM
Video	
Display Interface	<ul style="list-style-type: none"> ▶ 1x LVDS ▶ 2x DP (on rear)
Multiple Display	▶ Quadruple (more display I/Os supported via extended B2B connector)
Audio	
Audio Codec	▶ TSI 92HD91B
Audio Display	<ul style="list-style-type: none"> ▶ 2x Speaker-out (Right & Left, 3 W) ▶ 1x Line-in (by header) ▶ 1x Line-out (by header) ▶ 1x Mic-in (by header)
Network Connection	
Ethernet	<ul style="list-style-type: none"> ▶ 1x 2.5 GbE LAN (RJ45 on rear, Intel® I226-LM/IT) ▶ 1x GbE LAN (RJ45 on rear, Intel® I210-AT/IT)
Peripheral Connection	
USB	<ul style="list-style-type: none"> ▶ 4x USB 3.2 Gen 2 (Type A on rear) ▶ 4x USB 2.0 (by header)
Serial Port	▶ 2x RS232/422/485 (by header)
Other I/Os	▶ 8-bit DIO (by header)
Storage & Expansion	
SATA	▶ 1x SATA 3.0
M.2	<ul style="list-style-type: none"> ▶ 1x M.2 Key B (Type 2242 / 3042 / 2280, mixed w/ PCIe x1 / USB 2.0 / SATA 3.0) ▶ 1x M.2 Key E (Type 2230, mixed w/ PCIe x1 / USB 2.0 / UART / PCM, Intel® CNVi support) ▶ 1x M.2 Key M (Type 2280, mixed w/ PCIe x4)
SIM Card Holder	▶ 1x SIM Card Holder (Micro type, connected to M.2 Key B)
Extended B2B Connector	<ul style="list-style-type: none"> ▶ 2x DDI (1x eDP / DP support, 1x DP support) ▶ 1x PCIe x2 ▶ 1x PCIe x1 ▶ 1x SM Bus ▶ 1x I2C ▶ 1x UART ▶ 1x GSPI
Power	

System	
Input Voltage	▶ DC 12 V
Connector	▶ 1x4-pin pitch 3.0 mm Wafer
Firm ware	
BIOS	▶ AMI uEFI BIOS w/ 256 Mb SPI Flash
Watchdog	▶ Programmable WDT to generate system reset event
H/W Monitor	▶ Voltages ▶ Temperatures
Real Time Clock	▶ Processor integrated RTC
Security	▶ TPM 2.0 (Infineon SLB 9670)
System Control & Monitoring	
Front Panel Header	▶ 1x Header Reset Button, HDD LED & External Speaker ▶ 1x Header for Power Button, Power LED & SM bus ▶ 1x Header for M.2 Key B activity LED ▶ 1x Header for M.2 Key E activity LED
Button, Switch & Indicator	▶ 1x Standby LED (Yellow, on rear) ▶ 1x Power LED (Green, on rear) ▶ 1x Power Button (on rear)
Cooling	
Fan	▶ 1x Wafer for System Fan
Software	
OS Support	▶ Windows 10 ▶ Linux
Mechanical	
Dimension (L x W)	▶ ECX (146 mm x 105 mm / 5.75" x 4.13")

3.3. Environmental Conditions

The 3.5"-SBC-TGL is compliant with the following environmental conditions. It is the customer's responsibility to provide sufficient airflow around each of the components to keep them within the allowed temperature range.

Table 2: Environmental Conditions

Operating Temperature	▶ 0 °C ~ 60 °C / 32 °F ~ 140 °F (Standard) ▶ -20 °C ~ 70 °C / -4 °F ~ 158 °F (Extended) ▶ -40 °C ~ 85 °C / -40 °F ~ 185 °F (Extreme)
Storage Temperature	▶ -20 °C ~ 80 °C / -4 °F ~ 176 °F (Standard) ▶ -40 °C ~ 85 °C / -40 °F ~ 185 °F (Extended) ▶ -55 °C ~ 85 °C / -67 °F ~ 185 °F (Extreme)
Humidity	▶ 0 % ~ 95 %

3.4. Standards and Certifications

The 3.5"-SBC-TGL meets the following standards and certification tests.

Table 3: Standards and Certifications

CE Class B	<ul style="list-style-type: none"> ▶ EN 55032: 2015 + A1: 2020, Class B ▶ CISPR 32: 2015 ▶ EN 61000-3-2: 2014 ▶ EN 61000-3-3: 2013 ▶ EN 55024: 2010 + A1: 2015 ▶ IEC 61000-4-2: 2008 ▶ IEC 61000-4-3: 2006 + A1: 2007 + A2: 2010 ▶ IEC 61000-4-4: 2012 ▶ IEC 61000-4-5: 2014 + A1: 2017 ▶ IEC 61000-4-6: 2013 ▶ IEC 61000-4-8: 2009 ▶ IEC 61000-4-11: 2004 + A1: 2017
FCC Class B	<ul style="list-style-type: none"> ▶ FCC CFR Title 47 Part 15 Subpart B, Class B ▶ ICES-003 Issue 7: 2020 Class B ▶ ANSI C63.4: 2014 ▶ ANSI C63.4a: 2017

3.5. Processor Support

The 3.5"-SBC-TGL is designed to support 11th Generation Intel® Core™ U-Series and Intel® Celeron® 6000 Series Processors. The BGA CPU is remounted from factory. Kontron has defined the board versions as listed in the following table, so far all based on Embedded CPUs. Other versions are expected at a later date.

Table 4: Processor Support

Name	Core #	Speed (GHz)	Turbo (GHz)	Embdd.	Cache	Socket	TDP (W)	TDP-up (W)	TDP-down (W)	Tj (° C)
Core™ i7-1185GRE	4	1.80	4.40	Yes	12M	BGA1449	15	28	12	100
Core™ i7-1185G7E	4	1.80	4.40	Yes	12M	BGA1449	15	28	12	100
Core™ i5-1145GRE	4	1.50	4.10	Yes	8M	BGA1449	15	28	12	100
Core™ i5-1145G7E	4	1.50	4.10	Yes	8M	BGA1449	15	28	12	100
Core™ i3-1115G4E	2	2.20	3.90	Yes	6M	BGA1449	15	28	12	100
Celeron® 6305E	2	1.80	-	Yes	4M	BGA1449	15	-	-	100

Sufficient cooling must be applied to the CPU in order to remove the effect as listed as TDP (Thermal Design Power) in above table. The sufficient cooling is also depending on the worst case maximum ambient operating temperature and the actual worst case load of processor.

3.6. System Memory Support

The 3.5"-SBC-TGL has two DDR4 SO-DIMM sockets. The sockets support the following memory features:

- ▶ 2x DDR4 SO-DIMM 260-pin
- ▶ Dual-channel with 1x SO-DIMM per channel
- ▶ Up to 64 GB
- ▶ SPD timing supported
- ▶ ECC not supported

The installed DDR4 SO-DIMM should support the Serial Presence Detect (SPD) data structure. This allows the BIOS to read and configure the memory controller for optimal performance. If non-SPD memory is used, the BIOS will attempt to configure the memory settings, but performance and reliability may be impacted, or the board may not be able to boot totally.

3.6.1. Memory Operating Frequencies

In all modes, the frequency of system memory is the lowest frequency of all the memory modules placed in the system. Each memory module's frequency can be determined through the SPD registers on the memory modules.

The table below lists the resulting operating memory frequencies based on the combination of SO-DIMMs and processor.

Table 5: Memory Operating Frequencies

SO-DIMM Type	Module Name	Memory Data Transfer (MT/s)	Processor System Bus Frequency (MHz)	Resulting Memory Clock Frequency (MHz)	Peak Transfer Rate (MB/s)
DDR4 3200	PC4-25600	3200	1600	400	25600

Memory modules have in general a much lower longevity than embedded motherboards, and therefore EOL of modules can be expected several times during lifetime of the motherboard.

As a minimum it is recommend using Kontron memory modules for prototype system(s) in order to prove stability of the system and as for reference.

For volume production you might request to test and qualify other types of RAM. In order to qualify RAM it is recommend configuring 3 systems running RAM Stress Test program in heat chamber at 60° C for a minimum of 24 hours.

3.7. On-board Graphics Subsystem

The 3.5"-SBC-TGL supports either Intel® Iris® Xe Graphics integrated in Core™ i7 / i5 Series processors or Intel® UHD Graphics technology in Core™ i3 / Celeron® Series processors for high quality graphics capabilities. All 3.5"-SBC-TGL versions support quadruple displays pipes.

Quadruple displays can be used simultaneously and be used to implement independent or cloned display configuration.

The 3.5"-SBC-TGL itself provides one internal LVDS interface and two external DP connectors. It supports additional two DDI (Digital Display Interface) signals via the extended B2B connector (CN28). One DDI can support eDP or DP port; the other DDI can support DP port.

The model with Intel® Core™ i7 / i5 Series processors can support up to two 8K DP displays and that with Intel® Core™ i3 / Celeron® Series processors can support one 8K DP display.

Table 6: Quadruple-displays Configurations

No.	Display 1	Display 2	Display 3	Display 4
1	LVDS	DP	DP	DDIO
2	LVDS	DP	DP	DDI1
3	LVDS	DP	DDIO	DDI1
4	DP	DP	DDIO	DDI1
No.	Max. Resolution (Px) at 60 Hz			
	Display 1	Display 2	Display 3	Display 4
1	1920 x 1200	7680 x 4320 / 4096 x 2304*	7680 x 4320 / 4096 x 2304*	4096 x 2304 (eDP) 7680 x 4320 / 4096 x 2304* (DP)
2	1920 x 1200	7680 x 4320 / 4096 x 2304*	7680 x 4320 / 4096 x 2304*	7680 x 4320 / 4096 x 2304* (DP)
3	1920 x 1200	7680 x 4320 / 4096 x 2304*	4096 x 2304 (eDP) 7680 x 4320 / 4096 x 2304* (DP)	7680 x 4320 / 4096 x 2304* (DP)
4	7680 x 4320 / 4096 x 2304	7680 x 4320 / 4096 x 2304*	4096 x 2304 (eDP) 7680 x 4320 / 4096 x 2304* (DP)	7680 x 4320 / 4096 x 2304* (DP)



* The model with Intel® Core™ i7 / i5 Series processors can support up to two 8K DP displays and that with Intel® Core™ i3 / Celeron® Series processors can support one 8K DP display.

3.8. Power Supply Voltage

In order to ensure safe operation of the board, the input power supply must monitor the supply voltage and shut down if the supply is out of range – refer to the actual power supply specification. Please note, in order to keep the power consumption to a minimal level, boards do not implement a guaranteed minimum load. The 3.5"-SBC-TGL board must be powered through the 3.0 mm pitch 1x4-pin wafer connector from a DC 12 V power supply.

NOTICE

Hot Plugging power supply is not supported. Hot plugging might damage the board.

The requirements to the supply voltages are as follows:

Table 7: Supply Voltages

Supply	Min.	Max.	Note
+12 V	11.4 V	12.6 V	Should be $\pm 5\%$ tolerance

4/ Connector Locations

4.1. Top Side

Figure 2: Top Side

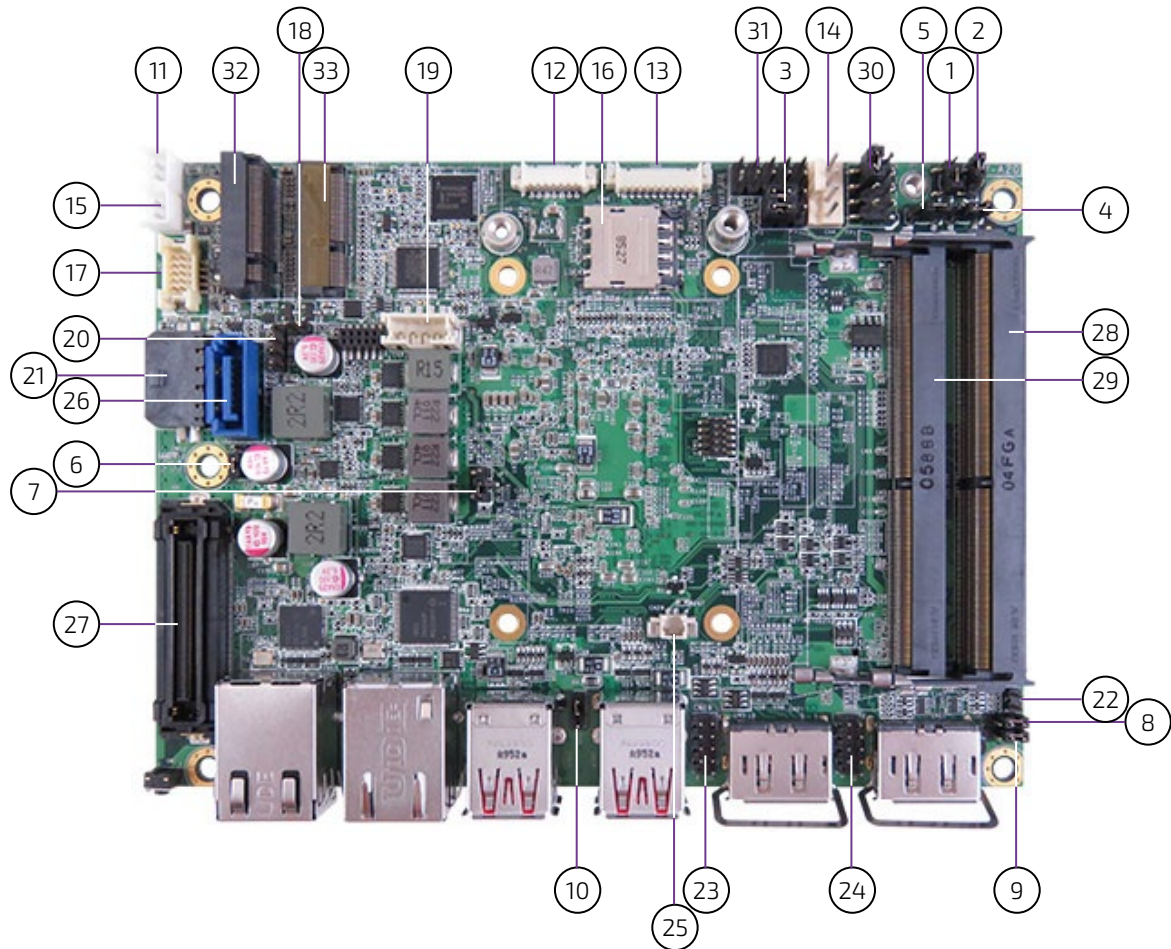

Table 8: Jumper List

Item	Designation	Description	See Chapter
1	JP1	LVDS Backlight Control Selection	7.19.1
2	JP2	M.2 Key B Selection	7.19.2
3	JP3	LVDS Panel Power Selection	7.19.3
4	JP4	LVDS Backlight Enable Selection	7.19.4
5	JP5	LVDS Backlight Enable Voltage Selection	7.19.5
6	JP6	Flash Descriptor Security Override Selection	7.19.6
7	JP7	AT / ATX Power Mode Selection	7.19.7
8	JP8	Clear CMOS Selection	7.19.8
9	JP9	MFG Mode Selection	7.19.9
10	JP10	USB Power Selection	7.19.10

Table 9: Top Side Internal Connector Pin Assignment

Item	Designation	Description	See Chapter
11	CN1	Left Channel Audio AMP Output Wafer	7.6
12	CN2	LVDS Backlight Power Wafer	7.11
13	CN3	DIO Header	7.12
14	CN4	Fan Wafer	7.2
15	CN5	Right Channel Audio AMP Output Wafer	7.6
16	CN6	Micro SIM Card Holder for M2B1	7.16
17	CN7	Audio Input / Output Header	7.7
18	CN8	Activity Indicator Header for M2B1	7.17
19	CN9	SATA Power Output Wafer	7.4
20	CN11	Activity Indicator Header for M2E1	7.17
21	CN12	+12 V DC Power Input Wafer	7.1.1
22	CN14	Activity Indicator Header for M2M1	7.17
23	CN19	USB 2.0 Port 5, 6 Header	7.5
24	CN20	USB 2.0 Port 7, 8 Header	7.5
25	CN26	RTC Power Input Wafer	7.1.2
26	CN27	SATA Port 0 Connector	7.3
27	CN28	Extended B2B Connector	7.18
28	DIMM1	DDR4 Channel 0 SO-DIMM Slot	3.6
29	DIMM2	DDR4 Channel 1 SO-DIMM Slot	3.6
30	FP1	Front Panel Header 1	7.8
31	FP2	Front Panel Header 2	7.8
32	M2B1	M.2 Key B 2242 / 3042 / 2280 Slot	7.13
33	M2E1	M.2 Key E 2230 Slot	7.14

4.2. Rear Side

Figure 3: Rear Side

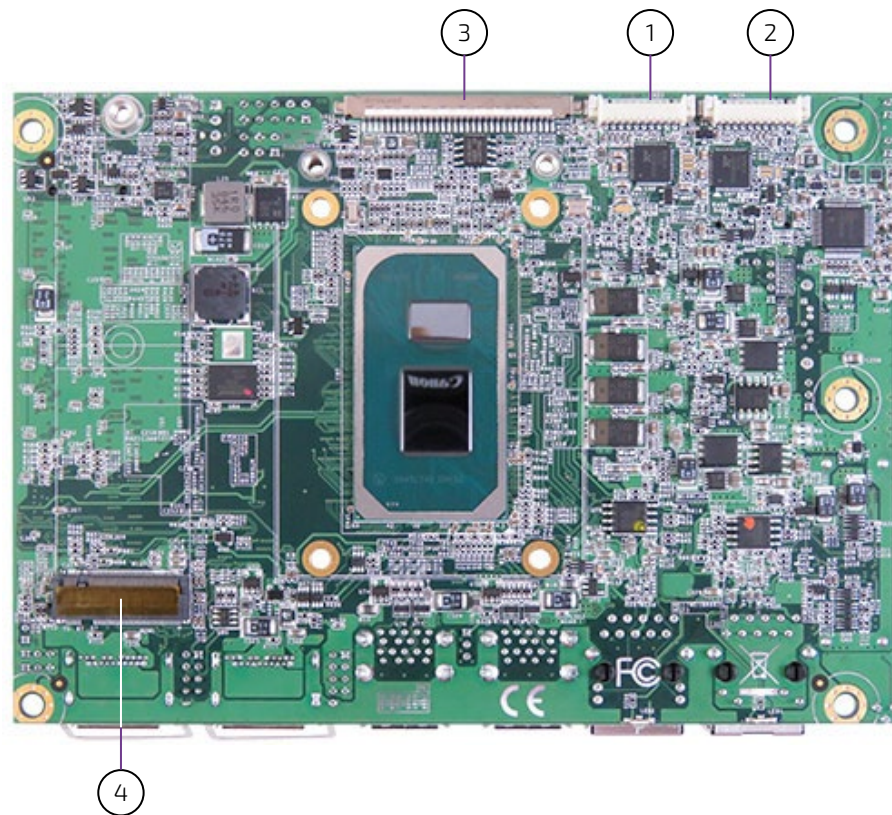

Table 10: Rear Side Internal Connector Pin Assignment

Item	Designation	Description	See Chapter
1	CN23	RS232/422/485 COM2 Wafer	7.9
2	CN24	RS232/422/485 COM1 Wafer	7.9
3	CN25	24-bit / 2-ch LVDS Connector	7.10
4	M2M1	M.2 Key M 2280 Slot	7.15

4.3. Connector Panel Side

Figure 4: Connector Panel Side

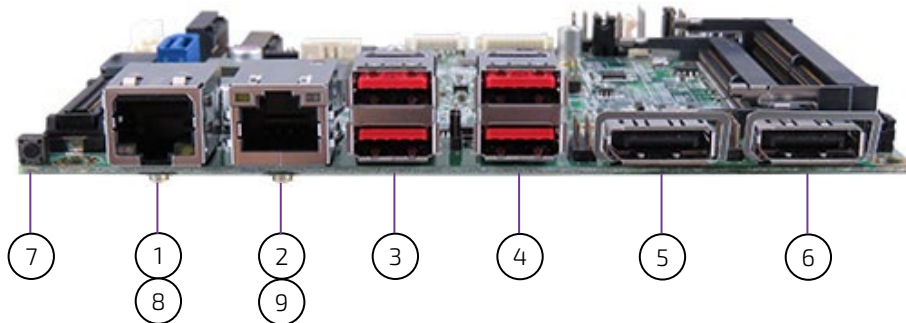

Table 11: Connector Panel Side Connector List

Item	Designation	Description	See Chapter
1	CN15	2.5GbE LAN1 RJ45 Connector	6.2
2	CN16	GbE LAN2 RJ45 Connector	6.2
3	CN17	USB 3.2 Gen 2 Port 3, 4 Type A Connector	6.3
4	CN18	USB 3.2 Gen 2 Port 1, 2 Type A Connector	6.3
5	CN21	DP Port 1 Connector	6.1
6	CN22	DP Port 2 Connector	6.1
7	SW1	Power Button	6.4
8	LED1	Power LED	6.5
9	LED2	Standby LED	6.5

5/ Connector Definitions

The following defined terms are used within this user guide to give more information concerning the pin assignment and to describe the connector's signals.

Defined Term	Description
Pin	Shows the pin numbers in the connector
Signal	The abbreviated name of the signal at the current pin The notation "XX#" states that the signal "XX" is active low
Note	Special remarks concerning the signal
Designation	Type and number of item described
See Chapter	Number of the chapter within this user guide containing a detailed description

The abbreviation TBD is used for specifications that are not available yet or which are not sufficiently specified by the component vendors.

6/ I/O-Area Connectors

6.1. DP Connector (CN21 & CN22)

The DP (DisplayPort) connectors are based on standard DP female port.

Figure 5: DP Connector CN21, CN22

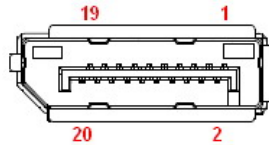

Table 12: Pin Assignment DP Connector CN21, CN22

Pin	Signal	Description	Note
1	ML_Lane0p	DisplayPort Lane 0 transmitter differential pair (+)	
2	GND	Ground	
3	ML_Lane0n	DisplayPort Lane 0 transmitter differential pair (-)	
4	ML_Lane1p	DisplayPort Lane 1 transmitter differential pair (+)	
5	GND	Ground	
6	ML_Lane1n	DisplayPort Lane 1 transmitter differential pair (-)	
7	ML_Lane2p	DisplayPort Lane 2 transmitter differential pair (+)	
8	GND	Ground	
9	ML_Lane2n	DisplayPort Lane 2 transmitter differential pair (-)	
10	ML_Lane3p	DisplayPort Lane 3 transmitter differential pair (+)	
11	GND	Ground	
12	ML_Lane3n	DisplayPort Lane 3 transmitter differential pair (-)	
13	Config1	Connected to ground, either directly or through a pulldown device	
14	Config2	Connected to ground, either directly or through a pulldown device	
15	AUX_CHp	DisplayPort Auxiliary channel differential pair (+)	
16	GND	Ground	
17	AUX_CHn	DisplayPort Auxiliary channel differential pair (-)	
18	Hot_Plug	DisplayPort hot plug detect	
19	GND	Ground	
20	DP_PWR	Power for connector	

6.2. Ethernet Connectors (CN15 & CN16)

The 3.5"-SBC-TGL supports one channel of 10/100/1000/2500 Mbit Ethernet and one channel of 10/100/1000 Mbit Ethernet, which are based Intel® I226-LM/IT and Intel® I210-AT/IT controller respectively.

In order to achieve the specified performance of the Ethernet port, Category 5 twisted pair cables must be used with 10/100 MByte and Category 5E, 6 or 6E with 1 Gbit/2.5Gbit LAN networks.

The signals for the Ethernet ports are as follows:

Figure 6: Ethernet Connector CN15

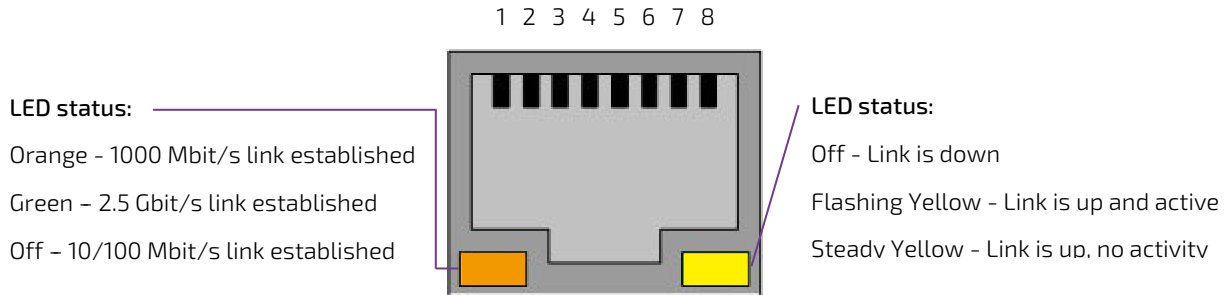

Figure 7: Ethernet Connector CN16

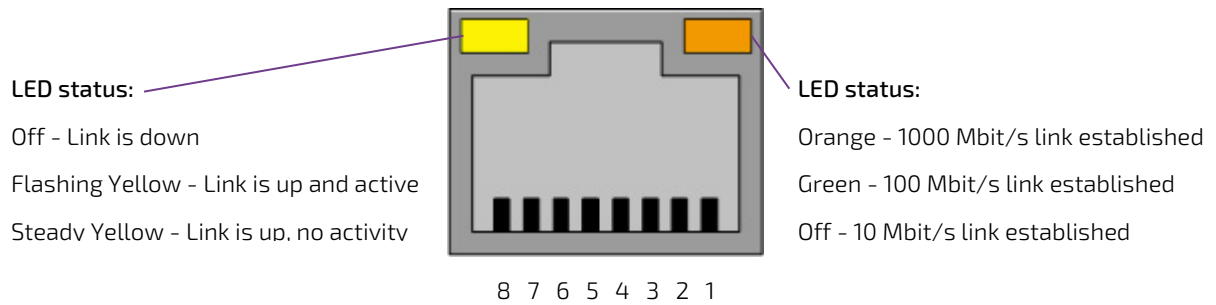

Table 13: Pin Assignment Ethernet Connectors CN15, CN16

Pin	Signal	Note
1	TX1+	
2	TX1-	
3	TX2+	
4	TX3+	
5	TX3-	
6	TX2-	
7	TX4+	
8	TX4-	

Signal Description

Signal	Description
--------	-------------

Signal	Description
TX1+ / TX1-	In MDI mode, this is the first pair in 2.5GBase-T and 1000Base-T, i.e. the BI_DA+/- pair, and is the transmit pair in 10Base-T and 100Base-TX. In MDI crossover mode, this pair acts as the BI_DB+/- pair, and is the receive pair in 10Base-T and 100Base-TX.
TX2+ / TX2-	In MDI mode, this is the second pair in 2.5GBase-T and 1000Base-T, i.e. the BI_DB+/- pair, and is the receive pair in 10Base-T and 100Base-TX. In MDI crossover mode, this pair acts as the BI_DA+/- pair, and is the transmit pair in 10Base-T and 100Base-TX.
TX3+ / TX3-	In MDI mode, this is the third pair in 2.5GBase-T and 1000Base-T, i.e. the BI_DC+/- pair. In MDI crossover mode, this pair acts as the BI_DD+/- pair.
TX4+ / TX4-	In MDI mode, this is the fourth pair in 2.5GBase-T and 1000Base-T, i.e. the BI_DD+/- pair. In MDI crossover mode, this pair acts as the BI_DC+/- pair.

'MDI' – media dependent Interface

6.3. USB Connectors (I/O Area)

The external I/O connector panel supports two dual USB 3.2 Gen 2 connectors.



USB 3.2 Gen 2 ports are backward compatible with USB 2.0.

Figure 8: USB 3.2 Gen 2 Connectors CN17 - Top & Bottom, CN18 - Top & Bottom



Table 14: Pin Assignment USB 3.2 Gen 2 / USB 2.0 Connectors CN17 - Top & Bottom, CN18 - Top & Bottom

Pin	Signal	Description	Note
1	+USB_VCC*	+5 V power supply for USB device	
2	USB_D-	USB 2.0 differential pair (-)	
3	USB_D+	USB 2.0 differential pair (+)	
4	GND	Ground	
5	USB_RX-	USB 3.2 receiver differential pair (-)	
6	USB_RX+	USB 3.2 receiver differential pair (+)	
7	GND	Ground	
8	USB_TX-	USB 3.2 transmitter differential pair (-)	
9	USB_TX+	USB 3.2 transmitter differential pair (+)	



* The power source of +USB_VCC can be selected by JP10.

For HiSpeed rates it is required to use a USB cable, which is specified in USB 2.0 standard:

Figure 9: USB 2.0 High Speed Cable

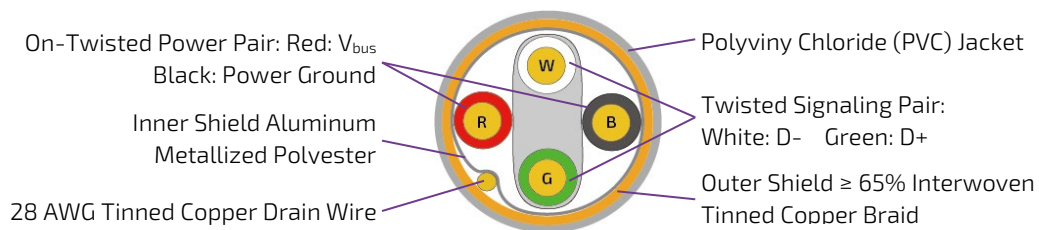

For USB 3.2 Gen 2 cabling it is required to use only HiSpeed USB cable, specified in USB 3.2 standard:

Figure 10: USB 3.2 High Speed Cable

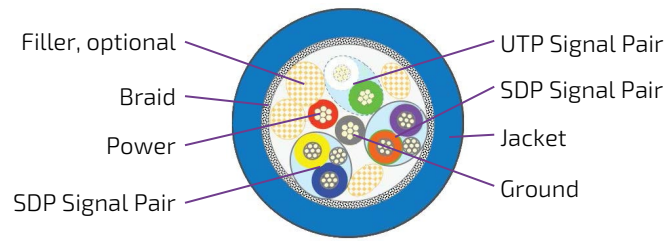

6.4. Power Button (SW1)

The external I/O connector panel supports a power button for turning on and off the board.

6.5. LED Indicators (LED1 & LED2)

The external I/O connector panel supports one power LED indicator and one standby LED indicator for power and standby status indication.

Table 15: LED Indicators LED1, LED2

LED Status		Description
Power LED (LED1)	Standby LED (LED2)	
Green LED On	Yellow LED On	S0 (Full On)
Green LED Blink	Yellow LED On	S3 (Suspend-To-RAM)
LED Off	Yellow LED On	S4 (Suspend-To-Disk) or S5 (Soft Off)
LED Off	LED Off	EUP Mode or G3 (Mechanical Off)

7/ Internal Connectors

7.1. Power Connector

Power connector must be used to supply the board with +12 VDC ($\pm 5\%$).

NOTICE

Hot plugging any of the power connector is not allowed.

Hot plugging might damage the board. In other words, turn off main supply etc. to make sure all the power lines are turned off when connecting to the motherboard.

7.1.1. Power Input Wafer (CN12)

The 1x4-pin 3.0 mm pitch power input wafer provides +12 V DC to the board.

Figure 11: Power Input Wafer CN12

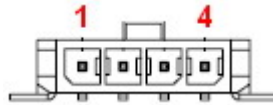

Table 16: Pin Assignment CN12

Pin	Signal	Description	Note
1	+12Vin	Power +12 V	
2	GND	Ground	
3	GND	Ground	
4	+12Vin	Power +12 V	
Connector Type			
B2W, 1x4-pin, 3.0 mm pitch			
Mating Connector			
Vendor	Pinrex		
Housing Model No.	733-75-M104B6		
Terminal Model No.	733-70-FT0006		

7.1.2. RTC Power Input Wafer (CN26)

The 1x2-pin 1.25 mm pitch RTC power input wafer is intended to be connected to the battery. The battery provides power to the system clock to retain the time when power is turn off.

Figure 12: RTC Power Input Wafer CN26



Table 17: Pin Assignment CN26

Pin	Signal	Description	Note
1	+VRTC	Real-time clock backup battery input	
2	GND	Ground	
Connector Type			
B2W, 1x2-pin, 1.25 mm pitch			
Mating Connector			
Vendor	Pinrex		
Housing Model No.	712-75-02W001		
Terminal Model No.	712-70-T00001		

7.2. Fan Wafer (CN4)

The 1x4-pin 2.54 mm pitch fan wafer (CN4) is used for the connection of the fan for the processor or system.

Figure 13: Fan Wafer CN4

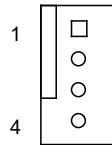

Table 18: Pin Assignment CN4

Pin	Signal	Description	Note
1	GND	Power supply ground signal	
2	+12V	+12 V power supply for fan	1 A max.
3	SENSE	Sense input signal from the fan, for rotation speed supervision RPM (Rotations Per Minute).	
4	PWM	PWM output signal for FAN speed control	
Connector Type			
B2W, 1x4-pin, 2.54 mm pitch			

7.3. SATA (Serial ATA) Port 0 Connector (CN27)

The SATA connector supplies the data connection for the SATA hard disk and is SATA 3.0 compatible.

Figure 14: SATA Port 0 Connector CN27

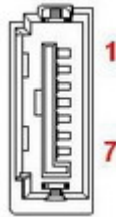

Table 19: Pin Assignment CN27

Pin	Signal	Description	Note
1	GND	Ground	
2	TX+	Host transmitter differential signal pair (+)	
3	TX-	Host transmitter differential signal pair (-)	
4	GND	Ground	
5	RX-	Host receiver differential signal pair (-)	
6	RX+	Host receiver differential signal pair (+)	
7	GND	Ground	
Connector Type			
B2W, 1x7-pin, 1.27 mm pitch			
Mating Connector			
Vendor	WINWIN		
Model No.	WATC-07DLPO2U		

7.4. SATA Power Output Wafer (CN9)

The 1x4-pin 2.0 mm pitch SATA power output wafer provides power to the SATA hard disk.

Figure 15: SATA Power Output Wafer CN9



Table 20: Pin Assignment CN9

Pin	Signal	Description	Note
1	+12V	+12 V power supply for HDD / SSD	1 A max.
2	GND	Ground	
3	GND	Ground	
4	+5V	+5 V power supply for HDD / SSD	1 A max.
Connector Type			
B2W, 1x4-pin, 2.0 mm pitch			
Mating Connector			
Vendor	Pinrex		
Housing Model No.	721-75-04W009		
Terminal Model No.	721-70-T00009		

7.5. USB Connectors (Internal) (CN19 & CN20)

The 10-pin 2.0 mm pitch USB port pin header CN19 & CN20 supports two USB 2.0 ports each.

Figure 16: USB 2.0 Port 5, 6 Pin Header CN19, Port 7, 8 Pin Header CN20

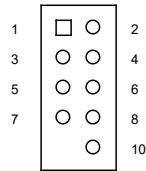

Table 21: Pin Assignment CN19, CN20

Pin	Signal	Description	Note
1	+USBVCC*	5 V supply. SB5V is supplied during power down to allow wakeup.	1 A max.
2	+USBVCC*	5 V supply. SB5V is supplied during power down to allow wakeup.	1 A max.
3	USB_DA-	USB 2.0 differential pair (-) for channel A	
4	USB_DB-	USB 2.0 differential pair (-) for channel B	
5	USB_DA+	USB 2.0 differential pair (+) for channel A	
6	USB_DB+	USB 2.0 differential pair (+) for channel B	
7	GND	Ground	
8	GND	Ground	
9	KEY		
10	GND	Ground	
Connector Type			
B2W, 2x5-pin, 2.0 mm pitch			
Mating Connector			
Vendor	Pinrex		
Housing Model No.	WL2004H-2*5P(DP2.0)		
Terminal Model No.	KB931-21T1A		



* The power source of +USBVCC for CN19 and CN20 can be selected by JP10.

7.6. Audio AMP Output Wafer (CN1 & CN5)

The Speaker audio-out interface is available through the 2-pin 2.0 mm pitch wafers CN1 for left channel and CN5 for right channel. These outputs are shared with the audio output (Line-out) signals of the audio pin header CN7.

Figure 17: Audio AMP Output Wafer CN1 (Left Channel), CN5 (Right Channel)

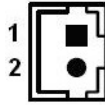

Table 22: Pin Assignment CN1, CN5

Pin	Signal	Description	Note
1	Speaker+	Speaker output (+)	
2	Speaker-	Speaker output (-)	
Connector Type			
B2W, 1x2-pin, 2.0 mm pitch			
Mating Connector			
Vendor	Pinrex		
Housing Model No.	721-75-02W009		
Terminal Model No.	721-70-T00009		

7.7. Audio Input / Output Header (CN7)

The audio input / output header provides audio output (Line-Out), audio input (Line-In) and microphone (Mic-In) signals through the 10-pin 1.25 mm pitch wafer CN7. The audio output signals are shared with those of the speaker connectors CN1 & CN5.

Figure 18: Audio Input / Output Header CN7

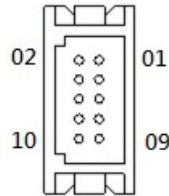

Table 23: Pin Assignment CN7

Pin	Signal	Description	Note
1	MIC-In_L	Microphone input left channel signal	
2	MIC-In_R	Microphone input right channel signal	
3	MIC-In_JD#	Microphone jack detection	
4	Line-In_JD#	Audio input jack detection	
5	Line-In_L	Audio input left channel signal	
6	Line-In_R	Audio input right channel signal	
7	Line-Out_L	Audio output left channel signal	
8	Line-Out_R	Audio output right channel signal	
9	Line-Out_JD#	Audio output jack detection	
10	GND	Ground	
Connector Type			
B2W, 2x5-pin, 1.25 mm pitch			
Mating Connector			
Vendor	HRS		
Housing Model No.	DF13-10DS-1.25C		
Terminal Model No.	WL1255-T-T-S		

7.8. Front Panel Header (FP1 & FP2)

The 8-pin 2.54 mm pitch front panel header FP1 supplies signals for the reset button, storage LED and system warning speaker.

The 10-pin 2.54 mm pitch front panel header FP2 supplies signals for the power button, power LED, and SM Bus.

Figure 19: Front Panel 1 Header FP1

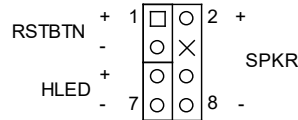

Table 24: Pin Assignment FP1

Pin	Signal	Description	Note
1	Reset Button +	System reset button (+)	
2	Speaker +	External system warning speaker (+)	
3	Reset Button -	System reset button (-)	
4	-	No connection	
5	HDD LED +	HDD activity LED (+). The LED lights up or flashes when data is ready from or written to the HDD.	
6	Internal Speaker -	Internal system warning speaker (-)	
7	HDD LED -	HDD activity LED (-).	
8	Speaker -	External system warning speaker (-)	
Connector Type			
B2W, 2x4-pin, 2.54 mm pitch			
Mating Connector			
Vendor	Pinrex		
Housing Model No.	741-75-204B01		
Terminal Model No.	741-70-FT0001		



Internal Buzzer is enabled when Pin6-8 is shorted.

Figure 20: Front Panel 2 Header FP2

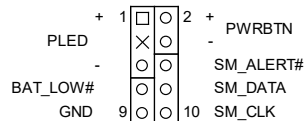

Table 25: Pin Assignment FP2

Pin	Signal	Description	Note
1	Power LED +	System Power LED (+). The LED lights up when users turn on the	

Pin	Signal	Description	Note
		system power, and blinks when the system is in sleep mode.	
2	Power Button +	System power button (+). Pressing the power button turns the system on or puts the system in sleep or soft-off mode depending on the operating system settings. Pressing the power switch for more than four seconds while the system turns from ON to OFF.	
3	-	No connection	
4	Power Button -	System power button (-).	
5	Power LED -	System Power LED (-).	
6	-	No connection	
7	-	No connection	
8	SMBus Data	System management bus bidirectional data line	
9	GND	Ground	
10	SMBus Clock	System management bus bidirectional clock line	
Connector Type			
B2W, 2x5-pin, 2.54 mm pitch			
Mating Connector			
Vendor	Pinrex		
Housing Model No.	741-75-205B01		
Terminal Model No.	741-70-FT0001		

7.9. Serial COM1 & COM2 Ports (CN24 & CN23)

The 10-pin 1.25 mm pitch serial COM wafer CN22 and CN23 provide RS232/422/485 connections.

Figure 21: Serial COM CN23, CN24

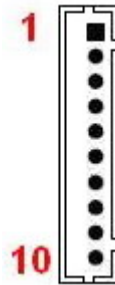

Table 26: Pin Assignment CN23, CN24

Pin	RS232 Signal	RS422 Signal	Half Duplex RS485 Signal	Full Duplex RS485 Signal	Note
1	DCD	TX-	DATA-	TX-	
2	DSR	-	-	-	
3	RXD	TX+	DATA+	TX+	
4	RTS	-	-	-	
5	TXD	RX+	-	RX+	
6	CTS	-	-	-	
7	DTR	RX-	-	RX-	
8	RI	-	-	-	
9	GND	GND	GND	GND	
10	+5V	+5V	+5V	+5V	500 mA max.
Connector Type					
B2W, 1x10-pin, 1.25 mm pitch					
Mating Connector					
Vendor	Pinrex				
Housing Model No.	712-75-10W001				
Terminal Model No.	712-70-T00001				

Table 27: Signal Description

Signal	Description
TXD	Transmitted Data, sends data to the communications link. The signal is set to the marking state (-12 V) on hardware reset when the transmitter is empty or when loop mode operation is initiated.
RXD	Received Data, receives data from the communications link.
DTR	Data Terminal Ready, indicates to the modem etc. that the on-board UART is ready to establish communication link.
DSR	Data Set Ready, indicates that the modem etc. is ready to establish a communications link.
RTS	Request To Send, indicates to the modem etc. that the on-board UART is ready to

Signal	Description
	exchange data.
CTS	Clear To Send, indicates that the modem or data set is ready to exchange data.
DCD	Data Carrier Detect, indicates that the modem or data set has detected the data carrier.
RI	Ring Indicator, indicates that the modem has received a ringing signal from the telephone line.
TX+/-	Transmitted Data differential pair sends data to the communications link.
RX+/-	Received Data differential pair receives data from the communications link.
GND	Power Supply GND signal

7.10. LVDS Connector (CN25)

The 30-pole 1.0 mm pitch JAE connector provides 24-bit, 2-channel LVDS panel connection.

Figure 22: LVDS Connector CN25

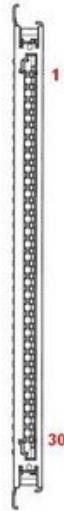

Table 28: Pin Assignment CN25

Pin	Signal	Description	Note
1	LVDSA_TX0-	LVDS Channel A Data 0 differential pair (-)	
2	LVDSA_TX0+	LVDS Channel A Data 0 differential pair (+)	
3	LVDSA_TX1-	LVDS Channel A Data 1 differential pair (-)	
4	LVDSA_TX1+	LVDS Channel A Data 1 differential pair (+)	
5	LVDSA_TX2-	LVDS Channel A Data 2 differential pair (-)	
6	LVDSA_TX2+	LVDS Channel A Data 2 differential pair (+)	
7	GND	Ground	
8	LVDSA_BCLK-	LVDS Channel A clock differential pair (-)	
9	LVDSA_BCLK+	LVDS Channel A clock differential pair (+)	
10	LVDSA_TX3-	LVDS Channel A Data 3 differential pair (-)	
11	LVDSA_TX3+	LVDS Channel A Data 3 differential pair (+)	
12	LVDSB_TX0-	LVDS Channel B Data 0 differential pair (-)	
13	LVDSB_TX0+	LVDS Channel B Data 0 differential pair (+)	
14	GND	Ground	
15	LVDSB_TX1-	LVDS Channel B Data 1 differential pair (-)	
16	LVDSB_TX1+	LVDS Channel B Data 1 differential pair (-)	
17	GND	Ground	
18	LVDSB_TX2-	LVDS Channel B Data 2 differential pair (-)	
19	LVDSB_TX2+	LVDS Channel B Data 2 differential pair (+)	
20	LVDSB_BCLK-	LVDS Channel B clock differential pair (-)	
21	LVDSB_BCLK+	LVDS Channel B clock differential pair (+)	

Pin	Signal	Description	Note
22	LVDSB_TX3-	LVDS Channel B Data 3 differential pair (-)	
23	LVDSB_TX3+	LVDS Channel B Data 3 differential pair (+)	
24	GND	Ground	
25	DDC_DATA	DDC channel Data	
26	VDDEN	Output Display Enable	
27	DDC_CLK	DDC Channel Clock	
28	+VPNL *	+3.3 V / +5 V panel power supply	500 mA max.
29	+VPNL *	+3.3 V / +5 V panel power supply	500 mA max.
30	+VPNL *	+3.3 V / +5 V panel power supply	500 mA max.
Connector Type			
B2W, 1x30-pin, 1.0 mm pitch			
Mating Connector			
Vendor	JAE		
Housing Model No.	WL1058HL-30P (FI-X30HL)		
Terminal Model No.	WL1058-G-P		



* Panel Power can be selected by JP3.

7.11. LVDS Backlight Power Wafer (CN2)

The 7-pin 1.25 mm pitch wafer CN2 provides power supply for flat panel and its backlight inverter.

Figure 23: LVDS Backlight Power Wafer CN2



Table 29: Pin Assignment CN2

Pin	Signal	Description	Note
1	BL_EN***	Backlight Enable signal	
2	GND	Ground	
3	+VBKLT**	+5 V / +12 V backlight power supply	750 mA max.
4	+VBKLT**	+5 V / +12 V backlight power supply	750 mA max.
5	GND	Ground	
6	BL_ADJ_VOL*	Backlight Adjustment Voltage signal	
7	BL_ADJ_PWM*	Backlight Adjustment PWM (Pulse Width Modulation) signal	
Connector Type			
B2W, 1x7-pin, 1.25 mm pitch			
Mating Connector			
Vendor	Pinrex		
Housing Model No.	WL1025H-7P (51021)		
Terminal Model No.	KB915-10T		



* BL_ADJ can be selected by JP1.



** Backlight Power can be selected by JP3.



*** BL_EN can be selected by JP4.

7.12. Digital Input / Output Header (CN3)

The 10-pin 1.25 mm pitch header CN3 supports 8-bit digital input / output signals to provide powering-on function of the connected devices.

Figure 24: Digital Input / Output Header CN3

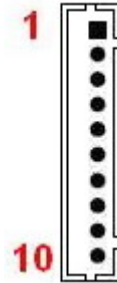

Table 30: Pin Assignment CN3

Pin	Signal	Description	Note
1	+5V	+5 V power supply	500 mA max.
2	DIO_0	Digital input / output channel 0	
3	DIO_1	Digital input / output channel 1	
4	DIO_2	Digital input / output channel 2	
5	DIO_3	Digital input / output channel 3	
6	DIO_4	Digital input / output channel 4	
7	DIO_5	Digital input / output channel 5	
8	DIO_6	Digital input / output channel 6	
9	DIO_7	Digital input / output channel 7	
10	GND	Ground	
Connector Type			
B2W, 1x10-pin, 1.25 mm pitch			
Mating Connector			
Vendor	Pinrex		
Housing Model No.	712-75-10W001		
Terminal Model No.	712-70-T00001		

7.13. M.2 Key B 2242 / 3042 / 2280 Slot (M2B1)

The 3.5"-SBC-TGL supports M.2 modules in format 2242 / 3042 / 2280 with Key B. The M.2 specification supports PCIe x1 / SATA 3.0 and USB 2.0 signals as well as UIM signals connected to Micro SIM card holder CN6. The slot can be used to integrate WWAN communication to the mainboard.

NOTICE

The module will protrude over the edge of the baseboard in case of installing a M.2 3042 module. Designers shall prescribe the chassis size with regard for maximum assembly dimensions.

Figure 25: M.2 Key B 3042 / 2280 Slot M2B1

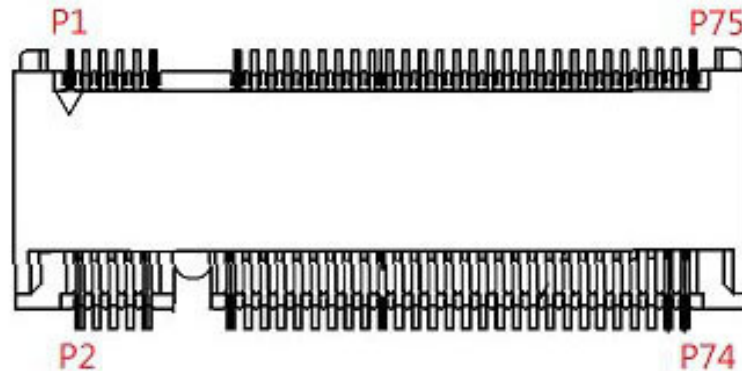

Table 31: Pin Assignment M2B1

Pin	Signal	Description	Note
1	-		
2	+3.3V	3.3 V power supply	
3	GND	Ground	
4	+3.3V	3.3 V power supply	
5	GND	Ground	
6	PWROFF#	M.2 module power enable	
7	USB_D+	USB 2.0 data differential pair (+)	
8	DISABLE#	Wireless disable	
9	USB_D-	USB 2.0 data differential pair (-)	
10	LED#	Device active signal	
11	GND	Ground	
12	KEY		
13	KEY		
14	KEY		
15	KEY		
16	KEY		
17	KEY		
18	KEY		
19	KEY		
20	-		

Pin	Signal	Description	Note
21	-		
22	-		
23	-		
24	-		
25	-		
26	-		
27	GND	Ground	
28	-		
29	-		
30	UIM_RESET*	SIM card reset	
31	-		
32	UIM_CLK*	SIM card clock	
33	GND	Ground	
34	UIM_DATA*	SIM card data	
35	-		
36	UIM_PWR*	SIM card power	
37	-		
38	-		
39	GND	Ground	
40	-		
41	PERn0 / SATA_B+	PCIe Lane 0 receiver pair (-) / SATA transmitter pair (+)	
42	-		
43	PERp0 / SATA_B-	PCIe Lane 0 receiver pair (+) / SATA transmitter pair (-)	
44	-		
45	GND	Ground	
46	-		
47	PETn0 / SATA_A-	PCIe Lane 0 transmitter pair (-) / SATA receiver pair (-)	
48	-		
49	PETp0 / SATA_A+	PCIe Lane 0 transmitter pair (+) / SATA receiver pair (+)	
50	PERST#	PCIe reset	
51	GND	Ground	
52	CLKREQ#	Reference clock request signal	
53	REFCLKn	PCIe reference clock pair (-)	
54	WAKE#	PCIe wake	
55	REFCLKp	PCIe reference clock pair (+)	
56	-		
57	GND	Ground	
58	-		
59	-		
60	-		
61	-		
62	-		

Pin	Signal	Description	Note
63	-		
64	-		
65	-		
66	SIM_DETECT	SIM card detect	
67	-		
68	SUSCLK	32.768 kHz clock supply input	
69	-		
70	+3.3V	3.3 V power supply	
71	GND	Ground	
72	+3.3V	3.3 V power supply	
73	GND	Ground	
74	+3.3V	3.3 V power supply	
75	-		



* These pins are connected to CN6 Micro SIM card holder directly.

7.14. M.2 Key E 2230 Slot (M2E1)

The 3.5"-SBC-TGL supports M.2 modules in format 2230 with Key E. The M.2 specification supports PCIe x1, USB 2.0, UART, PCM and / or CNVi signals. The slot can be used to integrate WLAN (Wi-Fi or CNVi Wi-Fi) and / or Bluetooth communication to the mainboard.

Figure 26: M.2 Key E 2230 Slot M2E1

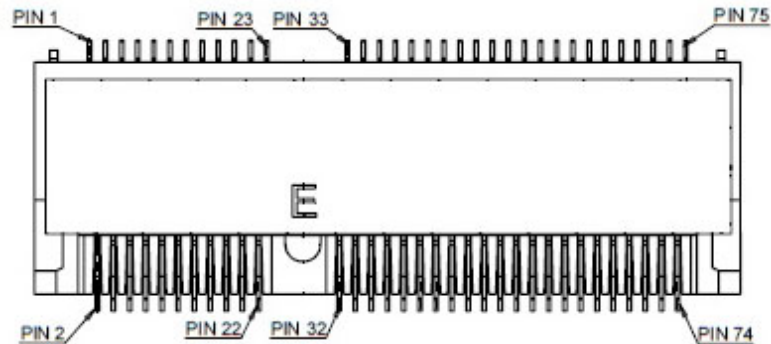

Table 32: Pin Assignment M2E1

Pin	Key E*		CNVi*		Note
	Signal	Description	Signal	Description	
1	GND	Ground	GND	Ground	
2	+3.3V	3.3 V power supply	+3.3V	3.3 V power supply	
3	USB_D+	USB 2.0 data diff. pair (+)	-		
4	+3.3V	3.3 V power supply	+3.3V	3.3 V power supply	
5	USB_D-	USB 2.0 data diff. pair (-)	-		
6	LED1#	Device active signal 1	LED1#	Device active signal 1	
7	GND	Ground	GND	Ground	
8	PCM_CLK	PCM synchronous data clock	-		
9	-		WGR_D1N	CNVio bus Rx Lane 1 (-)	
10	PCM_SYNC	PCM synchronous data sync	LCP_RSTN	RF companion (CRF) reset	
11	-		WGR_D1P	CNVio bus Rx Lane 1 (+)	
12	PCM_IN	PCM synchronous data input	-		
13	GND	Ground	GND	Ground	
14	PCM_OUT	PCM synchronous data output	CLKREQ0	Clock request	
15	-		WGR_D0N	CNVio bus Rx Lane 0 (-)	
16	LED2#	Device active signal 2	LED2#	Device active signal 2	
17	-		WGR_D0P	CNVio bus Rx Lane 0 (+)	
18	GND	Ground	GND	Ground	
19	GND	Ground	GND	Ground	
20	UART_WAKE#	UART wake-up	-		
21	-		WGR_CLKN	CNVio bus Rx clock (-)	
22	UART_RX	UART data input	BRI_RSP	BRI bus Rx	
23	-		WGR_CLKP	CNVio bus Rx clock (+)	

Pin	Key E*		CNVi*		Note
	Signal	Description	Signal	Description	
24	Key		Key		
25	Key		Key		
26	Key		Key		
27	Key		Key		
28	Key		Key		
29	Key		Key		
30	Key		Key		
31	Key		Key		
32	UART_TX	UART data output	RGI_DT	RGI bus Tx	
33	GND	Ground	GND	Ground	
34	UART_CTS	UART clear to send	RGI_RSP	RGI bus Rx	
35	PET0+	PCIe Lane 0 Tx pair (+)	-		
36	UART_RTS	UART request to send	BRI_DT	BRI bus Tx	
37	PET0-	PCIe Lane 0 Tx pair (-)	-		
38	Clink_RST	Wi-Fi CLINK host bus reset	-		
39	GND	Ground	GND	Ground	
40	Clink_DATA	Wi-Fi CLINK host bus data	-		
41	PER0+	PCIe Lane 0 Rx pair (+)	-		
42	Clink_CLK	Wi-Fi CLINK host bus clock	-		
43	PER0-	PCIe Lane 0 Rx pair (-)	-		
44	-		-		
45	GND	Ground	GND	Ground	
46	-		-		
47	REFCLK0+	PCIe reference clock pair (+)	-		
48	-		-		
49	REFCLK0-	PCIe reference clock pair (-)	-		
50	SUSCLK	32.768 kHz clock supply input	SUSCLK	32.768 kHz clock supply input	
51	GND	Ground	GND	Ground	
52	PERST0#	PCIe reset	-		
53	CLKREQ0#	Reference clock request signal	-		
54	W_DISABLE2#	Wireless disable 2	W_DISABLE2#	Wireless disable 2	
55	PEWAKE0#	PCIe wake	-		
56	W_DISABLE1#	Wireless disable 1	W_DISABLE1#	Wireless disable 1	
57	GND	Ground	GND	Ground	
58	-		-		
59	-		WT_D1N	CNVio bus Tx Lane 1 (-)	
60	-		-		
61	-		WT_D1P	CNVio bus Tx Lane 1 (+)	
62	-		-		
63	GND	Ground	GND	Ground	
64	-		REFCLK0	Reference clock	

Pin	Key E*		CNVi*		Note
	Signal	Description	Signal	Description	
65	-		WT_D0N	CNVio bus Tx Lane 0 (-)	
66	-		-		
67	-		WT_D0P	CNVio bus Tx Lane 0 (+)	
68	-		-		
69	GND	Ground	GND	Ground	
70	-		-		
71	-		WT_CLKN	CNVio bus Tx clock (-)	
72	+3.3V	3.3 V power supply	+3.3V	3.3 V power supply	
73	-		WT_CLKP	CNVio bus Tx clock (+)	
74	+3.3V	3.3 V power supply	+3.3V	3.3 V power supply	
75	GND	Ground	GND	Ground	



* The board will auto-detect the module type and re-configure itself to an appropriate mode.

7.15. M.2 Key M 2280 Slot (M2M1)

The 3.5"-SBC-TGL supports M.2 modules in format 2280 with Key M. The M.2 specification supports PCIe x4 signal. The slot can be used to integrate an M.2 PCIe x4 SSD (NVMe) to the mainboard.

Figure 27: M.2 Key M 2280 Slot M2M1

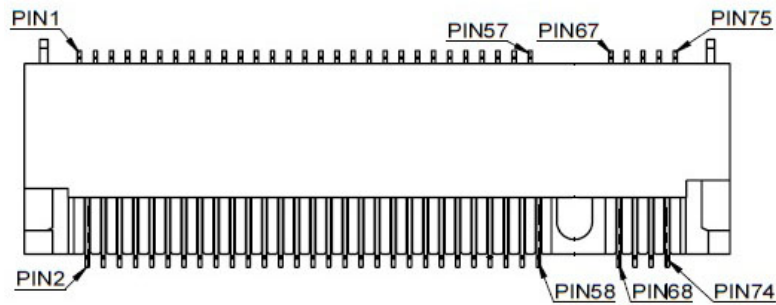

Table 33: Pin Assignment M2M1

Pin	Signal	Description	Note
1	GND	Ground	
2	+3.3V	3.3 V power supply	
3	GND	Ground	
4	+3.3V	3.3 V power supply	
5	PERn3	PCIe Lane 3 receiver pair (-)	
6	-		
7	PERp3	PCIe Lane 3 receiver pair (+)	
8	-	-	
9	GND	Ground	
10	DAS / DSS# / LED1#	Device active signal / disable staggered spin-up / LED	
11	PETn3	PCIe Lane 3 transmitter pair (-)	
12	+3.3V	3.3 V power supply	
13	PETp3	PCIe Lane 3 transmitter pair (+)	
14	+3.3V	3.3 V power supply	
15	GND	Ground	
16	+3.3V	3.3 V power supply	
17	PERn2	PCIe Lane 2 receiver pair (-)	
18	+3.3V	3.3 V power supply	
19	PERp2	PCIe Lane 2 receiver pair (-)	
20	-		
21	GND	Ground	
22	-		
23	PETn2	PCIe Lane 2 transmitter pair (-)	
24	-		
25	PETp2	PCIe Lane 2 transmitter pair (+)	
26	-		

Pin	Signal	Description	Note
27	GND	Ground	
28	-		
29	PERn1	PCIe Lane 1 receiver pair (-)	
30	-		
31	PERp1	PCIe Lane 1 receiver pair (+)	
32	-		
33	GND	Ground	
34	-		
35	PETn1	PCIe Lane 1 transmitter pair (-)	
36	-		
37	PETp1	PCIe Lane 1 transmitter pair (+)	
38	DEVSLP	Device sleep	
39	GND	Ground	
40	-		
41	PERn0	PCIe Lane 0 receiver pair (-)	
42	-		
43	PERp0	PCIe Lane 0 receiver pair (+)	
44	-		
45	GND	Ground	
46	-		
47	PETn0	PCIe Lane 0 transmitter pair (-)	
48	-		
49	PETp0	PCIe Lane 0 transmitter pair (+)	
50	PERST#	PCIe reset	
51	GND	Ground	
52	CLKREQ#	Reference clock request signal	
53	REFCLKn	PCIe reference clock pair (-)	
54	PEWAKE#	PCIe wake	
55	REFCLKp	PCIe reference clock pair (+)	
56	-		
57	GND	Ground	
58	-		
59	Key		
60	Key		
61	Key		
62	Key		
63	Key		
64	Key		
65	Key		
66	Key		
67	-		
68	SUSCLK	32.768 kHz clock supply input	

Pin	Signal	Description	Note
69	PEDET	PCIe detect	
70	+3.3V	3.3 V power supply	
71	GND	Ground	
72	+3.3V	3.3 V power supply	
73	GND	Ground	
74	+3.3V	3.3 V power supply	
75	GND	Ground	

7.16. Micro SIM Card Holder for M.2 Key B (CN6)

The Micro SIM card holder CN6 is intended to accommodate a Micro SIM card and connected to UIM signals on the M.2 Key B slot M2B1.

Figure 28: Micro SIM Card Holder CN6

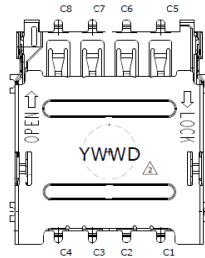

Table 34: Pin Assignment CN6

Pin	Signal	Description	Note
C1	VCC	Power +3.3 V	
C2	RST	Reset signal	
C3	CLK	Clock signal	
C4	NC	Not connected	
C5	GND	Ground	
C6	VPP	Programming voltage input	
C7	IO	Input or Output for serial data	
C8	NC	Not connected	

7.17. M.2 Key B / M.2 Key E / M.2 Key M Activity Indicator Header (CN8, CN11 & CN14)

The header CN8 is intended to connect M.2 Key B activity LED cable.

The header CN11 is intended to connect M.2 Key E activity LED cable.

The header CN14 is intended to connect M.2 Key M activity LED cable.

Figure 29: M.2 Key B / M.2 Key M Activity Indicator Header CN8, CN14

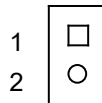

Table 35: Pin Assignment CN8, CN14

Pin	Signal	Description	Note
1	LED+	M.2 Key B / M.2 Key M activity LED (+)	
2	LED-	M.2 Key B / M.2 Key M activity LED (-)	
Connector Type			
B2W, 1x2-pin, 2.0 mm pitch			

Figure 30: M.2 Key E Activity Indicator Header CN11

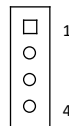

Table 36: Pin Assignment CN11

Pin	Signal	Description	Note
1	WLAN_LED1+	WLAN LED (+)	
2	WLAN_LED1-	WLAN LED (-)	
3	BR_LED2+	Breath LED (+)	
4	BR_LED2-	Breath LED (-)	
Connector Type			
B2W, 1x4-pin, 2.0 mm pitch			

7.18. Extended B2B Connector (CN28)

The extended board-to-board connector provides connection to a daughter board for additional I/O port and / or feature expansion. The specification of the B2B connector supports DDI (eDP / DP), PCIe x2, PCIe x1, SM bus, I2C, UART and GSPI signals.

Figure 31: Extended B2B Connector CN28

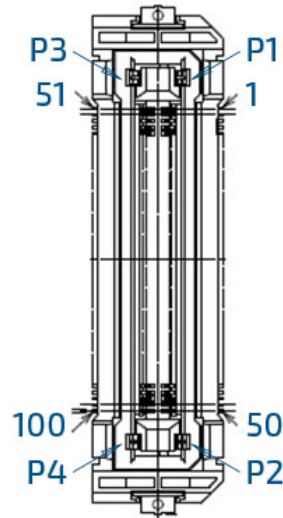

Table 37: Pin Assignment CN28

Pin	Signal	Description	Note
1	+3.3VSB_OUT	3.3 V standby power output	400 mA max.
2	+3.3VSB_OUT	3.3 V standby power output	400 mA max.
3	+3.3VSB_OUT	3.3 V standby power output	400 mA max.
4	+3.3VSB_OUT	3.3 V standby power output	400 mA max.
5	+3.3VSB_OUT	3.3 V standby power output	400 mA max.
6	GND	Ground	
7	eDP_DP0_TX0+	eDP / DP 0 Lane 0 transmitter pair (+)	
8	eDP_DP0_TX0-	eDP / DP 0 Lane 0 transmitter pair (-)	
9	GND	Ground	
10	eDP_DP0_TX1+	eDP / DP 0 Lane 1 transmitter pair (+)	
11	eDP_DP0_TX1-	eDP / DP 0 Lane 1 transmitter pair (-)	
12	GND	Ground	
13	eDP_DP0_TX2+	eDP / DP 0 Lane 2 transmitter pair (+)	
14	eDP_DP0_TX2-	eDP / DP 0 Lane 2 transmitter pair (-)	
15	GND	Ground	
16	eDP_DP0_TX3+	eDP / DP 0 Lane 3 transmitter pair (+)	
17	eDP_DP0_TX3-	eDP / DP 0 Lane 3 transmitter pair (-)	
18	GND	Ground	
19	eDP_DP0_AUX+	eDP / DP 0 Auxiliary channel pair (+)	
20	eDP_DP0_AUX-	eDP / DP 0 Auxiliary channel pair (-)	

Pin	Signal	Description	Note
21	GND	Ground	
22	PCIE0_CLK_REF+	PCIe Lane 0 clock reference pair (+)	
23	PCIE0_CLK_REF-	PCIe Lane 0 clock reference pair (-)	
24	GND	Ground	
25	PCIE0_TX+	PCIe Lane 0 transmitter pair (+)	
26	PCIE0_TX-	PCIe Lane 0 transmitter pair (-)	
27	GND	Ground	
28	PCIE0_RX+	PCIe Lane 0 receiver pair (+)	
29	PCIE0_RX-	PCIe Lane 0 receiver pair (-)	
30	GND	Ground	
31	PCIE2_TX+	PCIe Lane 2 receiver pair (+)	
32	PCIE2_TX-	PCIe Lane 2 receiver pair (-)	
33	GND	Ground	
34	PCIE2_RX+	PCIe Lane 2 receiver pair (+)	
35	PCIE2_RX-	PCIe Lane 2 receiver pair (-)	
36	GND	Ground	
37	NC	Not connected	
38	NC	Not connected	
39	GND	Ground	
40	UART_TXD	UART transmitted data	
41	UART_RXD	UART received data	
42	UART_CTS#	UART clear to send	
43	UART_RTS#	UART request to send	
44	GND	Ground	
45	eDP_PWM	eDP backlight PWM (Pulse Width Modulation) signal	
46	eDP_VDDEN	eDP panel power enable signal	
47	eDP_BKLTEN	eDP backlight enable signal	
48	eDP_D00_HPD	eDP / DP 0 hot plug detect	
49	eDP_DPO_EN#	eDP / DP 0 enable	
50	NC	Not connected	
51	GSPI_CLK	General SPI clock	
52	GSPI_MOSI	General SPI master output / slave input	
53	GSPI_MISO	General SPI master input / slave output	
54	GSPI_CS0#	General SPI chip select bit 0	
55	GSPI_CS1#	General SPI chip select bit 1	
56	GND	Ground	
57	DP1_TX0+	DP 1 Lane 0 transmitter pair (+)	
58	DP1_TX0-	DP 1 Lane 0 transmitter pair (-)	
59	GND	Ground	
60	DP1_TX1+	DP 1 Lane 1 transmitter pair (+)	
61	DP1_TX1-	DP 1 Lane 1 transmitter pair (-)	
62	GND	Ground	

Pin	Signal	Description	Note
63	DP1_TX2+	DP 1 Lane 2 transmitter pair (+)	
64	DP1_TX2-	DP 1 Lane 2 transmitter pair (-)	
65	GND	Ground	
66	DP1_TX3+	DP 1 Lane 3 transmitter pair (+)	
67	DP1_TX3-	DP 1 Lane 3 transmitter pair (-)	
68	GND	Ground	
69	DP1_AUX+	DP 1 Auxiliary channel pair (+)	
70	DP1_AUX-	DP 1 Auxiliary channel pair (-)	
71	GND	Ground	
72	PCIE1_CLK_REF+	PCIe Lane 1 clock reference pair (+)	
73	PCIE1_CLK_REF-	PCIe Lane 1 clock reference pair (-)	
74	GND	Ground	
75	PCIE1_TX+	PCIe Lane 1 transmitter pair (+)	
76	PCIE1_TX-	PCIe Lane 1 transmitter pair (-)	
77	GND	Ground	
78	PCIE1_RX+	PCIe Lane 1 receiver pair (+)	
79	PCIE1_RX-	PCIe Lane 1 receiver pair (-)	
80	GND	Ground	
81	NC	Not connected	
82	NC	Not connected	
83	GND	Ground	
84	NC	Not connected	
85	NC	Not connected	
86	GND	Ground	
87	NC	Not connected	
88	NC	Not connected	
89	GND	Ground	
90	I2C_CLK	I2C clock	
91	I2C_DATA	I2C data	
92	SMB_CLK	SM bus clock	
93	SMB_DATA	SM bus data	
94	GND	Ground	
95	SMB_ALERT#	SM bus alert	
96	PCIE_WAKE#	PCIe wake	
97	PCIE_PLTRST#	PCIe platform reset	
98	DP1_HPD	DP 1 hot plug detect	
99	DP1_EN#	DP 1 enable	
100	PS_ON#	Power supply enable / disable	
P1	+5VSB_OUT	5 V standby power output	2 A max.
P2	+12V_IN / +12V_OUT	12 V power input / 12 V power output	3 A max.
P3	+12V_IN / +12V_OUT	12 V power input / 12 V power output	3 A max.
P4	+12V_IN / +12V_OUT	12 V power input / 12 V power output	3 A max.

Pin	Signal	Description	Note
Connector Type			
B2B, 2x50-pin, 0.5 mm pitch			
Mating Connector			
Vendor	HRS		
Model No.	FX23-100P-0.5SV20		

7.19. Switches and Jumpers

The product has several jumpers which must be properly configured to ensure correct operation.

Figure 32: Jumper Connector

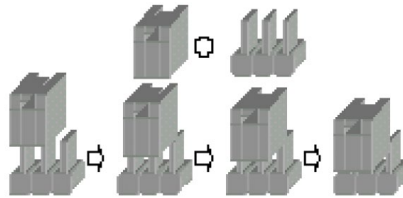

For a three-pin jumper (see Figure 32), the jumper setting is designated "1-2" when the jumper connects pins 1 and 2. The jumper setting is designated "2-3" when pins 2 and 3 are connected and so on. You will see that one of the lines surrounding a jumper pin is thick, which indicates pin No.1.

To move a jumper from one position to another, use needle-nose pliers or tweezers to pull the pin cap off the pins and move it to the desired position.

7.19.1. LVDS Backlight Control Selection (JP1)

The 2.0 mm pitch "LVDS Backlight Control Selection" jumper (JP1) can be used to select by which mode the brightness level in the LCD panel is controlled.

Figure 33: LVDS Backlight Control Selection JP1

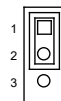

Table 38: Pin Assignment JP1

Jumper 1 Position		Description
Pin 1-2	Pin 2-3	
X	-	PWM Control Mode
-	X	Voltage Control Mode

"X" = Jumper set (short) and "-" = jumper not set (open)

7.19.2. M.2 Key B Selection (JP2)

The 2.0 mm pitch "M.2 Key B Selection" jumper (JP2) can be used to select which interface of M.2 SSD the M.2 Key B slot supports.

Figure 34: M.2 Key B Selection JP2



Table 39: Pin Assignment JP2

Jumper 1 Position		Description
Pin 1-2	Pin 2-3	
X	-	PCIe x1
-	X	SATA (Default)

"X" = Jumper set (short) and "-" = jumper not set (open)

7.19.3. LVDS Panel Power Selection (JP3)

The 2.54 mm pitch "LVDS Panel Power Selection" jumper (JP3) can be used to select LVDS panel and backlight power voltage.

Figure 35: LVDS Panel Power Selection JP3

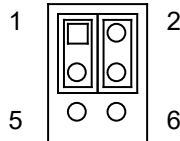

Table 40: Pin Assignment JP3

Jumper 1 Position		Description
Pin 1-3	Pin 3-5	
X	-	Backlight Power = +12 V
-	X	Backlight Power = +5 V
Jumper 2 Position		Description
Pin 2-4	Pin 4-6	
X	-	Panel Power = +3.3 V
-	X	Panel Power = +5 V

"X" = Jumper set (short) and "-" = jumper not set (open)

7.19.4. LVDS Backlight Enable Selection (JP4)

The 2.0 mm patch "LVDS Backlight Enable Selection" jumper (JP4) can be used to select the polarity of backlight enable signal.

Figure 36: LVDS Backlight Enable Selection JP4



Table 41: Pin Assignment JP4

Jumper 1 Position		Description
Pin 1-2	Pin 2-3	
X	-	High Active
-	X	Low Active

"X" = Jumper set (short) and "-" = jumper not set (open)

7.19.5. LVDS Backlight Enable Voltage Selection (JP5)

The 2.0 mm patch "LVDS Backlight Enable Voltage Selection" jumper (JP5) can be used to select voltage level of backlight enable signal.

Figure 37: LVDS Backlight Enable Voltage Selection JP5

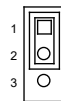

Table 42: Pin Assignment JP5

Jumper 1 Position		Description
Pin 1-2	Pin 2-3	
X	-	+3.3 V
-	X	+5 V

"X" = Jumper set (short) and "-" = jumper not set (open)

7.19.6. Flash Descriptor Security Override Selection (JP6)

The 2.0 mm pitch "Flash Descriptor Security Override Selection" jumper (JP6) can be used to specify whether to override the flash descriptor.

Figure 38: Flash Descriptor Security Override Selection JP6

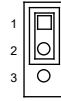

Table 43: Pin Assignment JP6

Jumper 1 Position		Description
Pin 1-2	Pin 2-3	
X	-	Normal Operation
-	X	Flash Security Override

"X" = Jumper set (short) and "-" = jumper not set (open)

7.19.7. AT / ATX Power Mode Selection (JP7)

The 2.0 mm pitch jumper JP7 can be used to select AT power mode or ATX power mode.

Figure 39: AT / ATX Power Mode Selection JP7

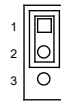

Table 44: Pin Assignment JP7

Jumper 1 Position		Description
Pin 1-2	Pin 2-3	
X	-	ATX Power Mode
-	X	AT Power Mode

"X" = Jumper set (short) and "-" = jumper not set (open)

7.19.8. Clear CMOS Selection (JP8)

The 2.0 mm pitch "Clear COMS Selection" jumper (JP8) can be used to reset the Real Time Clock (RTC) and drain RTC well.

The jumper has one position: Pin 1-2 mounted (default position) and Pin 2-3 mounted. More information on setting the "Clear CMOS Selection" jumper can be found in the following table.

Figure 40: Clear CMOS Selection JP8

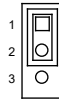

Table 45: Pin Assignment JP8

Jumper 1 Position		Description
Pin 1-2	Pin 2-3	
X	-	Normal Operation (default position)
-	X	Clear CMOS (board does not boot with the jumper in this position)

"X" = Jumper set (short) and "-" = jumper not set (open)



Do not leave the jumper in position 2-3, otherwise if the power is disconnected, the battery will fully deplete within a few weeks.

7.19.9. MFG Mode Selection (JP9)

The 2.0 mm pitch "MFG Mode Selection" jumper (JP9) can be used to rewrite Intel ME firmware onto another version.

Figure 41: MFG Mode Selection JP9

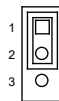

Table 46: Pin Assignment JP9

Jumper 1 Position		Description
Pin 1-2	Pin 2-3	
X	-	Normal Operation
-	X	Enable MFG Mode

"X" = Jumper set (short) and "-" = jumper not set (open)

7.19.10. USB Power Selection (JP10)

The 2.0 mm pitch "USB Power Selection" jumper (JP10) can be used to determine whether the USB ports are powered in the S4 / S5 state.

Figure 42: USB Power Selection JP10



Table 47: Pin Assignment JP10

Jumper 1 Position		Description
Pin 1-2	Pin 2-3	
X	-	+5 V
-	X	+5 VSB

"X" = Jumper set (short) and "-" = jumper not set (open)

8/ BIOS

8.1. Starting the uEFI BIOS

The 3.5"-SBC-TGL is provided with a Kontron-customized, pre-installed and configured version of AMI Aptio® V uEFI BIOS. AMI BIOS firmware is based on the Unified Extensible Firmware Interface (UEFI) specification and the Intel® Platform Innovation Framework for EFI. This uEFI BIOS provides a variety of new and enhanced functions specifically tailored to the hardware features of the 3.5"-SBC-TGL.

The uEFI BIOS comes with a setup program that provides quick and easy access to the individual function settings for control or modification of the uEFI BIOS configuration. The setup program allows the accessing of various menus that provide functions or access to sub-menus with more specific functions of their own.

To start the uEFI BIOS setup program, follow the steps below:

1. Power on the board.
2. Wait until the first characters appear on the screen (POST messages or splash screen).
3. Press the key.
4. If the uEFI BIOS is password-protected, a request for password will appear. Enter either the User Password or the Supervisor Password (see Security menu), press <RETURN>, and proceed with step 5.
5. A setup menu will appear.

The 3.5"-SBC-TGL uEFI BIOS setup program uses a hot key-based navigation system. A hot key legend bar is located on the bottom of the setup screens.

The following table provides information concerning the usage of these hot keys.

Table 48: Hotkeys Table

Signal	Description
<F1>	The <F1> key invokes the General Help window.
<->	The <Minus> key selects the next lower value within a field.
<+>	The <Plus> key selects the next higher value within a field.
<F2>	The <F2> key loads the previous values.
<F3>	The <F3> key loads the standard default values.
<F4>	The <F4> key saves the current settings and exit the uEFI BIOS setup.
<→> or <←>	The <Left/Right> arrows selects major setup menus on the menu bar. For example: Main, Advanced, Security, etc.
<↑> or <↓>	The <Up/Down> arrows selects fields in the current menu. For example: A setup function or a sub-screen.
<ESC>	The <ESC> key exits a major setup menu and enter the Exit setup menu. Pressing the <ESC> key in a sub-menu displays the next higher menu level.
<RERURN>	The <RETURN> key executes a command or select a submenu.

8.2. Starting the uEFI BIOS

The Setup utility features shows six menus in the selection bar at the top of the screen:

- ▶ Main
- ▶ Advanced
- ▶ Power
- ▶ Boot
- ▶ Security
- ▶ Save & Exit

The Setup menus are selected via the left and right arrow keys. The currently active menu and the currently active uEFI BIOS Setup item are highlighted in white. Each Setup menu provides two main frames. The left frame displays all available functions. Functions that can be configured are displayed in blue. Functions displayed in gray provide information about the status or the operational configuration. The right frame displays an Item Specific Help window providing an explanation of the respective function.

8.2.1. Main Setup Menu

Upon entering the uEFI BIOS Setup program, the Main Setup menu is displayed. This screen lists the Main Setup menu sub-screens and provides basic system information. Additionally functions for setting the system time and date are offered.

Table 49: Main Setup Menu Sub-Screens and Functions

Function	Description
Product, BIOS & ME Information	Read only field. Displays information about the product, system BIOS and Intel Management Engine (ME) version
CPU Information	Read only field Display information about the processor
Memory Information	Read only field. Displays information about total memory
Board Information	Read only field. Displays information about UUID, serial number and LAN address
System Date	Set System Date
System Time	Set System Time

Figure 43: BIOS Main Menu Screen System Data and Time

BIOS SETUP UTILITY						
Main	Advanced	Power	Boot	Security	Save & Exit	
Product Information						
Product Name	3.5-SBC-TGL					
BIOS Version	TGLUVEX.T00F (x64)					
BIOS Build Date	12/15/2021					
ME Firmware Version	15.0.30.1776 (Corporate)					
CPU Information						
11th Gen Intel® Core™ i5-1145GRE @ 2.60 GHz						
Microcode Revision	9A					
Processor Cores	4 Core(s) / 8 Thread(s)					
Memory Information						
Total Size	15872 MB (DDR4)					
Frequency	2667 MT/s					
Board Information						
UUID	737AC850-2C5A-11B2-8001-00500808D21B				→ ←: Select Screen	
Serial #	00000000				↑ ↓: Select Item	
LAN1 MAC Address	00:50:08:08:D2:1B				Enter: Select	
LAN2 MAC Address	00:50:08:08:D2:1C				+/-: Change Opt.	
System Date	[Tue 12/28/2021]				F1: General Help	
System Time	[13:43:40]				F2: Previous Values	
Access Level	Administrator				F3: Optimized Defaults	
					F4: Save & Exit	
					ESC: Exit	
Version 2.22.1282 Copyright (C) 2021 AMI						

Feature	Option	Description
System Date	[dd/mm/yyyy]	Set the Date. Use Tab to switch between Data elements.
System Time	[hh:mm:ss]	Set the Time. Use Tab to switch between Time elements.

8.2.2. Advanced Setup Menu

The Advanced setup menu provides sub-screens and functions for advanced configurations. The following sub-screen functions are included in the menu:

- ▶ Audio & LAN Configuration
- ▶ Display Configuration
- ▶ CPU Chipset Configuration
- ▶ NVMe Configuration
- ▶ SATA Configuration
- ▶ USB Configuration
- ▶ AMT Configuration
- ▶ Trusted Computing
- ▶ DIO Configuration
- ▶ Network Stack
- ▶ Super IO Configuration
- ▶ H/W Monitor

NOTICE

Setting items on this screen to incorrect values may cause the system to malfunction.

Figure 44: BIOS Advanced Menu

BIOS SETUP UTILITY					
Main	Advanced	Power	Boot	Security	Save & Exit
HD Audio		[Enabled]			
Onboard LAN1 Controller		[Enabled]			
Onboard LAN2 Controller		[Enabled]			
Load Intel I226-IT UNDI*		[Disabled]			
Load Intel I210 UNDI**		[Disabled]			
> Display Configuration					
> CPU Chipset Configuration					
> NVMe Configuration					
> SATA Configuration					
> USB Configuration					
> AMT Configuration					
> Trusted Computing					
> DIO Configuration					
> Network Stack					
> Super IO Configuration					
> H/W Monitor					
				→ ←: Select Screen	
				↑ ↓: Select Item	
				Enter: Select	
				+/-: Change Opt.	
				F1: General Help	
				F2: Previous Values	
				F3: Optimized Defaults	
				F4: Save & Exit	
				ESC: Exit	
Version 2.22.1282 Copyright (C) 2021 AMI					

* This item appears only when enabling Onboard LAN1 Controller.

** This item appears only when enabling Onboard LAN2 Controller.

Feature	Option	Description
HD Audio	[Disabled], [Enabled]	Control Detection of the HD-Audio device. [Disabled]: HDA will be unconditionally disabled. [Enabled]: HDA will be unconditionally enabled.
Onboard LAN1 Controller	[Disabled], [Enabled]	Select whether to enable or disable Onboard LAN1 Controller. Intel-i226-IT.
Onboard LAN2 Controller	[Disabled], [Enabled]	Select whether to enable or disable Onboard LAN2 Controller. Intel-i210.
Load Intel I226-IT UNDI	[Disabled], [Enabled]	Load onboard UNDI (Universal Network Driver Interface) for Intel I226-IT.
Load I210 UNDI Driver	[Disabled], [Enabled]	Load onboard UNDI (Universal Network Driver Interface) for Intel I210.

Figure 45: BIOS Advanced Menu - Display Configuration

BIOS SETUP UTILITY					
Main	Advanced	Power	Boot	Security	Save & Exit
Display Configuration					
Aperture Size		[256MB]			
DVMT Pre-Allocated		[64M]			
DVMT Total Gfx Mem		[256MB]		→ ←: Select Screen	
Active LVDS		[Disabled]		↑ ↓: Select Item	
LVDS Panel Type*		[1366x768 1CH]		Enter: Select	
LVDS Panel Color Depth*		[18Bit]		+/-: Change Opt.	
PWM Backlight Control*		[By External]		F1: General Help	
LVDS Backlight Control Mode*		[PWM]		F2: Previous Values	
LVDS Backlight Control - PWM ⁽¹⁾⁽²⁾		127		F3: Optimized Defaults	
LVDS Backlight Control - Voltage ⁽³⁾		[2.5 V]		F4: Save & Exit	
				ESC: Exit	
Version 2.22.1282 Copyright (C) 2021 AMI					

* These items appear only when enabling Active LVDS.

⁽¹⁾ These items appear only when selecting By External for PWM Backlight Control.

⁽²⁾ This item appears only when selecting PWM for the LVDS Backlight Control Mode.

⁽³⁾ This item appears only when selecting Voltage for the LVDS Backlight Control Mode.

Feature	Option	Description
Aperture Size	[128MB], [256MB], [512MB], [1024MB]	Select the Aperture Size. Note: Above 4GB MMIO BIOS assignment is automatically enabled when selecting 2048MB aperture. To use this feature, please disable CSM Support.
DVMT Pre-Allocated	[32M], [64M], [96M], [128M], [160M]	Select DVMT 5.0 Pre-Allocated (Fixed) Graphics Memory size used by the Internal Graphics Device.
DVMT Total Gfx Mem	[128M], [256M], [MAX]	Select DVMT 5.0 Total Graphic Memory size used by the Internal Graphics Device.
Active LVDS	[Disabled], [Enabled]	Select the Active LVDS Configuration. [Disabled]: don't enable LVDS. [Enabled]: enable LVDS.
LVDS Panel Type	[800x600 1CH], [1024x768 1CH], [1280x1024 2CH], [1366x768 1CH], [1366x768 2CH], [1600x1200 2CH],	LVDS panel by selecting the appropriate setup item.

Feature	Option	Description
	[1920x1080 2CH]	
LVDS Panel Color Depth	[18Bit], [24Bit]	LVDS panel color depth by appropriate setup item.
PWM Backlight Control	[By External], [By Internal]	[By External]: Control by external HW circuit. [By Internal]: Control by LBKL_CTL on the PCH Chipset.
LVDS Backlight Control Mode	[Voltage], [PWM]	CNx LVDS Backlight Power Wafer output control [Voltage]: Pin 1 output [PWM]: Pin 2 output
LVDS Backlight Control - PWM	Value input	0 - 255 PWM Duty
LVDS Backlight Control - Voltage	[0.0 V], [0.5 V], [1.0 V], [1.5 V], [2.0 V], [2.5 V], [3.0 V], [3.5 V], [4.0 V], [4.5 V], [5.0 V]	Min: 0.0 V Max: 5.0 V

Figure 46: BIOS Advanced Menu - CPU Chipset Configuration

BIOS SETUP UTILITY					
Main	Advanced	Power	Boot	Security	Save & Exit
CPU Chipset Configuration					
Intel® SpeedStep™		[Enabled]			
Turbo Mode		[Enabled]			
Hyper-Threading		[Enabled]			
VT-d		[Disabled]		→ ←: Select Screen	
Active Processor Cores		[All]		↑ ↓: Select Item	
Configurable TDP Mode		[28W]		Enter: Select	
Intel (VMX) Virtualization Technology		[Enabled]		+/-: Change Opt.	
Intel Trusted Execution Technology		[Disabled]		F1: General Help	
CPU CrashLog (Device 10)		[Disabled]		F2: Previous Values	
GNA Device (B0:D8:F0)		[Disabled]		F3: Optimized Defaults	
IPU Device (B0:D5:F0)		[Disabled]		F4: Save & Exit	
IPU IMR Configuration**		[IPU Gen]		ESC: Exit	
Version 2.22.1282 Copyright (C) 2021 AMI					

* This item appears only when enabling Intel® SpeedStep™.

** This item appears only when enabling IPU Device.

Feature	Option	Description
Intel® SpeedStep™	[Disabled], [Enabled]	Allows more than two frequency ranges to be supported.
Turbo Mode	[Disabled], [Enabled]	Enable / Disable processor Turbo Mode (requires EMTTM enabled too). AUTO means enabled.
Hyper-Threading	[Disabled], [Enabled]	Enable or Disable Hyper-Threading Technology.
VT-d	[Disabled], [Enabled]	Select whether to enable or disable VT-d capability.
Active Processor Cores	[All], [1], [2], [3]	Number of cores to enable in each processor package.
Configurable TDP Mode	[28W], [15W], [12W]	Configurable TDP Mode as 28W / 15W / 12W TDP selection. Celeron cannot support it.
Intel (VMX) Virtualization Technology	[Disabled], [Enabled]	When enabled, a VMM can utilize the additional hardware capabilities provided by Vanderpool Technology.
Intel Trusted Execution Technology	[Disabled]	Read only item.
CPU CrashLog (Device 10)	[Enabled], [Disabled]	Enable / Disable CPU CrashLog Device.
GNA Device	[Enabled],	Enable / Disable SA GNA Device.

Feature	Option	Description
(B0:D8:F0)	[Disabled]	
IPU Device (B0:D5:F0)	[Enabled], [Disabled]	Enable / Disable SA IPU Device.
IPU IMR Configuration	[IPU Camera], [IPU Gen]	Select the IPU IMR configuration.

Figure 47: BIOS Advanced Menu - NVMe Configuration

BIOS SETUP UTILITY					
Main	Advanced	Power	Boot	Security	Save & Exit
NVMe Configuration					
No NVMe Device Found				→ ←: Select Screen ↑ ↓: Select Item Enter: Select +/-: Change Opt. F1: General Help F2: Previous Values F3: Optimized Defaults F4: Save & Exit ESC: Exit	
Version 2.22.1282 Copyright (C) 2021 AMI					

Figure 48: BIOS Advanced Menu - SATA Configuration

BIOS SETUP UTILITY					
Main	Advanced	Power	Boot	Security	Save & Exit
SATA Configuration					
SATA Controller(s)		[Enabled]		→ ←: Select Screen ↑ ↓: Select Item Enter: Select +/-: Change Opt. F1: General Help F2: Previous Values F3: Optimized Defaults F4: Save & Exit ESC: Exit	
Serial ATA Port 0 (CN27)* Port 0*		Empty [Enabled]			
Serial ATA Port 1 (M.2 Key-B)* Port 1*		Empty [Enabled]			
Version 2.22.1282 Copyright (C) 2021 AMI					

* These items appear only when enabling SATA Controller(s).

Feature	Option	Description
SATA Controller(s)	[Enabled], [Disabled]	Enable / Disable SATA Device.
Port 0, 1	[Disabled], [Enabled]	Select whether to enable or disable SATA Controller Port 0, 1.

Figure 49: BIOS Advanced Menu - USB Configuration

BIOS SETUP UTILITY					
Main	Advanced	Power	Boot	Security	Save & Exit
USB Configuration					
USB Devices: 1 Keyboard				→ ←: Select Screen ↑ ↓: Select Item Enter: Select +/-: Change Opt. F1: General Help F2: Previous Values F3: Optimized Defaults F4: Save & Exit ESC: Exit	
XHCI Hand-off		[Enabled]			
USB Mass Storage Driver Support		[Enabled]			
Version 2.22.1282 Copyright (C) 2021 AMI					

Feature	Option	Description
XHCI Hand-off	[Enabled], [Disabled]	This is a workaround for OSes without XHCI hand-off support. The XHCI ownership change should be claimed by XHCI driver.
USB Mass Storage Driver Support	[Disabled], [Enabled]	Enable / Disable USB Mass Storage Driver Support.

Figure 50: BIOS Advanced Menu - AMT Configuration

BIOS SETUP UTILITY					
Main	Advanced	Power	Boot	Security	Save & Exit
AMT Configuration					
AMT BIOS Features		[Enabled]		→ ←: Select Screen ↑ ↓: Select Item Enter: Select +/-: Change Opt. F1: General Help F2: Previous Values F3: Optimized Defaults F4: Save & Exit ESC: Exit	
Unconfigure ME*		[Disabled]			
Version 2.22.1282 Copyright (C) 2021 AMI					

* This item is selectable only when enabling AMT BIOS Features.

Feature	Option	Description
AMT BIOS Features	[Disabled], [Enabled]	When disabled AMT BIOS Features are no longer supported and user is no longer able to access MEBx Setup. Note: This option does not disable Manageability Features in FW.
Unconfigure ME	[Disabled], [Enabled]	OEMFlag Bit 15: Unconfigure ME with resetting MEBx password to default.

Figure 51: BIOS Advanced Menu - Trusted Computing

BIOS SETUP UTILITY					
Main	Advanced	Power	Boot	Security	Save & Exit
Configuration					
Security Device Support		[Disabled]			
No Security Device Found				→ ←: Select Screen ↑ ↓: Select Item Enter: Select +/-: Change Opt. F1: General Help F2: Previous Values F3: Optimized Defaults F4: Save & Exit ESC: Exit	
Version 2.22.1282 Copyright (C) 2021 AMI					

Feature	Option	Description
Security Device Support	[Disabled], [Enabled]	Enable or Disable BIOS support for security device. O.S. will not show Security Device. TCG EFI protocol and INT1A interface will not be available.

Figure 52: BIOS Advanced Menu - DIO Configuration

BIOS SETUP UTILITY					
Main	Advanced	Power	Boot	Security	Save & Exit
DIO Configuration					
User Configuration		[Disabled]			
Force unlock on all GPIO pads		[Enabled]			
DIO_0*		[Output High]			
DIO_1*		[Output High]			
DIO_2*		[Output High]			
DIO_3*		[Output High]			
DIO_4*		[Output High]			
DIO_5*		[Output High]			
DIO_6*		[Output High]			
DIO_7*		[Output High]			
DIO_0 Value		1		→ ←: Select Screen ↑ ↓: Select Item Enter: Select +/-: Change Opt. F1: General Help F2: Previous Values F3: Optimized Defaults F4: Save & Exit ESC: Exit	
DIO_1 Value		1			
DIO_2 Value		1			
DIO_3 Value		1			
DIO_4 Value		1			
DIO_5 Value		1			
DIO_6 Value		1			
DIO_7 Value		1			
Version 2.22.1282 Copyright (C) 2021 AMI					

* These items appear only when enabling User Configuration.

Feature	Option	Description
User Configuration	[Enabled], [Disabled]	User can set the DO pin output value.
Force unlock on all GPIO pads	[Disabled], [Enabled]	If Enabled BIOS will force all GPIO pads to be in unlocked state.
DIO_0..7	[Output Low], [Output High], [Input]	Setting the DO pin output value.

Figure 53: BIOS Advanced Menu - Network Stack

BIOS SETUP UTILITY					
Main	Advanced	Power	Boot	Security	Save & Exit
IPv4 PXE Support		[Enabled]			
IPv6 PXE Support		[Disabled]			
				→ ←: Select Screen ↑ ↓: Select Item Enter: Select +/-: Change Opt. F1: General Help F2: Previous Values F3: Optimized Defaults F4: Save & Exit ESC: Exit	
Version 2.22.1282 Copyright (C) 2021 AMI					

Feature	Option	Description
IPv4 PXE Support	[Disabled], [Enabled]	Enable / Disable IPv4 PXE boot support. If disabled, IPv4 PXE boot support will not be available.
IPv6 PXE Support	[Disabled], [Enabled]	Enable / Disable IPv6 PXE boot support. If disabled, IPv6 PXE boot support will not be available.

Figure 54: BIOS Advanced Menu - Super IO Configuration

BIOS SETUP UTILITY					
Main	Advanced	Power	Boot	Security	Save & Exit
Super IO Configuration					
> Serial Port 1 Configuration > Serial Port 2 Configuration				→ ←: Select Screen ↑ ↓: Select Item Enter: Select +/-: Change Opt. F1: General Help F2: Previous Values F3: Optimized Defaults F4: Save & Exit ESC: Exit	
Version 2.22.1282 Copyright (C) 2021 AMI					

Figure 55: BIOS Advanced Menu - Super IO Configuration - Serial Port 1 Configuration

BIOS SETUP UTILITY					
Main	Advanced	Power	Boot	Security	Save & Exit
Super Port 1 Configuration					
Serial Port		[Enabled]		→ ←: Select Screen ↑ ↓: Select Item Enter: Select +/-: Change Opt. F1: General Help F2: Previous Values F3: Optimized Defaults F4: Save & Exit ESC: Exit	
Device Settings*		IO=3F8h; IRQ=4;			
Change Setting*		[Auto]			
Serial Port 1 Type*		[RS232]			
RS485 Deplx Mode*(1)		[Half Duplex]			
RS485 Auto Flow Control*(1)(3)		[Disabled]			
RS485/422 Receiver Termination*(2)		[Enabled]			
Version 2.22.1282 Copyright (C) 2021 AMI					

* These items appear only when enabling Serial Port.

(1) These items appear only when selecting RS485 for the Serial Port 1 Type.

(2) This item appears only when selecting RS485 or RS422 for the Serial Port 1 Type.

(3) This item appear only when selecting Half Duplex for RS485 Auto Flow Control.

Feature	Option	Description
Serial Port	[Disabled], [Enabled]	Enable or Disable Serial Port (COM).
Change Settings	[Auto], [IO=3F8h; IRQ=4;], [IO=3F8h; IRQ=3, 4, 5, 6, 7, 9, 10, 11, 12;],	Select an optional setting for Super IO device.

Feature	Option	Description
	[IO=3E8h; IRQ=3, 4, 5, 6, 7, 9, 10, 11, 12;], [IO=2E8h; IRQ=3, 4, 5, 6, 7, 9, 10, 11, 12;]	
Serial Port 1 Type	[RS232], [RS422], [RS485]	Select an appropriate type for Serial Port 1.
RS485 Duplex Mode	[Half Duplex], [Full Duplex]	Select an appropriate RS485 Duplex Mode.
RS485 Auto Flow Control	[Disabled], [Enabled]	Select whether to enable or disable RS485 Auto Flow Control.
RS485/422 Receiver Termination	[Disabled], [Enabled]	Select whether to enable or disable RS485/422 Receiver Termination.

Figure 56: BIOS Advanced Menu - Super IO Configuration - Serial Port 2 Configuration

BIOS SETUP UTILITY					
Main	Advanced	Power	Boot	Security	Save & Exit
Super Port 2 Configuration					
Serial Port		[Enabled]		→ ←: Select Screen	
Device Settings*		IO=2F8h; IRQ=3;		↑ ↓: Select Item	
Change Setting*		[Auto]		Enter: Select	
Serial Port 2 Type*		[RS232]		+/-: Change Opt.	
RS485 Deplx Mode*(1)		[Half Duplex]		F1: General Help	
RS485 Auto Flow Control*(1)(3)		[Disabled]		F2: Previous Values	
RS485/422 Receiver Termination*(2)		[Enabled]		F3: Optimized Defaults	
				F4: Save & Exit	
				ESC: Exit	
Version 2.22.1282 Copyright (C) 2021 AMI					

* These items appear only when enabling Serial Port.

(1) These items appear only when selecting RS485 for the Serial Port 2 Type.

(2) This item appears only when selecting RS485 or RS422 for the Serial Port 2 Type.

(3) This item appear only when selecting Half Duplex for RS485 Auto Flow Control.

Feature	Option	Description
Serial Port	[Disabled], [Enabled]	Enable or Disable Serial Port (COM).
Change Settings	[Auto], [IO=2F8h; IRQ=3;], [IO=2F8h; IRQ=3, 4, 5, 6, 7, 9, 10, 11, 12;], [IO=3E8h; IRQ=3, 4, 5, 6, 7, 9, 10, 11, 12;], [IO=2E8h; IRQ=3, 4, 5, 6, 7, 9, 10, 11, 12;]	Select an optional setting for Super IO device.
Serial Port 2 Type	[RS232], [RS422], [RS485]	Select an appropriate type for Serial Port 2.

Feature	Option	Description
RS485 Duplex Mode	[Half Duplex], [Full Duplex]	Select an appropriate RS485 Duplex Mode.
RS485 Auto Flow Control	[Disabled], [Enabled]	Select whether to enable or disable RS485 Auto Flow Control.
RS485/422 Receiver Termination	[Disabled], [Enabled]	Select whether to enable or disable RS485/422 Receiver Termination.

Figure 57: BIOS Advanced Menu - H/W Monitor

BIOS SETUP UTILITY					
Main	Advanced	Power	Boot	Security	Save & Exit
PC Health Status > Smart FAN Configuration					
CPU Temperature		: +36 C		→ ←: Select Screen	
System Temperature		: +32 C		↑ ↓: Select Item	
CPU Fan Speed		: 7258 RPM		Enter: Select	
+12VIN		: +12.063 V		+/-: Change Opt.	
+3.3V		: +3.312 V		F1: General Help	
+5V		: +5.039 V		F2: Previous Values	
+3.3VA		: +3.296 V		F3: Optimized Defaults	
+VRTC		: +3.104 V		F4: Save & Exit	
				ESC: Exit	
Version 2.22.1282 Copyright (C) 2021 AMI					

Figure 58: BIOS Advanced Menu - H/W Monitor - Smart FAN Configuration

BIOS SETUP UTILITY					
Main	Advanced	Power	Boot	Security	Save & Exit
Smart FAN Configuration					
CPU FAN Setting		[Manual]			
Manual Duty*		255		→ ←: Select Screen	
1st Boundary Temperature**		30		↑ ↓: Select Item	
1st FAN Speed**		50		Enter: Select	
2nd Boundary Temperature**		40		+/-: Change Opt.	
2nd FAN Speed**		100		F1: General Help	
3rd Boundary Temperature**		50		F2: Previous Values	
3rd FAN Speed**		150		F3: Optimized Defaults	
4th Boundary Temperature**		60		F4: Save & Exit	
4th FAN Speed**		200		ESC: Exit	
Version 2.22.1282 Copyright (C) 2021 AMI					

* This item appears only when selecting Manual for CPU FAN Setting.

** These items appear only when selecting Smart for CPU FAN Setting.

Feature	Option	Description
CPU FAN Setting	[Manual], [Smart]	Switch the CPU FAN control mode.
Manual Duty	Value Input	0 - 255 PWM Duty
1st / 2nd / 3rd / 4th Boundary	Value Input	1 - 100 C

Feature	Option	Description
Temperature		
1st / 2nd / 3rd / 4th FAN Speed	Value Input	0 – 255 PWM Duty

8.2.3. Power Setup Menu

The Power setup menu provides functions and a sub-screen for power configurations. The following sub-screen function is included in the menu:

- ▶ WatchDog Timer Configuration

Figure 59: BIOS Power Setup Menu

BIOS SETUP UTILITY					
Main	Advanced	Power	Boot	Security	Save & Exit
Power Configuration					
ACPI Sleep State		[S3 (Suspend to RAM)]			
Restore AC Power Loss		[Power Off]			
Power Saving Mode		[Disabled]			
Resume Event Control					
ResumeLan I226-IT		[Disabled]			
ResumeLan I210		[Disabled]			
Resume By PCI-E Device		[Disabled]		→ ←: Select Screen	
Resume By Ring Device		[Disabled]		↑ ↓: Select Item	
Resume By RTC Alarm		[Disabled]		Enter: Select	
RTC Alarm Mode ⁽¹⁾		[Fixed Time]		+/-: Change Opt.	
Time(Days)Alarm ⁽²⁾		0		F1: General Help	
Time(hh)Alarm ⁽¹⁾		0		F2: Previous Values	
Time(mm)Alarm ⁽¹⁾		1		F3: Optimized Defaults	
Time(ss)Alarm ⁽¹⁾		0		F4: Save & Exit	
> WatchDog Timer Configuration				ESC: Exit	
Version 2.22.1282 Copyright (C) 2021 AMI					

⁽¹⁾ These items appear only when enabling Resume By RTC Alarm.

⁽²⁾ This item appears only when enabling Resume By RTC Alarm and selecting Fixed Time for RTC Alarm Mode.

Feature	Option	Description
ACPI Sleep State	[Suspend Disabled], [S3 (Suspend to RAM)]	Select the highest ACPI sleep state the system will enter when the SUSPEND button is pressed.
Restore AC Power Loss	[Power Off], [Power On], [Last State]	Select AC power state when power is re-applied after a power failure.
Power Saving Mode	[Disabled], [EUP Enabled]	Configure the Power Saving Mode configuration. EUP AUX Power: Save Power for USB and PCIE-Slot components. EUP SOC Power: Save Power for USB, PCIE-Slot, Lan and Chipset-SOC components.
ResumeLan I226-IT	[Disabled], [OS-Driver], [FW-MagicPacket]	Select whether to enable Wake from LAN Device Intel I226-IT.

Feature	Option	Description
ResumeLan I210	[Disabled], [OS-Driver], [FW-MagicPacket]	Select whether to enable Wake from LAN Device Intel I210.
Resume By PCI-E Device	[Disabled], [Enabled]	Select whether to enable Wake from PCI-E Device.
Resume By Ring Device	[Disabled], [Enabled]	Select whether to enable Wake from Ring Device.
Resume By RTC Alarm	[Disabled], [Enabled]	Select whether to enable Wake Up on Alarm, to turn on your system on a special day of the month.
RTC Alarm Mode	[Fixed Time], [After S4/S5]	Select an appropriate RTC Alarm Mode.
Date(Days)Alarm	Value Input	0 - 31, 0 stands for every day.
Time(hh)Alarm	Value Input	0 - 23
Time(mm)Alarm	Value Input	0 - 59
Time(ss)Alarm	Value Input	0 - 59

Figure 60: BIOS Power Setup Menu - WatchDog Timer Configuration

BIOS SETUP UTILITY					
Main	Advanced	Power	Boot	Security	Save & Exit
WatchDog Timer Configuration					
WDT Function		[Disabled]		→ ←: Select Screen	
WDT Count Mode*		[Minute]		↑ ↓: Select Item	
WDT Timer*		3		Enter: Select	
				+/-: Change Opt.	
				F1: General Help	
				F2: Previous Values	
				F3: Optimized Defaults	
				F4: Save & Exit	
				ESC: Exit	
Version 2.22.1282 Copyright (C) 2021 AMI					

* These items appear only when enabling WDT Function.

Feature	Option	Description
WDT Function	[Disabled], [Enabled]	Select whether to enable or disable WatchDog Timer function.
WDT Count Mode	[Second], [Minute]	Select WatchDog Count Mode: Second or Minute.
WDT Timer	Value Input	Count 0 - 255

8.2.4. Boot Setup Menu

The boot setup menu lists the for boot device priority order, that is generated dynamically.

Figure 61: BIOS Boot Setup Menu

BIOS SETUP UTILITY					
Main	Advanced	Power	Boot	Security	Save & Exit
Boot Configuration					
Full Screen LOGO Display		[Disabled]			
Setup Prompt Timeout		1		→ ←: Select Screen	
Bootup NumLock State		[On]		↑ ↓: Select Item	
CSM Support		[Disabled]		Enter: Select	
Boot Option Filter		[UEFI Only]		+/-: Change Opt.	
Boot Option Priorities				F1: General Help	
Boot Option #1		[UEFI: Built-in EFI Shell]		F2: Previous Values	
				F3: Optimized Defaults	
				F4: Save & Exit	
				ESC: Exit	
Version 2.22.1282 Copyright (C) 2021 AMI					

Feature	Option	Description
Full Screen LOGO Display	[Disabled], [Enabled]	Select whether to enable or disable to display logo screen.
Setup Prompt Timeout	Value Input	Number of seconds to wait for setup activation key. 65535(0xFFFF) means indefinite waiting.
Bootup NumLock State	[On], [Off]	This field indicates the state of the NumLock feature of the keyboard after Startup. [On]: The keys on the keypad will act as numeric keys. [Off]: The keys on the keypad will act as cursor keys.
CSM Support	[Disabled]	Read only item
Boot Option Filter	[UEFI only]	Read only item
Boot Option #1	[UEFI: Built-in EFI Shell], [Disabled]	Select an option for first boot device.

8.2.5. Security Setup Menu

The Security setup menu provides information about the passwords and functions for specifying the security settings. The passwords are case-sensitive. The 3.5"-SBC-TGL provides no factory-set passwords.

NOTICE

If there is already a password installed, the system asks for this first. To clear a password, simply enter nothing and acknowledge by pressing <RETURN>. To set a password, enter it twice and acknowledge by pressing <RETURN>.

Figure 62: BIOS Security Setup Menu

BIOS SETUP UTILITY					
Main	Advanced	Power	Boot	Security	Save & Exit
Password Description					
If ONLY the Administrator's password is set, then this only limits access to Setup and is only asked for when entering Setup					
If ONLY the User's password is set, then this is a power on password and must be entered to boot or enter Setup. In Setup the User will have Administrator rights					
The password length must be in the following range:					
Minimum Length		3		→ ←: Select Screen	
Maximum length		20		↑ ↓: Select Item	
Administrator Password				Enter: Select	
User Password				+/-: Change Opt.	
> Secure Boot				F1: General Help	
				F2: Previous Values	
				F3: Optimized Defaults	
				F4: Save & Exit	
				ESC: Exit	
Version 2.22.1282 Copyright (C) 2021 AMI					

Feature	Description
Administrator Password	Set administrator password
User Password	Set user password



If only the administrator's password is set, then only access to setup is limited. The password is only entered when entering setup.

If only the user's password is set, then the password is a power on password and must be entered to boot or enter setup. Within the setup menu the user has administrator rights.

Password length requirements are maximum 20 characters and minimum 3 characters.

Figure 63: BIOS Security Setup Menu – Secure Boot

BIOS SETUP UTILITY					
Main	Advanced	Power	Boot	Security	Save & Exit
System Mode		Setup			
Secure Boot		[Disabled] Not Active		→ ←: Select Screen ↑ ↓: Select Item Enter: Select +/-: Change Opt. F1: General Help F2: Previous Values F3: Optimized Defaults F4: Save & Exit ESC: Exit	
Secure Boot Mode		[Standard]			
> Restore Factory Keys*					
> Reset To Setup Mode*					
> Key Management*					
Version 2.22.1282 Copyright (C) 2021 AMI					

*These items are selectable only when selecting Custom for Secure Boot Mode.

Feature	Option	Description
Secure Boot	[Disabled], [Enabled]	Secure Boot feature is Active if Secure Boot is Enabled, Platform Key (PK) is enrolled and the System is in User mode. The mode change requires platform reset.
Secure Boot Mode	[Standard], [Custom]	Secure Boot mode options: Standard or Custom. In Custom mode, Secure Boot Policy variables can be configured by a physically present user without full authentication.
Restore Factory Keys	[Yes], [No]	Force System to User Mode. Install factory default Secure Boot key databases.
Reset to Setup Mode	[Yes], [No]	Delete all Secure Boot key databases from NVRAM.

Figure 64: BIOS Security Setup Menu – Secure Boot – Key Management

BIOS SETUP UTILITY						
Main	Advanced	Power	Boot	Security	Save & Exit	
Vendor Keys		Valid				
Factory Key Provision		[Disabled]				
> Restore Factory Keys						
> Reset To Setup Mode						
> Export Secure Boot variables						
> Enroll Efi Image						
Device Guard Ready						
> Remove 'UEFI CA' from DB						
> Restore DB defaults						→ ←: Select Screen ↑ ↓: Select Item
Secure Boot variable	Size	Keys	Key Source	Enter: Select		
> Platform Key (PK)	862	1	Test (AMI)	+/-: Change Opt.		
> Key Exchange Keys	1560	1	Factory	F1: General Help		
> Authorized Signatures	3143	2	Factory	F2: Previous Values		
> Forbidden Signatures	3724	77	Factory	F3: Optimized Defaults		
> Authorized TimeStamps	0	0	No Keys	F4: Save & Exit		
> OsRecovery Signatures	0	0	No Keys	ESC: Exit		
Version 2.22.1282 Copyright (C) 2021 AMI						

Feature	Option	Description
Factory Key Provision	[Disabled], [Enabled]	Install factory default Secure Boot keys after the platform reset and while the System is in Setup mode.
Reset Factory Keys	[Yes], [No]	Force System to User Mode. Install factory default Secure Boot key databases.
Reset to Setup Mode	[Yes], [No]	Delete all Secure Boot key databases from NVRAM.
Export Secure Boot variables	Select a File system	Copy NVRAM content of Secure Boot variables to files in a root folder on a file system device.
Enroll Efi Image	Select a File system	Allow the image to run in Secure Boot mode. Enroll SHA256 Hash certificate of a PE image into Authorized Signature Database (db).
Remove 'UEFI CA' from DB	[Yes], [No]	Device Guard ready system must not list 'Microsoft UEFI CA' Certificate in Authorized Signature database (db).
Restore DB defaults	[Yes], [No]	Restore DB variable to factory defaults.
Platform Key (PK)	[Details], [Export], [Update], [Delete]	Enroll Factory Defaults or load certificates from a file: 1. Public Key Certificate: (a) EFI_SIGNATURE_LIST (b) EFI_CERT_X509 (DER)

Feature	Option	Description
Key Exchange Keys	[Details], [Export], [Update], [Append], [Delete]	(c) EFI_CERT_RSA2048 (bin) (d) EFI_CERT_SHAXXX 2. Authenticated UEFI Variable 3. EFI PE / COFF Image (SHA256) Key Source: Factory, External, Mixed
Authorized Signatures	[Details], [Export], [Update], [Append], [Delete]	
Forbidden Signatures	[Details], [Export], [Update], [Append], [Delete]	
Authorized TimeStamps	[Update], [Append]	
OsRecovery Signatures	[Update], [Append]	

8.2.5.1. Remember the password

It is highly recommended to keep a record of all passwords in a safe place. Forgotten passwords results in being locked out of the system.

If the system cannot be booted because the User Password or the Supervisor Password are not know, contact Kontron Support for further assistance.



HDD security passwords cannot be cleared using the above method.

8.2.6. Save & Exit Setup Menu

The exit setup menu provides functions for handling changes made to the UEFI BIOS settings and the exiting of the setup program.

Figure 65: BIOS Save & Exit Setup Menu

BIOS SETUP UTILITY					
Main	Advanced	Power	Boot	Security	Save & Exit
Save Changes and Reset					
Discard Changes and Reset					
Save Options					→ ←: Select Screen
Save Changes					↑ ↓: Select Item
Discard Changes					Enter: Select
Restore Defaults					+/-: Change Opt.
					F1: General Help
					F2: Previous Values
					F3: Optimized Defaults
					F4: Save & Exit
					ESC: Exit
Version 2.22.1282 Copyright (C) 2021 AMI					

Feature	Description
Save Changes and Reset	Reset the system after saving the changes.
Discard Changes and Reset	Reset system setup without saving any changes.
Save Changes	Save Changes done so far to any of the setup options.
Discard Changes	Discard Changes done so far to any of the setup options.
Restore Defaults	Restore / Load Default values for all the setup options.

Appendix A: List of Acronyms



The following table does not contain the complete acronyms used in signal names, signal type definitions or similar. A description of the signals is included in the I/O Connector and Internal connector chapters within this user guide.

Table 50: List of Acronyms

2D	Two-Dimensional
3D	Three-Dimensional
AT	Advanced Technology
ATX	Advanced Technology eXtended
BGA	Ball Grid Array
BIOS	Basic Input / Output System
BSP	Board Support Package
CMOS	Complementary Metal Oxide Semiconductor
CPU	Central Processing Unit
DC	Direct Current
DDC	Display Data Channel
DIO	Digital Input / Output
DP	DisplayPort
ECC	Error-Correcting Code
EEE	Electrical and Electronic Equipment
EOS	Electrical OverStress
ESD	ElectroStatic Discharge
GbE	Gigabit Ethernet
HDD	Hard Disk Drive
HDMI	High Definition Multimedia Interface
LAN	Local Area Network
LED	Light Emitting Device
LVDS	Low-Voltage Differential Signaling
ME F/W	Management Engine Firmware
mPCIe	mini Peripheral Component Interconnect express
NGFF	Next Generation Form Factor
PC-AT	Personal Computer - Advanced Technology
PCB	Printed Circuit Board
PSU	Power Supply Unit
PVC	PolyViny Chloride
PWM	Pulse Width Modulation
RAM	Random Access Memory
ROM	Read-Only Memory

RTC	Real-Time Clock
SATA	Serial Advanced Technology Attachment
SD	Secure Digital memory card
SDP	Serial Download Protocol
SELV	Safety Extra-Low Voltage
SIM	Subscriber Identity Module
SMBus	System Management Bus
SoC	System on Chip
SO-DIMM	Small Outline Dual In-line Memory Module
SPD	Serial Presence Detect
SPI	Serial Peripheral Interface
TDP	Thermal Design Power
TPM	Trusted Platform Module
UEFI	Unified Extensible Firmware Interface
USB	Universal Serial Bus
UTP	Update Transfer Protocol
VGA	Video Graphics Array
WDT	WatchDog Timer
WEEE	Waste Electrical and Electronic Equipment



About Kontron

Kontron is a global leader in IoT / Embedded Computing Technology (ECT) and offers individual solutions in the areas of Internet of Things (IoT) and Industry 4.0 through a combined portfolio of hardware, software and services. With its standard and customized products based on highly reliable state-of-the-art technologies, Kontron provides secure and innovative applications for a wide variety of industries. As a result, customers benefit from accelerated time-to-market, lower total cost of ownership, extended product lifecycles and the best fully integrated applications.

For more information, please visit: www.kontron.com



Global Headquarters

Kontron Europe GmbH

Gutenbergstraße 2
85737 Ismaning
Germany
Tel.: +49 821 4086-0
Fax: +49 821 4086-111
info@kontron.com