

EC-7100

Edge Computer

User's Manual

Version 1.0
(July 2020)



Copyright

© 2020 IBASE Technology, Inc. All rights reserved.

No part of this publication may be reproduced, copied, stored in a retrieval system, translated into any language or transmitted in any form or by any means, electronic, mechanical, photocopying, or otherwise, without the prior written consent of IBASE Technology, Inc. (hereinafter referred to as "IBASE").

Disclaimer

IBASE reserves the right to make changes and improvements to the products described in this document without prior notice. Every effort has been made to ensure the information in the document is correct; however, IBASE does not guarantee this document is error-free.

IBASE assumes no liability for incidental or consequential damages arising from misapplication or inability to use the product or the information contained herein, nor for any infringements of rights of third parties, which may result from its use.

Trademarks

All the trademarks, registrations and brands mentioned herein are used for identification purposes only and may be trademarks and/or registered trademarks of their respective owners.

Compliance



This product conforms to health, safety, and environmental protection standards for items sold within the European Economic Area (EEA).



This product has been tested and found to comply with the limits for a Class B device, pursuant to Part 15 of the FCC Rules. These limits are designed to provide reasonable protection against harmful interference in a residential installation. This equipment generates, uses and can radiate radio frequency energy and, if not installed and used in accordance with manufacturer's instructions, may cause harmful interference to radio communications.

WEEE



This product must not be disposed of as normal household waste, in accordance with the EU directive of for waste electrical and electronic equipment (WEEE - 2012/19/EU). Instead, it should be disposed of by returning it to a municipal recycling collection point. Check local regulations for disposal of electronic products.

Green IBASE



This product is compliant with the current RoHS restrictions and prohibits use of the following substances in concentrations exceeding 0.1% by weight (1000 ppm) except for cadmium, limited to 0.01% by weight (100 ppm).

- Lead (Pb)
- Mercury (Hg)
- Cadmium (Cd)
- Hexavalent chromium (Cr6+)
- Polybrominated biphenyls (PBB)
- Polybrominated diphenyl ether (PBDE)

Important Safety Information

Carefully read the precautions before using the device.

Environmental conditions:

- Lay the device horizontally on a stable and solid surface in case the device may fall, causing serious damage.
- Leave plenty of space around the device and do not block the openings for ventilation. **NEVER DROP OR INSERT ANY OBJECTS OF ANY KIND INTO THE VENTILATION OPENINGS.**
- Use this product in environments with ambient temperatures between 0°C and 45°C.
- **DO NOT LEAVE THIS DEVICE IN AN ENVIRONMENT WHERE THE STORAGE TEMPERATURE MAY IS BELOW -20° C OR ABOVE 80° C.** This could damage the device. The device must be used in a controlled environment.

Care for your IBASE products:

- Before cleaning the device, turn it off and unplug all cables such as power in case a small amount of electrical current may still flow.
- Use neutral cleaning agents or diluted alcohol to clean the device chassis with a cloth. Then wipe the chassis with a dry cloth.
- Vacuum the dust with a computer vacuum cleaner to prevent the air vent or slots from being clogged.



WARNING

Attention during use:

- Do not use this product near water.
- Do not spill water or any other liquids on your device.
- Do not place heavy objects on the top of the device.
- Operate this device from the type of power indicated on the marking label. If you are not sure of the type of power available, consult your distributor or local power company.
- Do not walk on the power cord or allow anything to rest on it.
- If you use an extension cord, make sure that the total ampere rating of the product plugged into the extension cord does not exceed its limits.

Avoid Disassembly

Do not disassemble, repair or make any modification to the device. Doing so could generate hazards and cause damage to the device, even bodily injury or property damage, and will void any warranty.



CAUTION

There is danger of explosion if internal lithium-ion battery is replaced by an incorrect type. Replace only with the same or equivalent type recommended by the manufacturer. Dispose of used batteries according to the manufacturer's instructions.

Warranty Policy

- **IBASE standard products:**

24-month (2-year) warranty from the date of shipment. If the date of shipment cannot be ascertained, the product serial numbers can be used to determine the approximate shipping date.
- **3rd-party parts:**

12-month (1-year) warranty from delivery for the 3rd-party parts that are not manufactured by IBASE, such as CPU, CPU cooler, memory, storage devices, power adapter, panel and touchscreen.
- * PRODUCTS, HOWEVER, THAT FAIL DUE TO MISUSE, ACCIDENT, IMPROPER INSTALLATION OR UNAUTHORIZED REPAIR SHALL BE TREATED AS OUT OF WARRANTY AND CUSTOMERS SHALL BE BILLED FOR REPAIR AND SHIPPING CHARGES.

Technical Support & Services

1. Visit the IBASE website at www.ibase.com.tw to find the latest information about the product.
2. If you need any further assistance from your distributor or sales representative, prepare the following information of your product and elaborate upon the problem.
 - Product model name
 - Product serial number
 - Detailed description of the problem
 - The error messages in text or in screenshots if there is any
 - The arrangement of the peripherals
 - Software in use (such as OS and application software, including the version numbers)
3. If repair service is required, you can download the RMA form at <http://www.ibase.com.tw/english/Supports/RMAService/>. Fill out the form and contact your distributor or sales representative.

Table of Contents

Chapter 1	General Information.....	1
1.1	Introduction	2
1.2	Features.....	2
1.3	Packing List	3
1.4	Specifications.....	3
1.5	Product View.....	5
1.6	Dimensions	7
Chapter 2	Hardware Installation & Motherboard Information	8
2.1	Installation / Replacement.....	9
2.1.1	Memory	10
2.1.2	SSD.....	11
2.1.3	Mini-PCIe & M.2 Cards	12
2.1.4	WiFi / 3G / 4G Antenna Installation.....	13
2.2	Pin Assignment for DC Power Input Connector	14
2.3	Pin Assignment for External Power Input Connector	14
2.4	Pin Assignment for COM1 RS-232 Port	15
2.5	Setting the Jumpers	16
2.6	Jumper & Connector Locations on Motherboard	17
2.7	Jumpers Quick Reference.....	18
2.7.1	Clearing CMOS Data (JBAT2)	18
2.7.2	Clearing ME Register (JBAT1)	18
2.8	Connectors Quick Reference	19
2.8.1	Front Panel Setting Connector (J1)	20
2.8.2	USB 2.0 Connector (J3, J5)	20
2.8.3	CPU Fan Power Connector (CPU_FAN1, CPU_FAN2).....	21
2.8.4	Digital I/O Connector (J7).....	21
2.8.5	External Power Bottom Connector (J10)	22
2.8.6	COM1 RS-232 Port (CN6).....	22
2.8.7	SATA Connector (J11, J12)	23
2.8.8	MXM Connector (CN4).....	23

Chapter 3	Driver Installation	26
3.1	Introduction	27
3.2	Intel® Chipset Software Installation Utility	27
3.3	HD Audio Driver Installation	28
3.4	LAN Driver Installation	28
3.5	Intel® Management Engine Components Drivers Installation.....	29
3.6	NVIDIA® GeForce® MXM Driver Installation	29
Chapter 4	BIOS Setup	30
4.1	Introduction	31
4.2	BIOS Setup.....	31
4.3	Main Settings	32
4.4	Advanced Settings	32
4.4.1	CPU Configuration.....	33
4.4.2	Power & Performance.....	34
4.4.3	PCH-FW Configuration	34
4.4.4	ACPI Settings	35
4.4.5	iSmart Controller.....	36
4.4.6	NCT5523D Super IO Configuration	37
4.4.7	NCT5523D Hardware Monitor	38
4.4.8	Network Stack Configuration	38
4.4.9	CSM Configuration	39
4.4.10	NVMe Configuration	39
4.4.11	USB Configuration.....	40
Appendix	41
A.	I/O Port Address Map.....	42
B.	Interrupt Request Lines (IRQ)	44
C.	Watchdog Timer Configuration.....	45

Chapter 1

General Information

The information provided in this chapter includes:

- Features
- Packing List
- Accessories
- Specifications
- Product View
- Dimensions

1.1 Introduction

The EC-7100 edge computer is built with the high-performance NVIDIA GTX 1080 graphics card equipped with 2560 CUDA cores, 8GB GDDR5X memory and up to 9 TFLOPS capability. The EC-7100 platform combines the computing power of the NVIDIA's MXM GPU hardware accelerator and the 7th Generation Intel® Core™ processor family to leverage streaming data for artificial intelligence-driven applications in the transportation, automation and retail industries.

The EC-7100 measures 340 x 170 x 79mm and is suited for most indoor installations. The standard model comes installed with an Intel® Core™ i7-7700 3.0GHz processor, 16GB DDR4 system memory that is expandable to 32GB, and one 128GB SATA-III SSD storage and a spare connector for a second drive. Four DisplayPort 1.4 interfaces are available, together with expansion provided by M.2 sockets, a full-size mPCIe and a SIM card slot.



1.2 Features

- 7th Generation Intel® Core™ i7/i5/i3 / Pentium® / Celeron® Processors
- NVIDIA GeForce GTX 1080 MXM (Type-B, Up to 150W)
- 2x DDR4 2133 SO-DIMM, dual channel, Max 32GB
- 4x DP 1.4, 1x HDMI 1.4 for console
- 1x Mini PCI-E (full-size) for Wi-Fi, Bluetooth, 4G LTE or capture card options
- 1x M.2 B-Key (3042) for storage or 4G LTE options
- 1x M.2 M-Key (2280) for SSD expansion
- 1x 2.5" 128GB SATA-III SSD and 1x 2.5" SATA-III for storage expansion

1.3 Packing List

Your product package should include the items listed below. If any of the items below is missing, contact the distributor or the dealer from whom you purchased the product.

- EC-7100 Edge Computer
- Power Adapter
- Power Cord
- Terminal Block
- M.2 screw

1.4 Specifications

Product	EC-7100
System	
Mainboard	MBD614
Operating System	Windows 10 & Linux
CPU	Intel® 7 th Gen. Core™ Desktop processor LGA1151 (socket H4)
Chipset	H110 PCH
Memory	2 x DDR4 SO-DIMM 2133 MHz, expandable up to 32GB
Graphics	NVIDIA® GeForce® GTX 1080 8GD5X / GeForce® GTX 1060 6GD5 / GeForce® GTX 1050-LN 4GD5
LAN Controller	1 x Intel® I219V GbE LAN Controller
Super I/O	Nuvoton NCT5523D
Storage	1 x M.2 M2280 slot
Power Requirement	DC-In 19V
Power Supply	270W power adapter
Watchdog	Watchdog Timer 256 segments, 0, 1, 2...255 sec/min
iControl	Yes
Chassis	Aluminum and SGCC, black & white
Mounting	Slim design with wall mount holes
Dimensions (W x H x D)	333 x 74 x 170 mm

Certificate	CE, FCC class B, UL, CCC
I/O Ports	
Power Jack	1 x DC-In power jack
External Power Button	1 x 2-pin terminal block
Display Interface	<ul style="list-style-type: none"> • 1 x HDMI 1.4 for console • 4 x DisplayPort
LAN	1 x RJ45 GbE LAN
Serial	1 x COM RS-232 port (RJ50 connector)
USB	4 x USB 3.0
Audio Jack	1 x Line-Out
Expansion	<ul style="list-style-type: none"> • 1 x M.2 B3042 with PCIe (x1) for storage / 4G LTE options • 1 x Mini-PCIe (full-size) for WiFi / BT / 4G LTE/ capture card options • 2 x 2.5" drive bay for SATA III SSD • 1 x SIM card slot
Environment	
Temperature	<ul style="list-style-type: none"> • Operating: 0 ~ 45 °C (32 ~ 113 °F) • Storage: -20 ~ 80 °C (-4 ~ 176 °F)
Relative Humidity	5 ~ 90% at 45 °C (non-condensing)
Vibration Protection	SSD: random operation 5 grms, 5~500 Hz

All specifications are subject to change without prior notice.

1.5 Product View

Front View



No.	Name	No.	Name
1	Power LED	4	USB 3.0 Port
2	Power Button	5	HDMI 1.4 Port
3	HDD LED		

Rear View

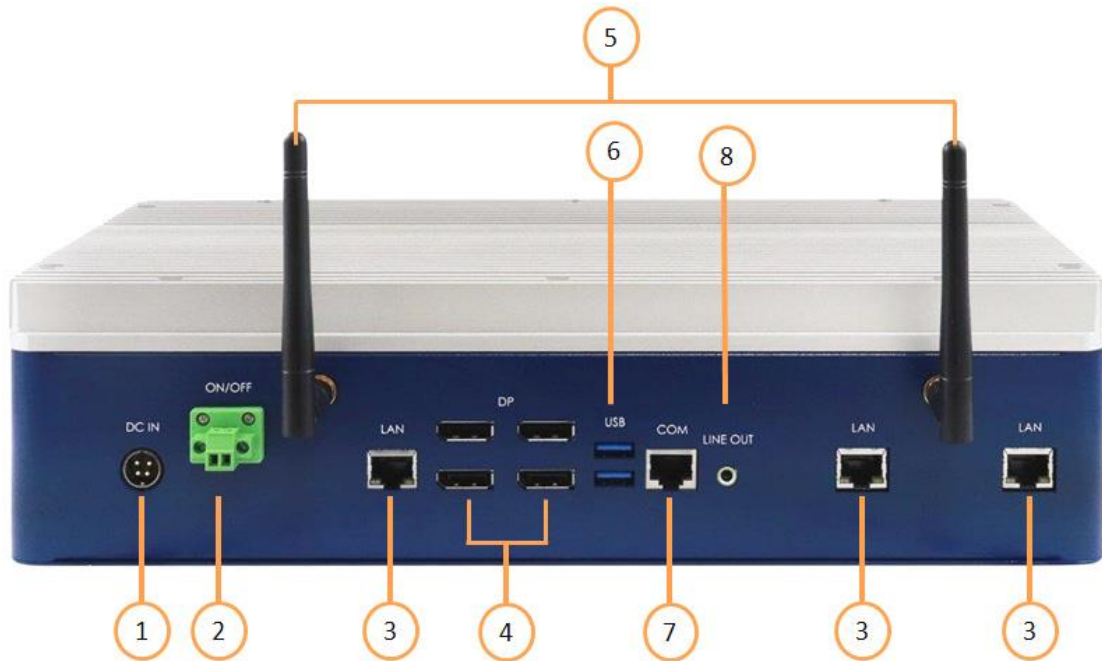

No.	Name	No.	Name
1	DC-In Power Input	5	Two Antennas
2	2-Pin Terminal Block (for external power button)	6	Two USB 3.0 Ports
3	Three LAN Ports	7	COM1 RS-232 Port (RJ50)
4	Four DP Ports	8	Audio Line-Out

Oblique View



1.6 Dimensions

Unit: mm

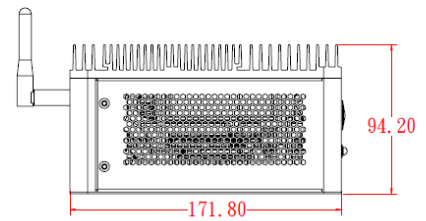
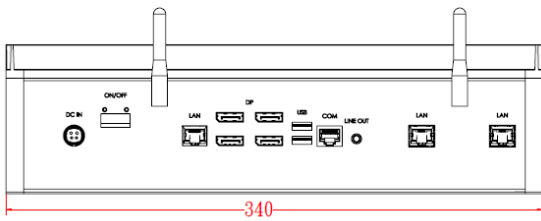
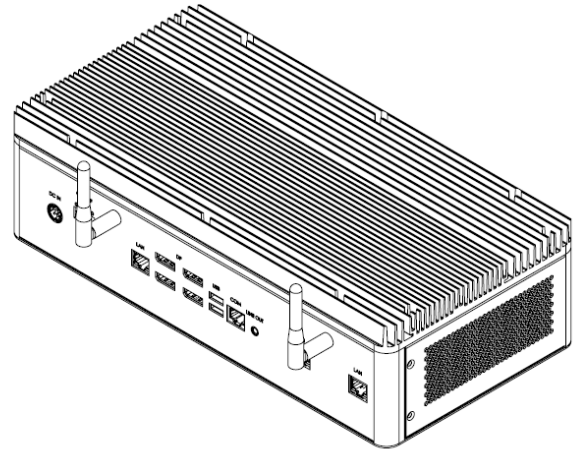
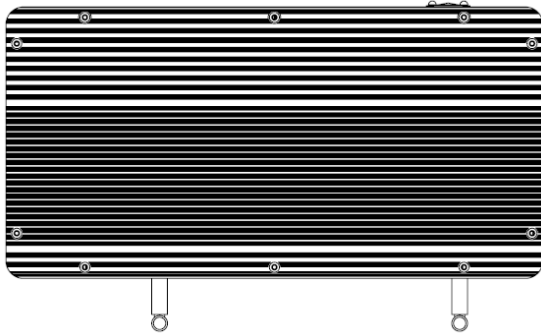

Chapter 2

Hardware Installation & Motherboard Information

The information provided in this chapter includes:

- Installation of memory, M.2 and mini PCIe card
- Information and locations of connectors

2.1 Installation / Replacement

Remove the 10 screws, as shown below, to remove the cover.

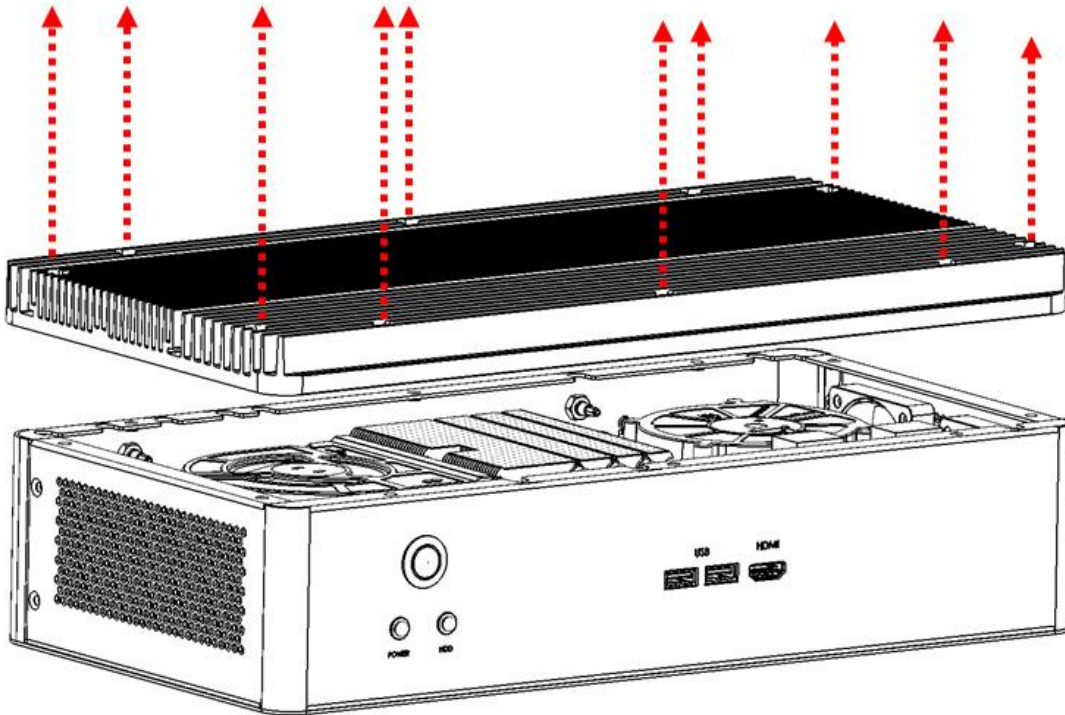

2.1.1 Memory

To install the modules, locate the memory slot on the motherboard and perform the following steps:

1. Press the ejector tab of the memory slot down and outwards with your fingertips.

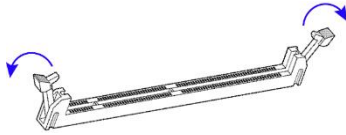

2. Hold the memory module and align the key of the module with that on the memory slot.
3. Gently push the module in an upright position until the ejector tabs of the memory slot close to hold the module in place when the module touches the bottom of the slot.

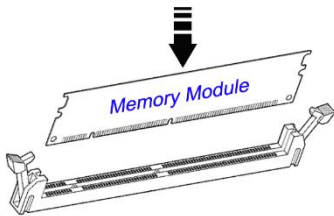

To remove the module, press the ejector tabs outwards with your fingertips to eject the module.

2.1.2 SSD

1. Turn the device upside down. Remove the screws, as shown, and lift up the plate.

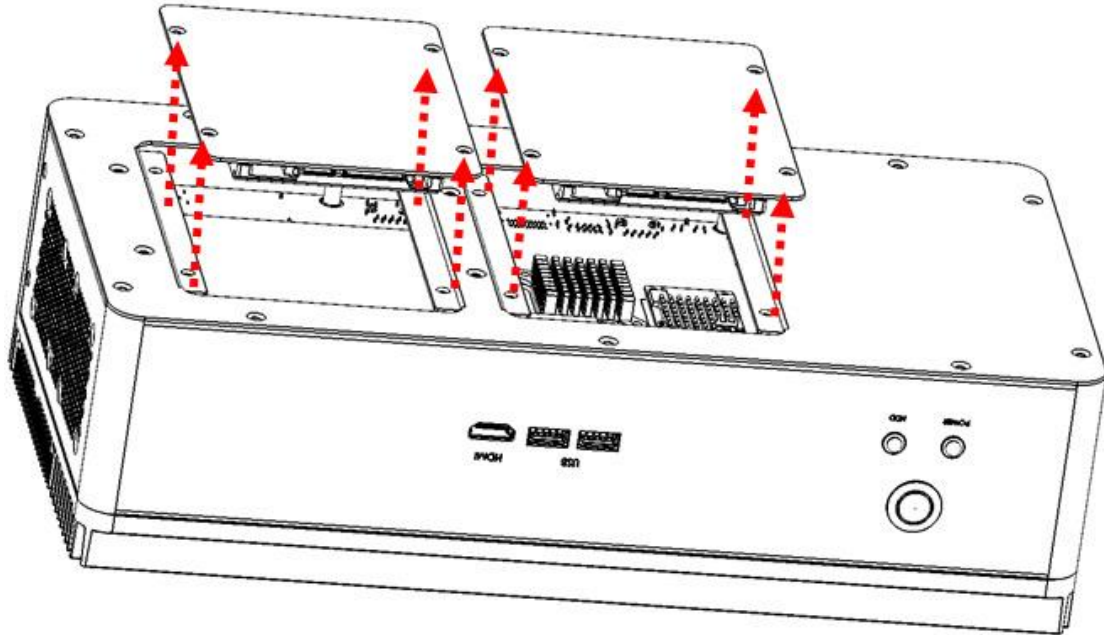

2. Remove the 4 screws below to release the SSD.



2.1.3 Mini-PCle & M.2 Cards

If you need to replace or install the mini PCIe or M.2 card, remove the following bracket after the SSD is removed.

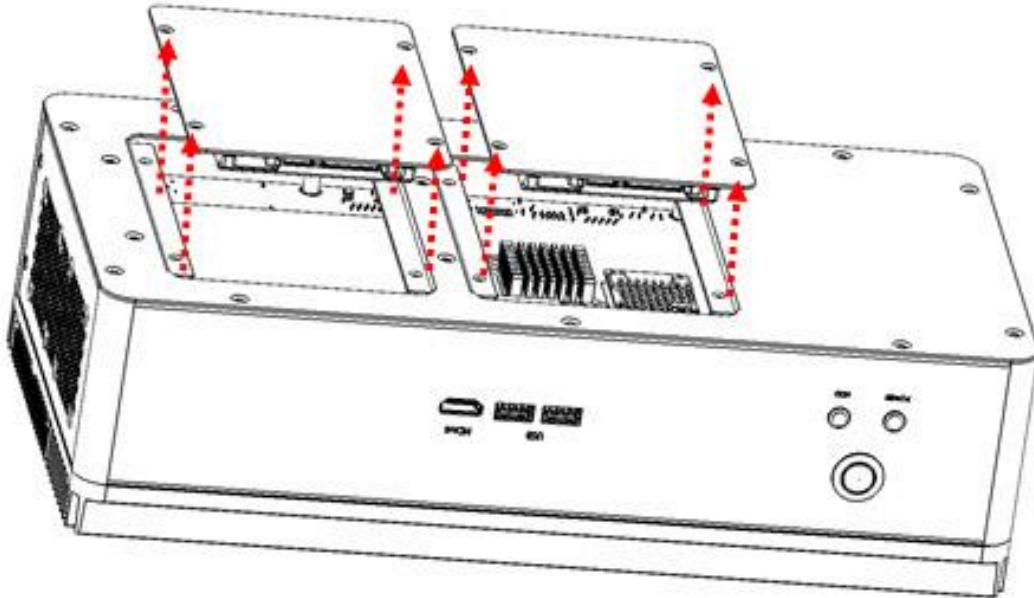

1. Locate the mini-PCle or M.2 slot inside the device.
2. Align the key of the mini-PCle card to the mini-PCle interface, and insert the card slantwise. (Insert the M.2 card in the same way.)

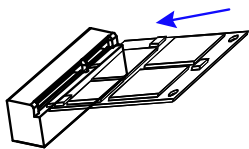

3. Push the mini-PCle card down and fix it with the an M2 screw. (Fix the M.2 network card with an M3 screw.)

Mini PCIe:

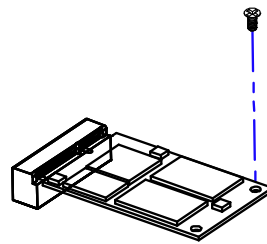
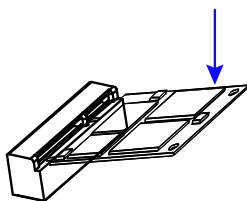

M.2:

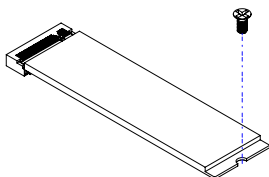

2.1.4 WiFi / 3G / 4G Antenna Installation

Thread the WiFi / 3G / 4G antenna extension cable through an antenna hole of the front I/O cover and fasten the antenna as shown below. Then apply adhesive to the edge of the hex nut behind the front I/O cover to prevent the extension cable from falling if the cable becomes loose.

1. Thread and fasten the hex nut and the washer. Then install the antenna.

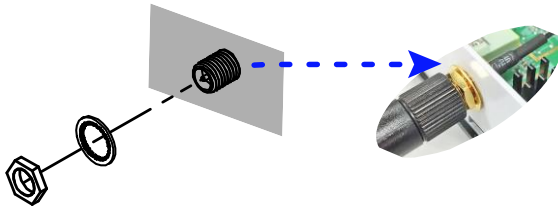

2. Apply adhesive around here.

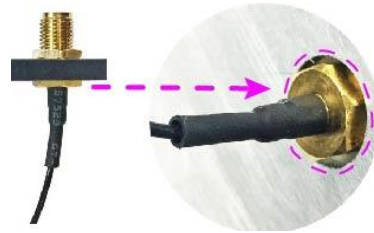

Info: The diameter of the nut is around 6.35 mm (0.25"-36UNC).

2.2 Pin Assignment for DC Power Input Connector



Pin	Signal Name	Pin	Signal Name
1	+19V	2	+19V
3	Ground	4	Ground

2.3 Pin Assignment for External Power Input Connector



Pin	Signal Name	Pin	Signal Name
1	Ground	2	PWR_SW

2.4 Pin Assignment for COM1 RS-232 Port



COM1 port is jumper-less and configurable in BIOS.

Pin	Signal Name	Pin	Signal Name
1	DSR, Data set ready	6	DCD, Data carrier detect
2	Ground	7	DTR, Data terminal ready
3	Ground	8	CTS, Clear to send
4	TX, Transmit	9	RTS, Request to send
5	RX, Receive	10	RI, Ring Indicator

2.5 Setting the Jumpers

Set up and configure the EC-7100 by using jumpers for various settings and features according to your needs and applications. Contact your supplier if you have doubts about the best configuration for your use.

2.5.1 How to Set Jumpers

Jumpers are short-length conductors consisting of several metal pins with a non-conductive base mounted on the circuit board. Jumper caps are used to have the functions and features enabled or disabled. If a jumper has 3 pins, you can connect either PIN1 to PIN2 or PIN2 to PIN3 by shorting.

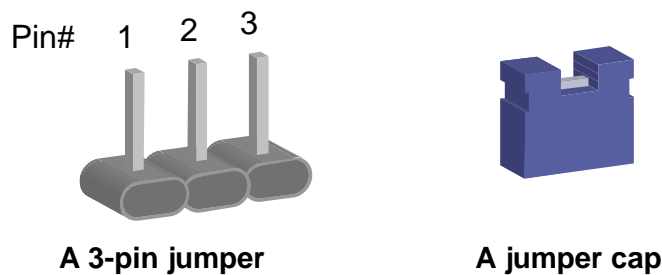

Refer to the illustration below to set jumpers.

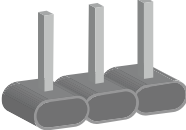
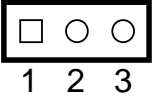
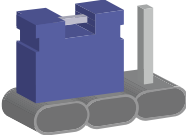
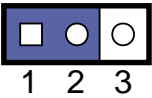
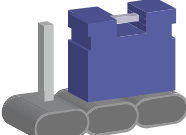
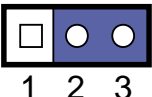
Pin closed	Oblique view	Schematic illustration
Open		
1-2		
2-3		

When two pins of a jumper are encased in a jumper cap, this jumper is **closed**, i.e. turned **On**.

When a jumper cap is removed from two jumper pins, this jumper is **open**, i.e. turned **Off**.

2.6 Jumper & Connector Locations on Motherboard

Motherboard: MBD614

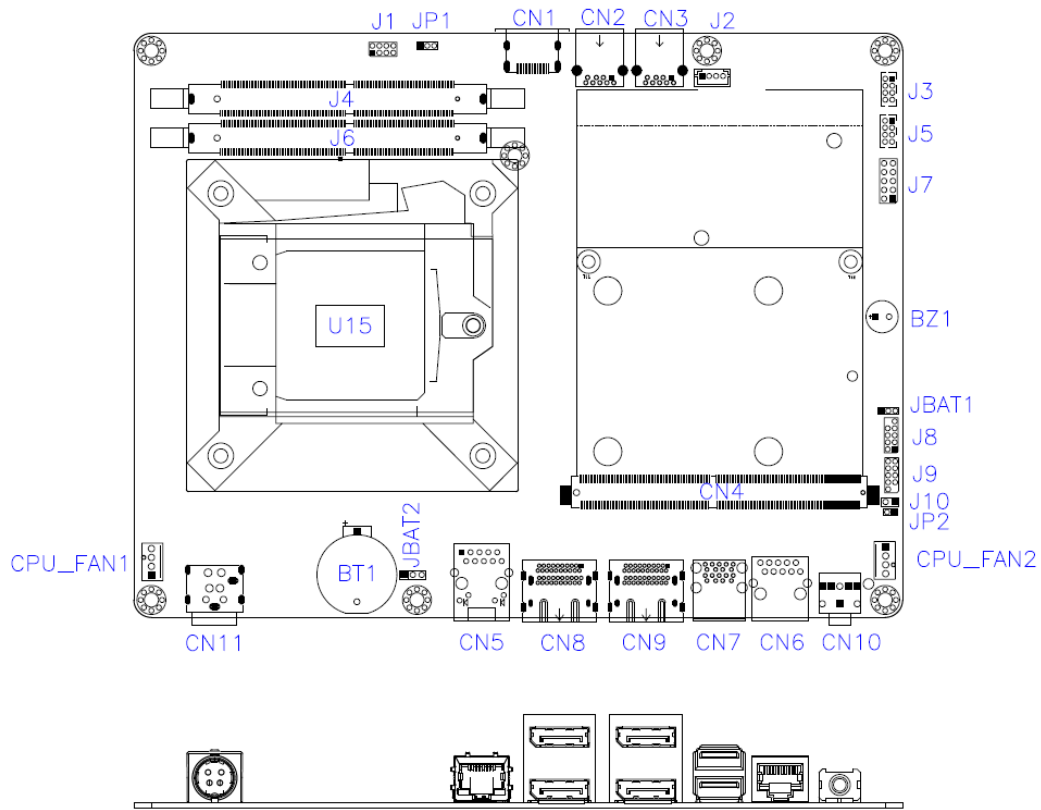

MBD614 – top and I/O

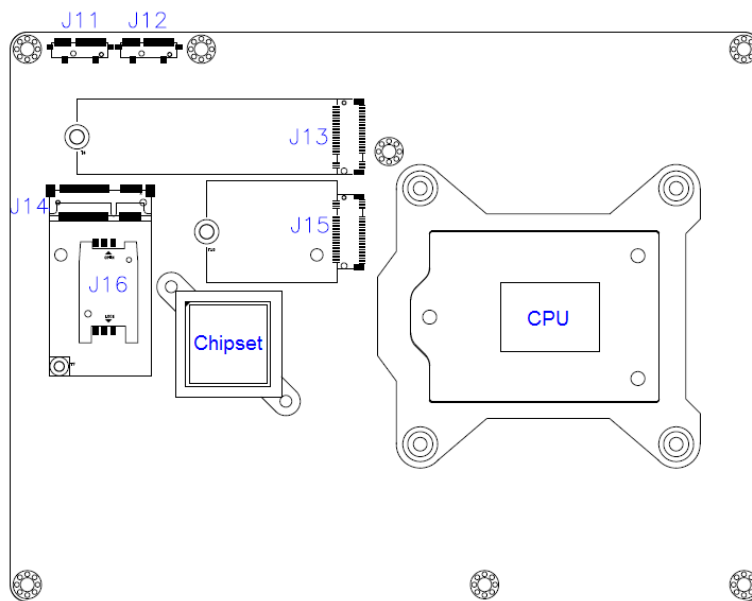

MBD614 - bottom

2.7 Jumpers Quick Reference

Function	Connector Name	Page
Clearing CMOS Data	JBAT2	18
Clearing ME Register	JBAT1	18

2.7.1 Clearing CMOS Data (JBAT2)

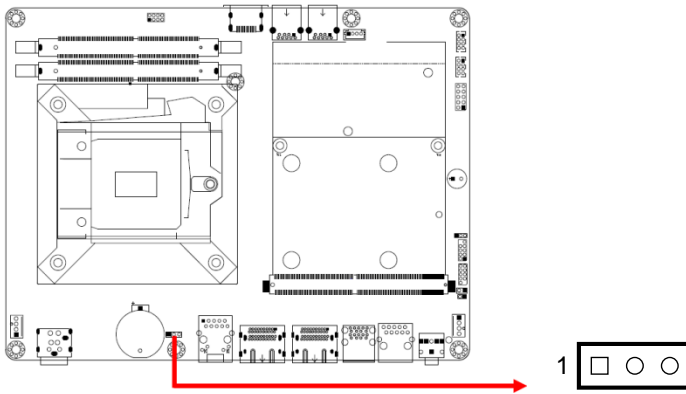

Function	Pin closed	Illustration
Normal (default)	1-2	1
Clear CMOS	2-3	1

2.7.2 Clearing ME Register (JBAT1)

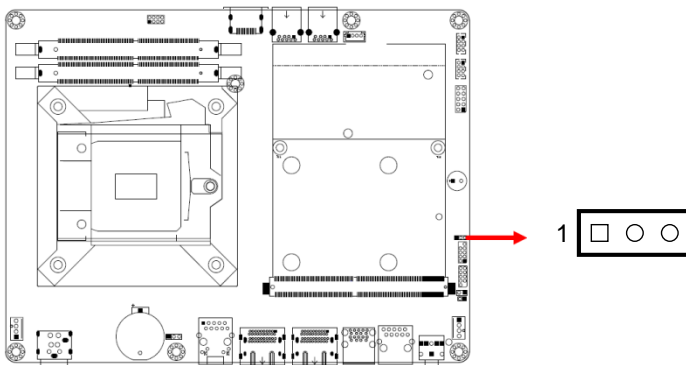

Function	Pin closed	Illustration
Normal (default)	1-2	1
Clear ME	2-3	1

2.8 Connectors Quick Reference

Function	Connector Name	Page
Front Panel Setting Connector	J1	20
USB 2.0 Connector	J3, J5	20
CPU Fan Power Connector	CPU_FAN1, CPU_FAN2	21
Digital I/O Connector	J7	21
External Power Bottom Connector	J10	22
COM1 RS-232 Port	CN6 (RJ50 connector)	22
SATA Connector	J11, J12	23
MXM Connector	CN4	23
DC Power Input ^[1]	CN11	--
GbE LAN Port	CN5	--
USB 3.0 Port	CN2, CN3, CN7	--
DisplayPort	CN8, CN9	--
Audio Line-Out	CN10	--
HDMI 1.4 Port	CN1	--
M.2 M2280 Slot with SATA & PCIe (x4)	J13	--
M.2 B3042 Slot with USB 2.0	J15	--
Mini-PCIe Slot	J14	--
SIM Card Socket	J16	--
Factory Use Only	J2, J8, J9	--

[1]: Refer to 2.2 *Pin Assignment for DC Power Input Connector*.

2.8.1 Front Panel Setting Connector (J1)

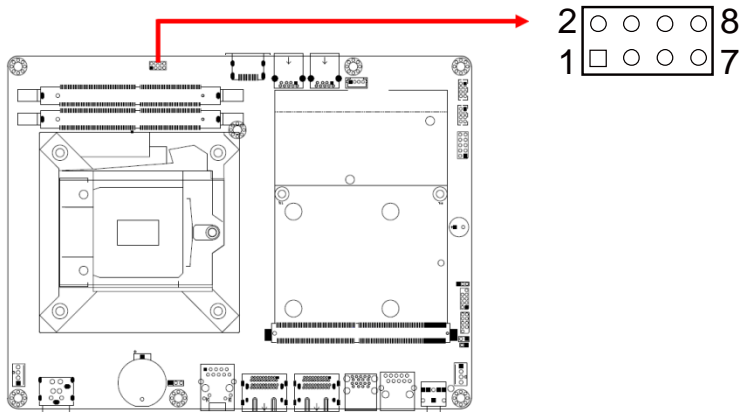

Pin	Signal Name	Pin	Signal Name
1	Power BTN-	2	Power BTN+
3	Powe LED+	4	Powe LED-
5	HDD LED+	6	HDDLED-
7	Reset BTN-	8	Reset BTN+

2.8.2 USB 2.0 Connector (J3, J5)

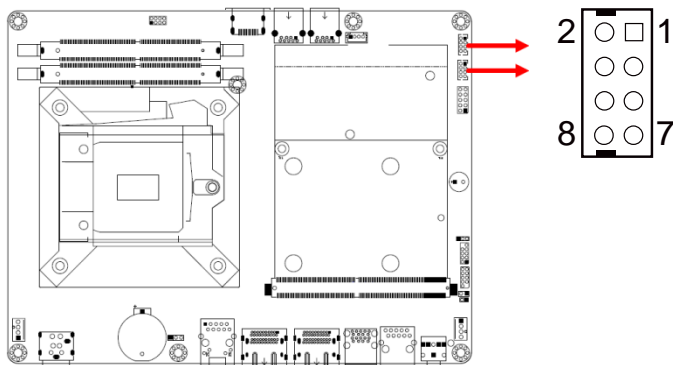

Pin	Signal Name	Pin	Signal Name
1	+5V	2	+5V
3	Data-	4	Data-
5	Data+	6	Data+
7	Ground	8	Ground

2.8.3 CPU Fan Power Connector (CPU_FAN1, CPU_FAN2)

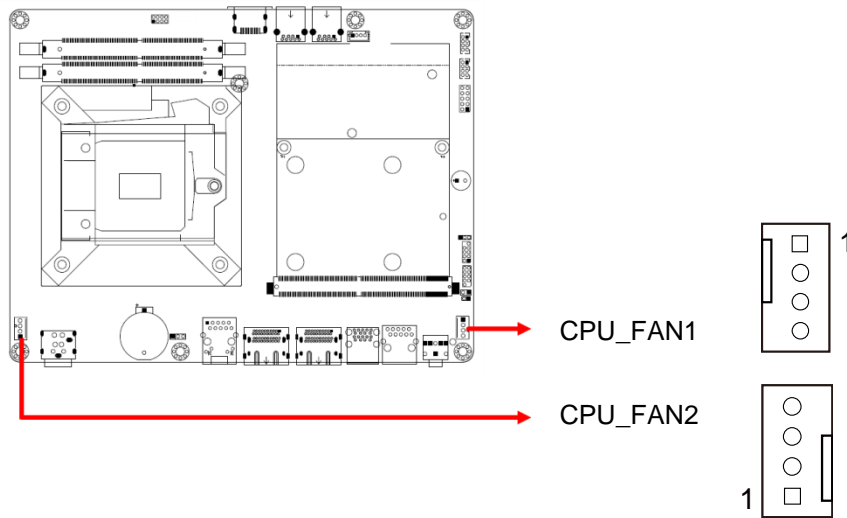

Pin	Signal Name	Pin	Signal Name
1	Ground	3	Rotation detection
2	+12V	4	Control

2.8.4 Digital I/O Connector (J7)

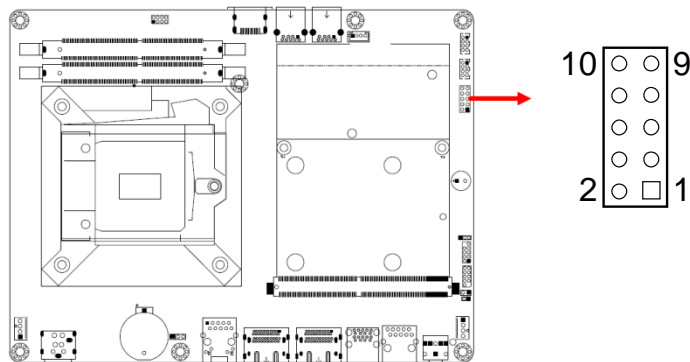

Pin	Signal Name	Pin	Signal Name
1	Ground	2	+5V
3	Out3	4	Out1
5	Out2	6	Out0
7	IN3	8	IN1
9	IN2	10	IN0

2.8.5 External Power Button Connector (J10)

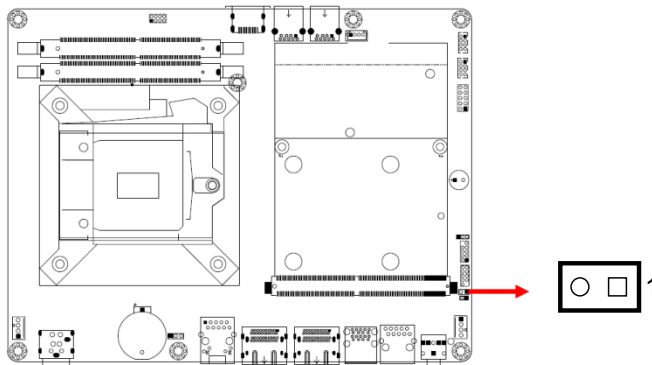

Pin	Signal Name	Pin	Signal Name
1	Power BTN+	2	Power BTN-

2.8.6 COM1 RS-232 Port (CN6)

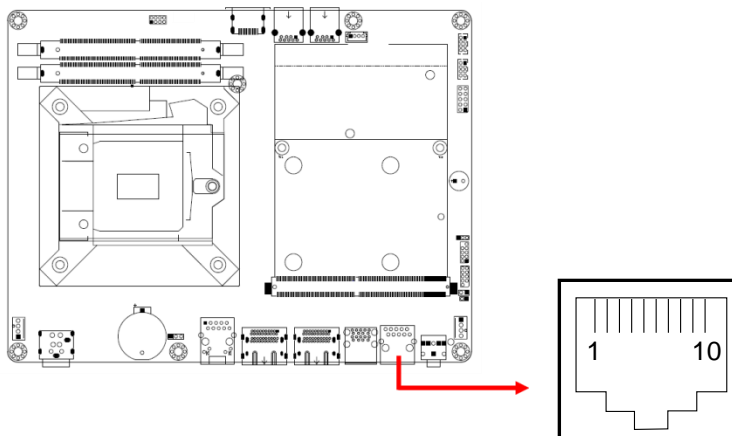

COM1 port is jumper-less and configurable in BIOS.

Pin	Signal Name	Pin	Signal Name
1	DSR, Data set ready	6	DCD, Data carrier detect
2	Ground	7	DTR, Data terminal ready
3	Ground	8	CTS, Clear to send
4	TX, Transmit	9	RTS, Request to send
5	RX, Receive	10	RI, Ring Indicator

2.8.7 SATA Connector (J11, J12)

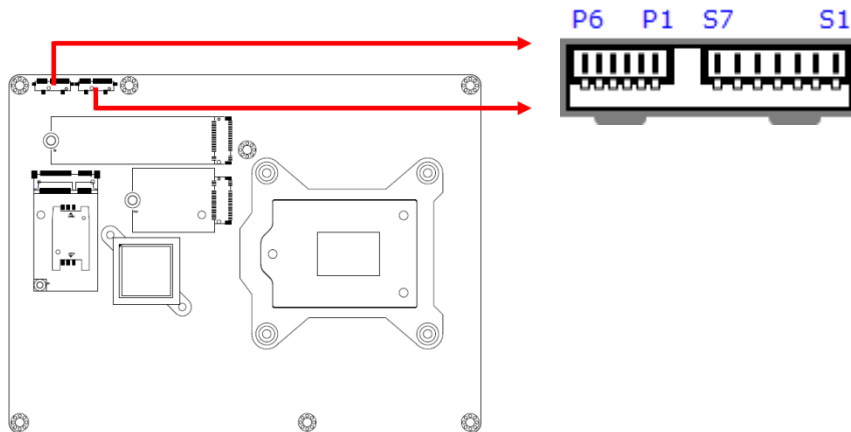

Pin	Signal Name	Pin	Signal Name
S1	Ground	P1	NC1
S2	A+	P2	NC2
S3	A-	P3	Ground
S4	Ground	P4	Ground
S5	B-	P5	+5V
S6	B+	P6	+5V
S7	Ground		

2.8.8 MXM Connector (CN4)

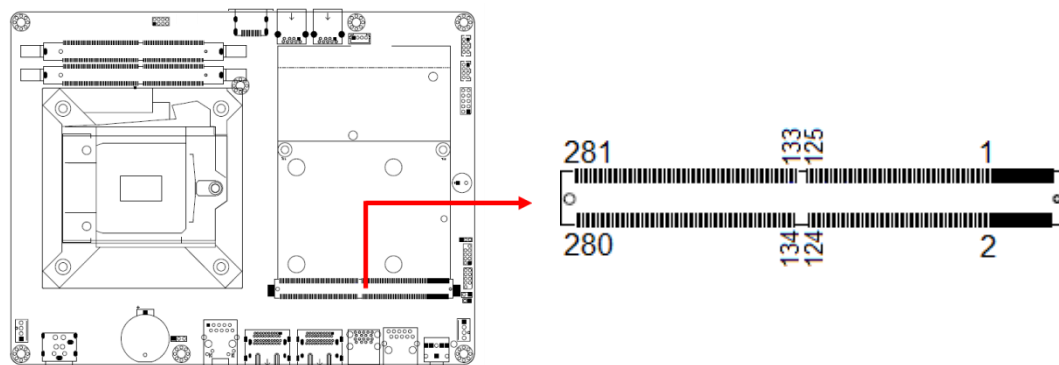

Pin	Signal Name	Pin	Signal Name	Pin	Signal Name	Pin	Signal Name
E1	PWR_SRC	E2	PWR_SRC	141	PEX_RX1#	142	PEX_TX1#
E3	Ground	E4	Ground	143	PEX_RX1	144	PEX_TX1
1	5V	2	PRSENT_R#	145	Ground	146	Ground

Pin	Signal Name	Pin	Signal Name	Pin	Signal Name	Pin	Signal Name
3	5V	4	WAKE# (N/C)	147	PEX_RX0#	148	PEX_TX0#
5	5V	6	PWR_GOOD	149	PEX_RX0	150	PEX_TX0
7	5V	8	PWR_EN	151	Ground	152	Ground
9	5V	10	27MHZ_REF (N/C)	153	PEX_REFCLK#	154	PEX_CLK_REQ#
11	Ground	12	Ground	155	PEX_REFCLK	156	PEX_RST#
13	Ground	14	DP_F_HPD	157	Ground	158	VGA_DDC_DAT (N/C)
15	Ground	16	JTAG_TESTEN (N/C)	159	JTAG_TDO (N/C)	160	VGA_DDC_CLK (N/C)
17	Ground	18	PWR_LEVEL	161	JTAG_TDI (N/C)	162	VGA_VSYNC (N/C)
19	PEX_STD_SW#	20	TH_OVERT#	163	JTAG_TCLK (N/C)	164	VGA_HSYNC (N/C)
21	VGA_DISABLE#	22	TH_ALERT#	165	JTAG_TMS (N/C)	166	Ground
23	PNL_PWR_EN	24	TH_PWN	167	JTAG_TRST# (N/C)	168	VGA_RED (N/C)
25	PNL_BL_EN	26	GPIO0	169	DP_F_L3#	170	VGA_GREEN (N/C)
27	PNL_BL_PWN	28	GPIO1	171	DP_F_L3	172	VGA_BLUE (N/C)
29	HDMI_CEC (N/C)	30	GPIO2	173	Ground	174	Ground
31	DP_E_HPD	32	SMB_DAT	175	DP_F_AUX#	176	DP_E_L3#
33	I2C_DAT	34	SMB_CLK	177	DP_F_AUX	178	DP_E_L3
35	I2C_CLK	36	Ground	179	Ground	180	Ground
37	Ground	38	OEM0 (N/C)	181	DP_F_L0#	182	DP_E_AUX#
39	OEM1 (N/C)	40	OEM2 (N/C)	183	DP_F_L0	184	DP_E_AUX
41	OEM3 (N/C)	42	OEM4	185	Ground	186	Ground
43	OEM5	44	OEM6	187	DP_F_L1#	188	DP_E_L0#
45	OEM7	46	Ground	189	DP_F_L1	190	DP_E_L0
47	Ground	48	PEX_TX15#	191	Ground	192	Ground
49	PEX_RX15#	50	PEX_TX15	193	DP_F_L2#	194	DP_E_L1#
51	PEX_RX15	52	Ground	195	DP_F_L2	196	DP_E_L1
53	Ground	54	PEX_TX14#	197	Ground	198	Ground
55	PEX_RX14#	56	PEX_TX14	199	DP_C_L0#	200	DP_E_L2#
57	PEX_RX14	58	Ground	201	DP_C_L0	202	DP_E_L2
59	Ground	60	PEX_TX13#	203	Ground	204	Ground
61	PEX_RX13#	62	PEX_TX13	205	DP_C_L1#	206	DP_D_L0#
63	PEX_RX13	64	Ground	207	DP_C_L1	208	DP_D_L0
65	Ground	66	PEX_TX12#	209	Ground	210	Ground
67	PEX_RX12#	68	PEX_TX12	211	DP_C_L2#	212	DP_D_L1#
69	PEX_RX12	70	Ground	213	DP_C_L2	214	DP_D_L1

Pin	Signal Name	Pin	Signal Name	Pin	Signal Name	Pin	Signal Name
71	Ground	72	PEX_TX11#	215	Ground	216	Ground
73	PEX_RX11#	74	PEX_TX11	217	DP_C_L3#	218	DP_D_L2#
75	PEX_RX11	76	Ground	219	DP_C_L3	220	DP_D_L2
77	Ground	78	PEX_TX10#	221	Ground	222	Ground
79	PEX_RX10#	80	PEX_TX10	223	DP_C_AUX#	224	DP_D_L3#
81	PEX_RX10	82	Ground	225	DP_C_AUX	226	DP_D_L3
83	Ground	84	PEX_TX9#	227	RSVD (N/C)	228	Ground
85	PEX_RX9#	86	PEX_TX9	229	RSVD (N/C)	230	DP_D_AUX#
87	PEX_RX9	88	Ground	231	RSVD (N/C)	232	DP_D_AUX
89	Ground	90	PEX_TX8#	233	RSVD (N/C)	234	DP_C_HPDP
91	PEX_RX8#	92	PEX_TX8	235	RSVD (N/C)	236	DP_D_HPDP
93	PEX_RX8	94	Ground	237	RSVD (N/C)	238	RSVD (N/C)
95	Ground	96	PEX_TX7#	239	RSVD	240	3V3
97	PEX_RX7#	98	PEX_TX7	241	RSVD (N/C)	242	3V3
99	PEX_RX7	100	Ground	243	RSVD (N/C)	244	Ground
101	Ground	102	PEX_TX6#	245	RSVD (N/C)	246	DP_B_L0#
103	PEX_RX6#	104	PEX_TX6	247	RSVD (N/C)	248	DP_B_L0
105	PEX_RX6	106	Ground	249	RSVD (N/C)	250	Ground
107	Ground	108	PEX_TX5#	251	Ground	252	DP_B_L1#
109	PEX_RX5#	110	PEX_TX5	253	DP_A_L0#	254	DP_B_L1
111	PEX_RX5	112	Ground	255	DP_A_L0	256	Ground
113	Ground	114	PEX_TX4#	257	Ground	258	DP_B_L2#
115	PEX_RX4#	116	PEX_TX4	259	DP_A_L1#	260	DP_B_L2
117	PEX_RX4	118	Ground	261	DP_A_L1	262	Ground
119	Ground	120	PEX_TX3#	263	Ground	264	DP_B_L3#
121	PEX_RX3#	122	PEX_TX3	265	DP_A_L2#	266	DP_B_L3
123	PEX_RX3	124	Ground	267	DP_A_L2	268	Ground
125	Ground	126	KEY	269	Ground	270	DP_B_AUX#
127	KEY	128	KEY	271	DP_A_L3#	272	DP_B_AUX
129	KEY	130	KEY	273	DP_A_L3	274	DP_B_HPDP
131	KEY	132	KEY	275	Ground	276	DP_A_HPDP
133	Ground	134	Ground	277	DP_A_AUX#	278	3V3
135	PEX_RX2#	136	PEX_TX2#	279	DP_A_AUX	280	3V3
137	PEX_RX2	138	PEX_TX2	281	PRSNT_L#		
139	Ground	140	Ground				

Chapter 3

Driver Installation

The information provided in this chapter includes:

- Intel® Chipset Software Installation Utility
- HD Audio Driver Installation
- LAN Driver Installation
- Intel® Management Engine Component Drivers Installation

3.1 Introduction

This section describes the installation procedures for software drivers. The software drivers are available on IBASE website www.ibase.com.tw. Register as a member of our website to download all the necessary drivers and extract for installation.

Note: After installing your Windows operating system, you must install the Intel® Chipset Software Installation Utility first before proceeding with the drivers installation.

3.2 Intel® Chipset Software Installation Utility

The Intel® Chipset drivers should be installed first before the software drivers to install INF files for Plug & Play function for the chipset components. Follow the instructions below to complete the installation.

1. Run the **Setup.exe** file.
2. When the *Welcome* screen to the Intel® Chipset Device Software appears, click **Next** to continue.

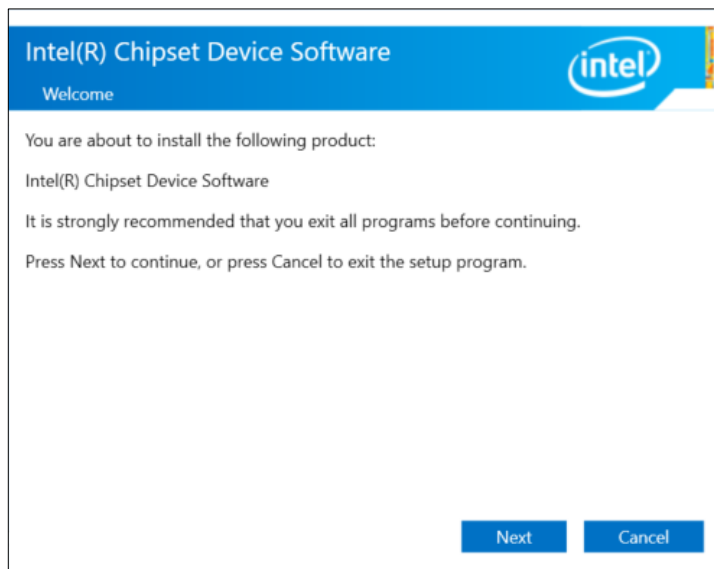

3. Accept the license agreement and proceed with the installation process.
4. When the driver is completely installed, restart the computer for changes to take effect.

3.3 HD Audio Driver Installation

1. Run the **Setup.exe** file.
2. On the *Welcome* screen of the InstallShield Wizard, click **Next**.

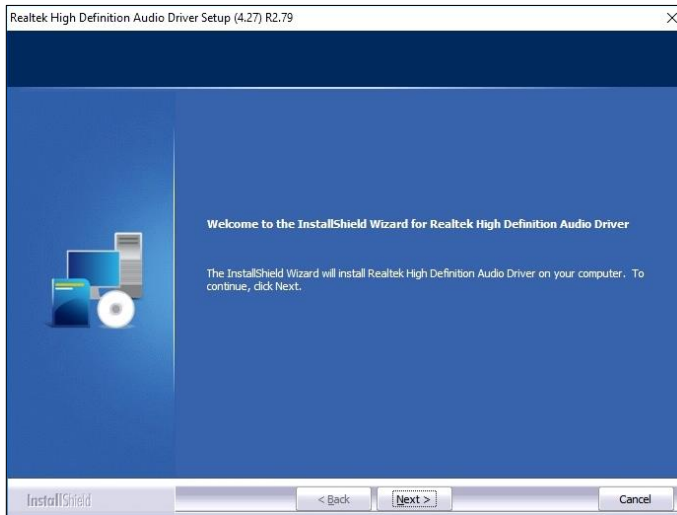

3. When the driver is completely installed, restart the computer for changes to take effect.

3.4 LAN Driver Installation

1. Run the **Setup.exe** file.
2. On the *Welcome* screen of the InstallShield Wizard, click **Next**.

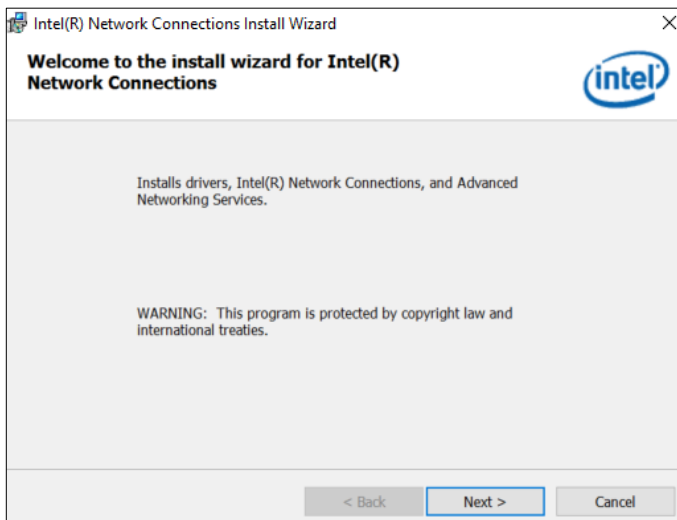

3. Accept the license agreement and click **Next** to continue.
4. On the *Setup Options* screen, tick the checkbox to select the desired driver(s) and click **Next** for installation.

When the driver is completely installed, restart the computer for changes to take effect.

3.5 Intel® Management Engine Components Drivers Installation

1. Run the **Setup.exe** file.
2. When the *Welcome* screen appears, click **Next**.

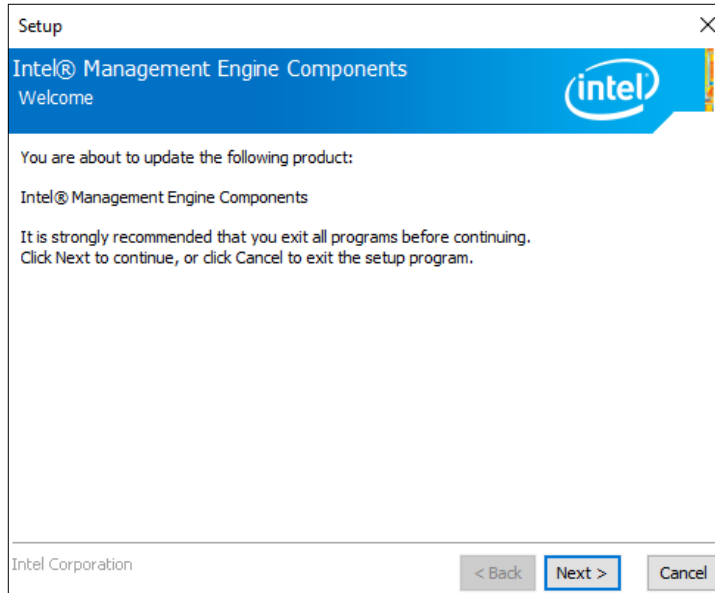

3. Accept the license agreement and click **Next** for installation.
4. The driver has been completely installed. Restart the computer for changes to take effect.

3.6 NVIDIA® GeForce® MXM Driver Installation

1. Download the driver from NVIDIA's website or IBASE's website.
2. Accept the software license agreement and start installation.
3. Click **Close** to finish the installation.

Chapter 4

BIOS Setup

This chapter describes the different settings available in the AMI BIOS that comes with the board. The topics covered in this chapter are as follows:

- Main Settings
- Advanced Settings
- Chipset Settings
- Security Settings
- Boot Settings
- Save & Exit

4.1 Introduction

The BIOS (Basic Input/Output System) installed in the ROM of your computer system supports Intel® processors. The BIOS provides critical low-level support for standard devices such as disk drives, serial ports and parallel ports. It also provides password protection as well as special support for detailed fine-tuning of the chipset controlling the entire system.

4.2 BIOS Setup

The BIOS provides a Setup utility program for specifying the system configurations and settings. The BIOS ROM of the system stores the Setup utility. When you turn on the computer, the BIOS is immediately activated. Press the key immediately allows you to enter the Setup utility. If you are a little bit late pressing the key, POST (Power On Self Test) will continue with its test routines, thus preventing you from invoking the Setup.

If you still need to enter Setup, restart the system by pressing the "Reset" button or simultaneously pressing the <Ctrl>, <Alt> and <Delete> keys. You can also restart by turning the system Off and back On again.

The following message will appear on the screen:

```
Press <DEL> to Enter Setup
```

In general, press the arrow keys to highlight items, <Enter> to select, the <PgUp> and <PgDn> keys to change entries, <F1> for help, and <Esc> to quit.

When you enter the BIOS Setup utility, the *Main Menu* screen will appear on the screen. The Main Menu allows you to select from various setup functions and exit choices.

Warning: It is strongly recommended that you avoid making any changes to the chipset defaults.

These defaults have been carefully chosen by both AMI and your system manufacturer to provide the absolute maximum performance and reliability. Changing the defaults could make the system unstable and crash in some cases.

4.3 Main Settings

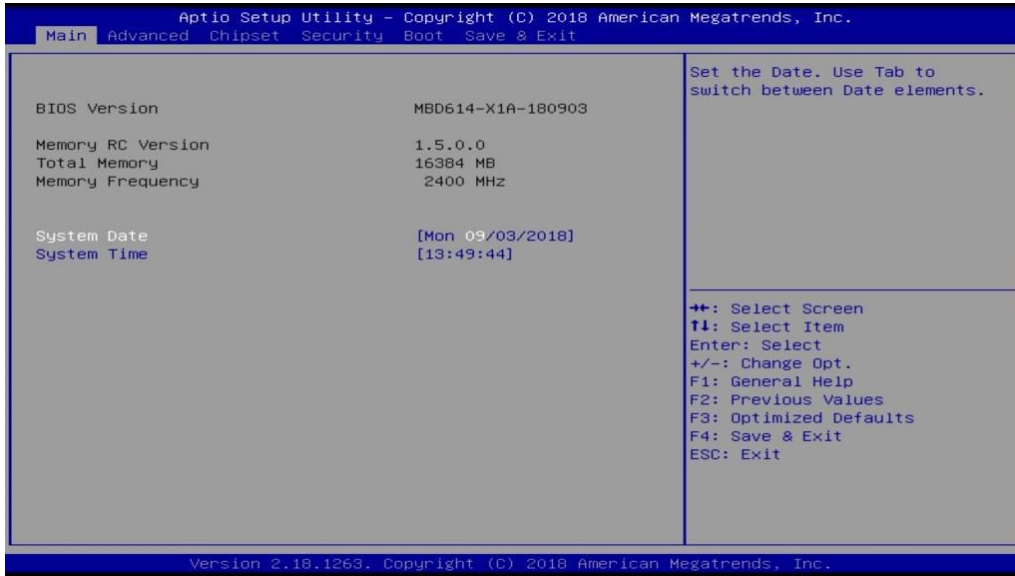

BIOS Setting	Description
System Date	Sets the date. Use the <Tab> key to switch between the data elements.
System Time	Set the time. Use the <Tab> key to switch between the data elements.

4.4 Advanced Settings

This section allows you to configure, improve your system and allows you to set up some system features according to your preference.

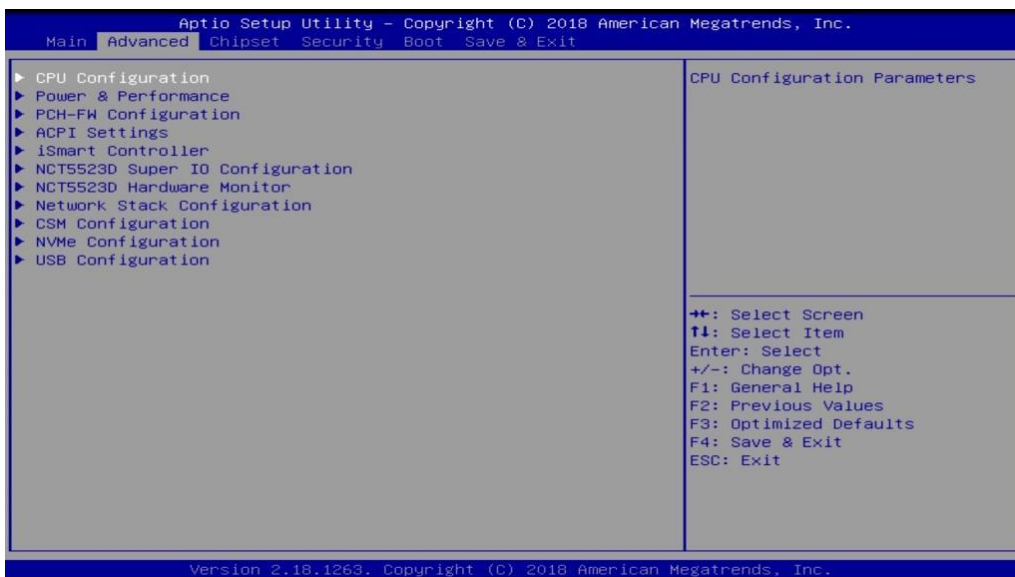

4.4.1 CPU Configuration

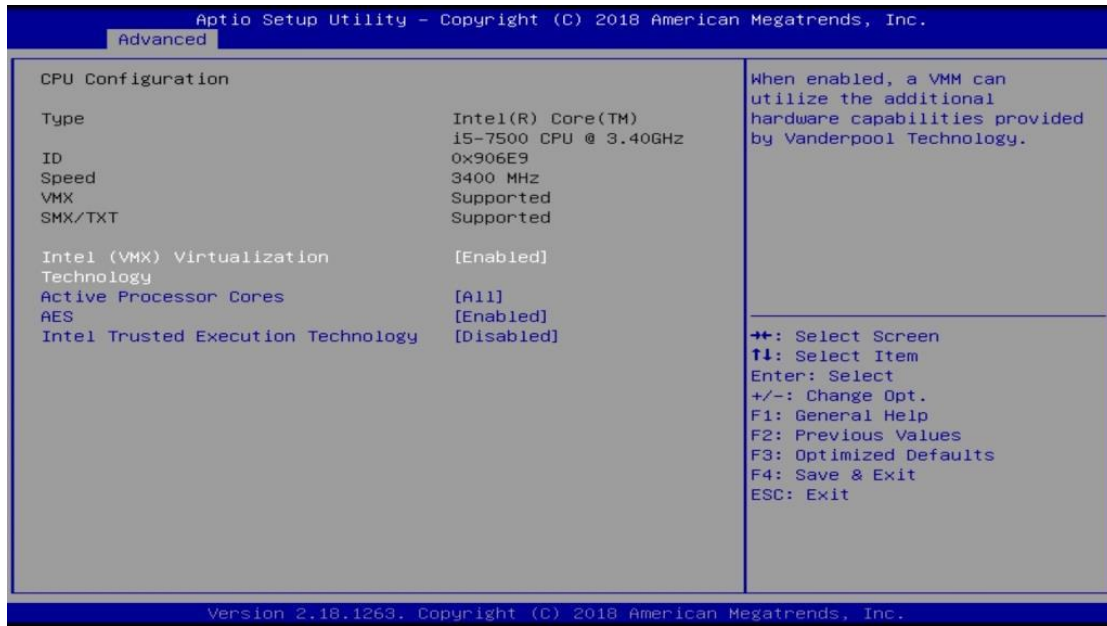

BIOS Setting	Description
Intel (VMX) Virtualization Technology	When enabled, a VMM can utilize the additional hardware capabilities provided by Vanderpool Technology.
Active Processor Cores	Number of cores to enable in each processor package.
Intel Trusted Execution Technology	Enables / Disables utilization of additional hardware capabilities provided by Intel(R) Trusted Execution Technology. Changes require a full power cycle to take effect.

4.4.2 Power & Performance

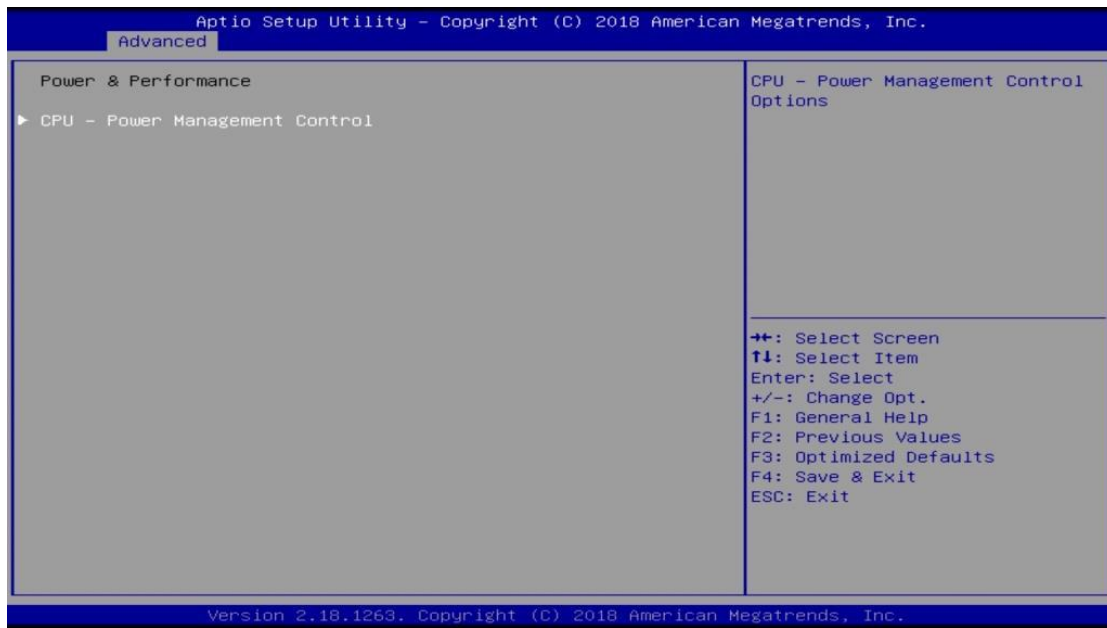

BIOS Setting	Description
CPU – Power Management Control	CPU power management control options.

4.4.3 PCH-FW Configuration

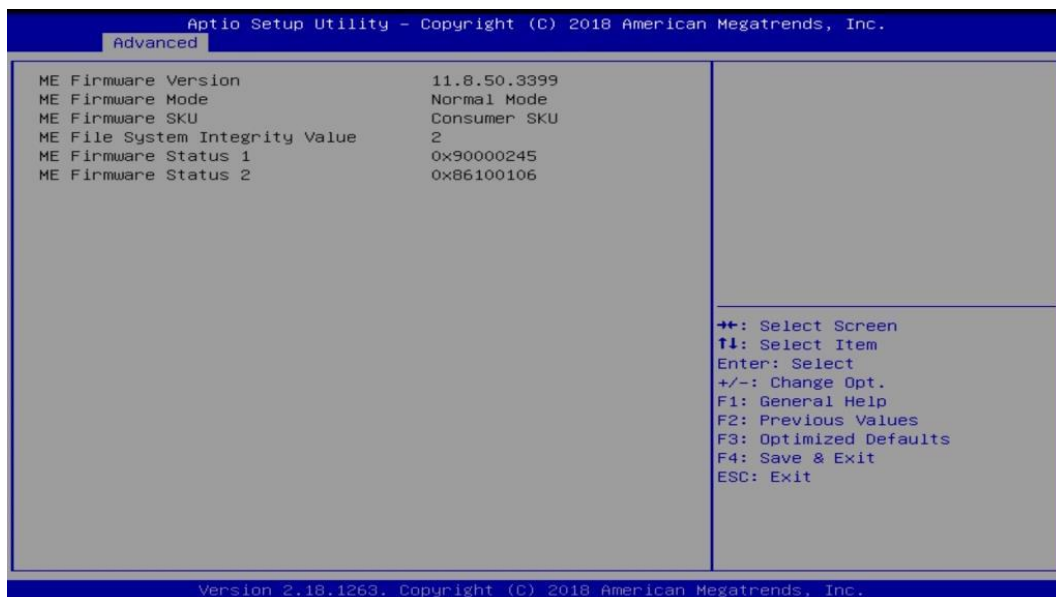

4.4.4 ACPI Settings

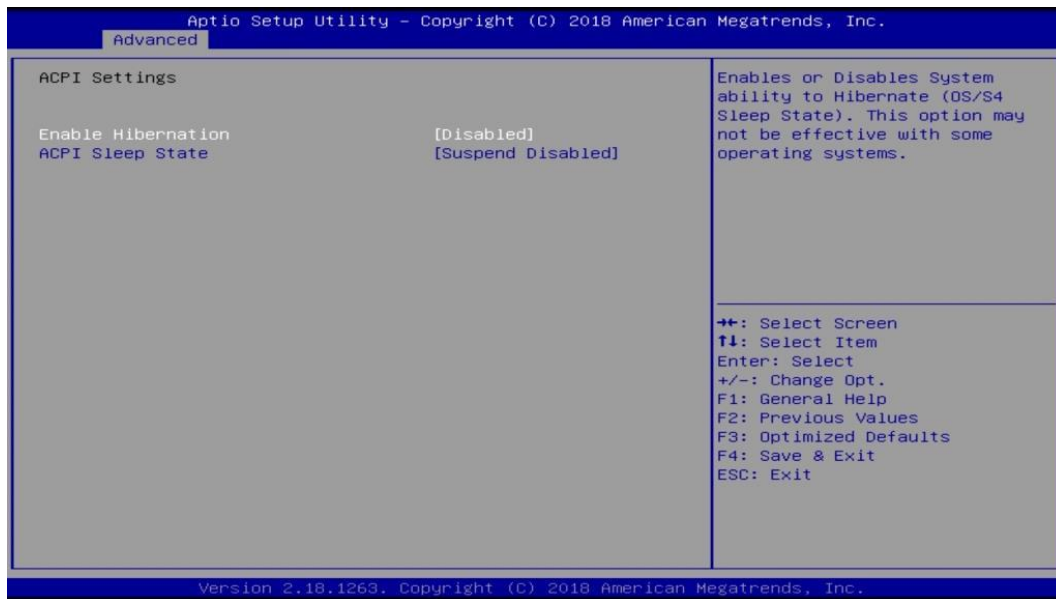

BIOS Setting	Description
Enable Hibernation	Enables / Disables system ability to hibernate (OS/S4 Sleep State). This option may not be effective with some operating systems.
ACPI Sleep State	Selects the highest ACPI sleep state the system will enter when the SUSPEND button is pressed.

4.4.5 iSmart Controller

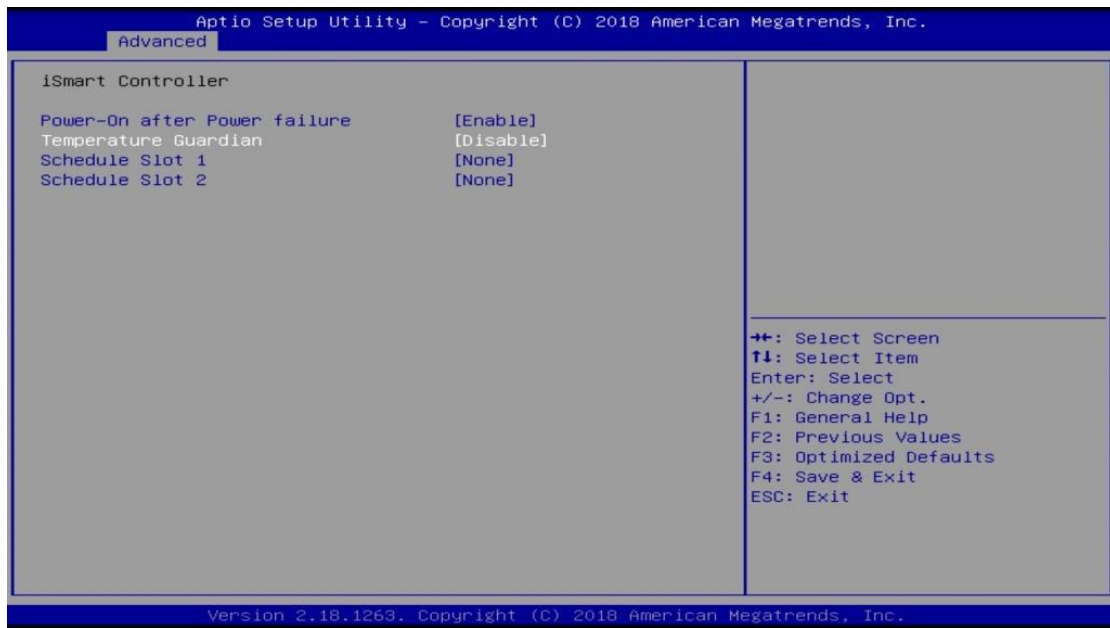

BIOS Setting	Description
Power-On after Power failure	Enables / Disables the system to be turned on automatically after a power failure.
Schedule Slot 1 / 2	<p>Sets up the hour / minute for system powe-on.</p> <p>Important: If you would like to set up a schedule between adjacent days, configure two schedule slots.</p> <p>For example, if setting up a schedule from Wednesday 5 p.m. to Thursday 2 a.m., configure two schedule slots. But if setting up a schedule from 3 p.m to 5 p.m. on Wednesday, configure only a schedule slot.</p>

4.4.6 NCT5523D Super IO Configuration

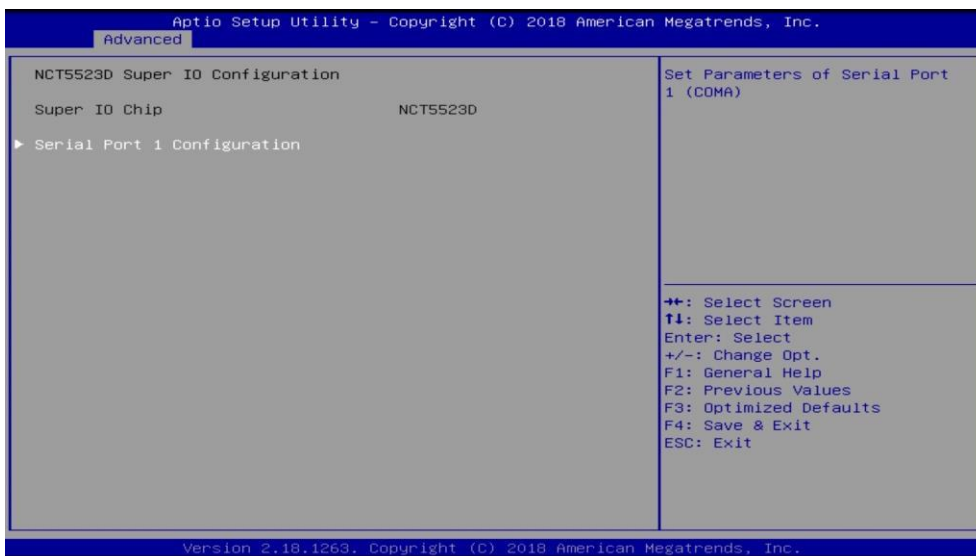

BIOS Setting	Description
Serial Port 1 Configuration	Sets parameters of Serial Port 1 (COMA). Enables / Disables the serial port and select an optimal setting for the Super IO device.

4.4.7 NCT5523D Hardware Monitor

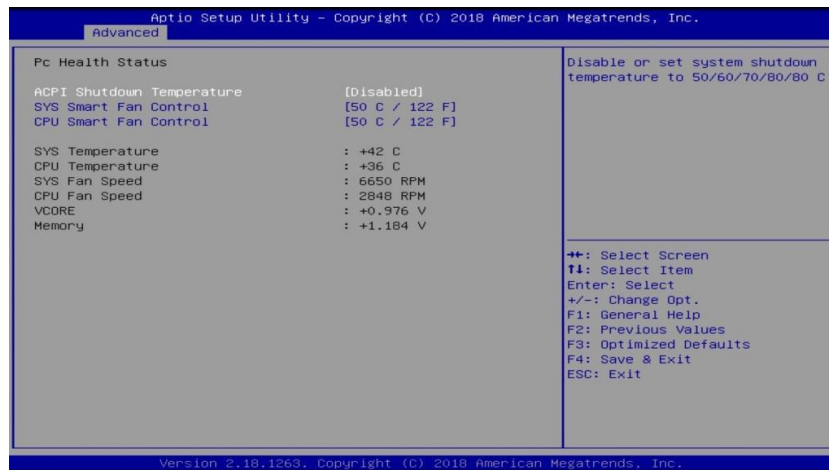

BIOS Setting	Description
ACPI Shutdown Temperature	Disables or sets system shutdown temperature to 50°C, 60°C, 70°C or 80°C.
System Smart Fan Control	Disable or set fan control for CPU_FAN2 at 50°C, 60°C, 70°C or 80°C.
CPU Smart Fan Control	Disable or set fan control for CPU_FAN1 at 50°C, 60°C, 70°C or 80°C.
Temperatures / Voltages	These fields are the parameters of the hardware monitoring function feature of the motherboard. The values are read-only values as monitored by the system and show the PC health status.

4.4.8 Network Stack Configuration



BIOS Setting	Description
Network Stack	Enables / Disables UEFI Network Stack.

4.4.9 CSM Configuration

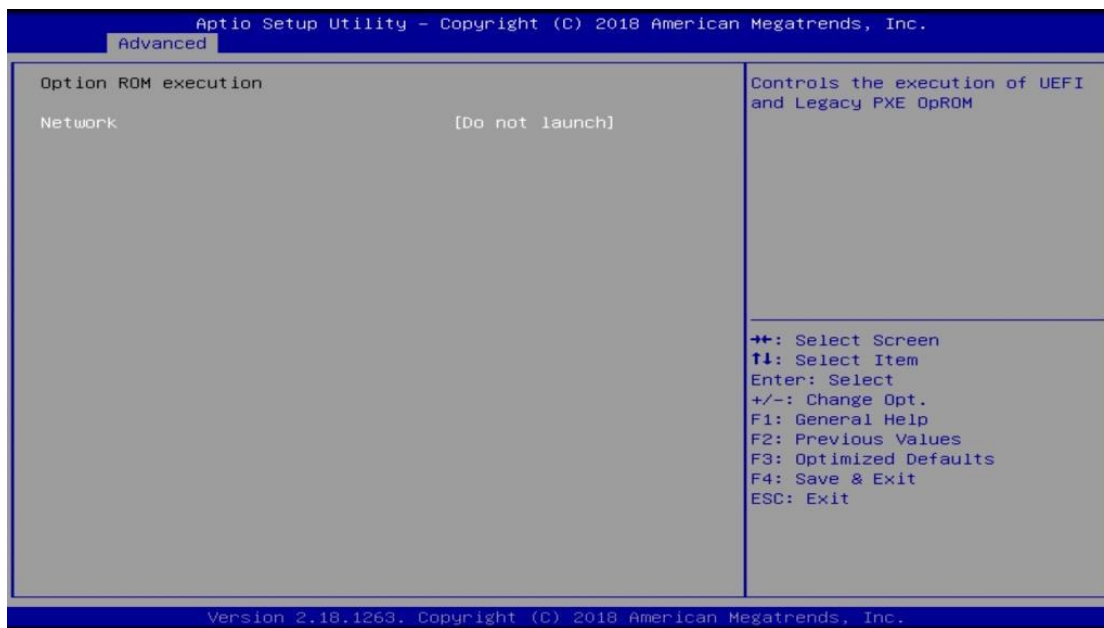

BIOS Setting	Description
Network	Controls the execution of UEFI and Legacy PXE OpROM.

4.4.10 NVMe Configuration

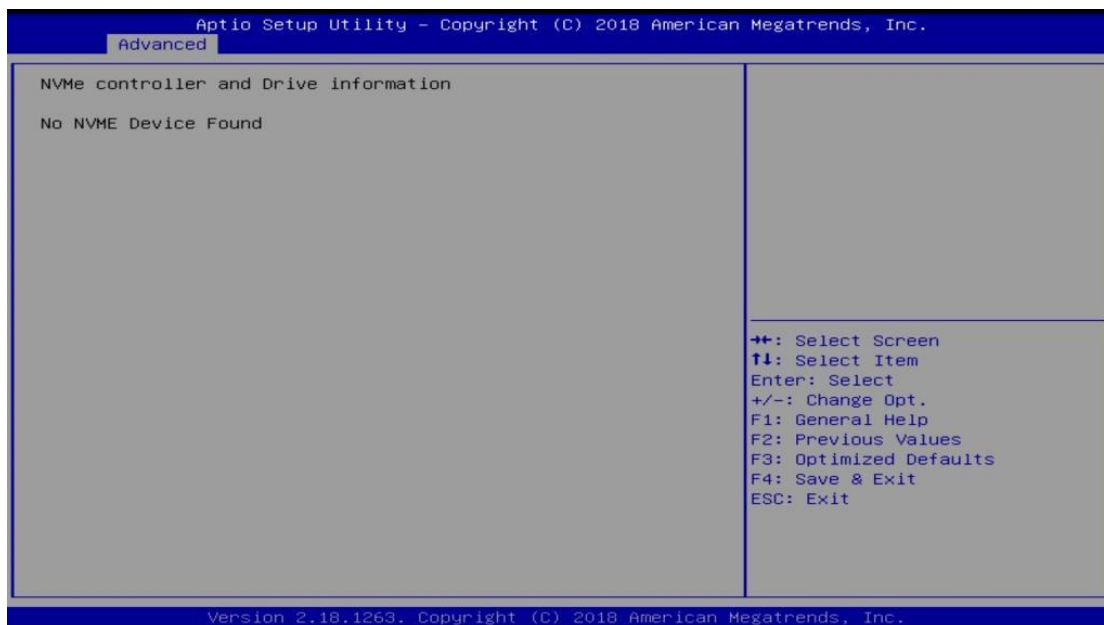

4.4.11 USB Configuration

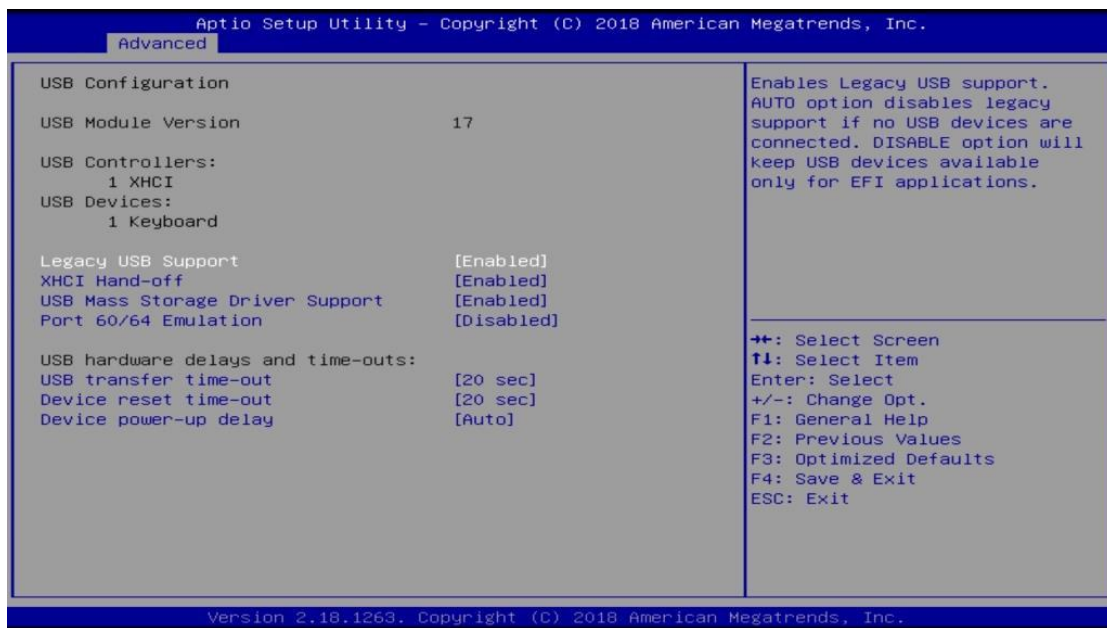

BIOS Setting	Description
Legacy USB Support	<ul style="list-style-type: none"> • Enable: Enables Legacy USB Support. • Auto: Disables legacy support if no USB devices are connected. • Disable: Keeps USB devices available only for EFI applications.
XHCI Hand-off	This is a workaround for OSes without XHCI hand-off support. The XHCI ownership change should be claimed by XHCI driver.
USB Mass Storage Driver Support	Enables / Disables the support for USB mass storage driver.
Port 60/64 Emulation	Enables I/O port 60h/64h emulation support. This should be enabled for the complete USB keyboard legacy support for non-USB aware OSes.
USB Transfer time-out	The time-out value for Control, Bulk, and Interrupt transfers.
Device reset time-out	Seconds of delaying execution of start unit command to USB mass storage device.
Device power-up delay	The maximum time the device will take before it properly reports itself to the Host Controller. "Auto" uses default value for a Root port it is 100ms. But for a Hub port, the delay is taken from Hub descriptor.

Appendix

This section provides the mapping addresses of peripheral devices and the sample code of watchdog timer configuration.

- I/O Port Address Map
- Interrupt Request Lines (IRQ)
- Watchdog Timer Configuration

A. I/O Port Address Map

Each peripheral device in the system is assigned a set of I/O port addresses which also becomes the identity of the device. The following table lists the I/O port addresses used.

Address	Device Description
0x00000000-0x00000CF7	PCI Express Root Complex
0x00000020-0x00000021	Programmable interrupt controller
0x00000024-0x00000025	Programmable interrupt controller
0x00000028-0x00000029	Programmable interrupt controller
0x0000002C-0x0000002D	Programmable interrupt controller
0x0000002E-0x0000002F	Motherboard resources
0x00000030-0x00000031	Programmable interrupt controller
0x00000034-0x00000035	Programmable interrupt controller
0x00000038-0x00000039	Programmable interrupt controller
0x0000003C-0x0000003D	Programmable interrupt controller
0x00000040-0x00000043	System timer
0x0000004E-0x0000004F	Motherboard resources
0x00000050-0x00000053	System timer
0x00000060-0x00000060	Standard PS/2 Keyboard
0x00000061-0x00000061	Motherboard resources
0x00000063-0x00000063	Motherboard resources
0x00000064-0x00000064	Standard PS/2 Keyboard
0x00000065-0x00000065	Motherboard resources
0x00000067-0x00000067	Motherboard resources
0x00000070-0x00000070	Motherboard resources
0x00000080-0x00000080	Motherboard resources
0x00000092-0x00000092	Motherboard resources
0x000000A0-0x000000A1	Programmable interrupt controller
0x000000A4-0x000000A5	Programmable interrupt controller
0x000000A8-0x000000A9	Programmable interrupt controller
0x000000AC-0x000000AD	Programmable interrupt controller
0x000000B0-0x000000B1	Programmable interrupt controller
0x000000B2-0x000000B3	Motherboard resources
0x000000B4-0x000000B5	Programmable interrupt controller
0x000000B8-0x000000B9	Programmable interrupt controller
0x000000BC-0x000000BD	Programmable interrupt controller

Address	Device Description
0x000000F0-0x000000F0	Numeric data processor
0x000003B0-0x000003BB	Intel(R) Xeon(R) E3 - 1200/1500 v5/6th Gen Intel(R) Core(TM) PCIe Controller (x16) - 1901
0x000003B0-0x000003BB	NVIDIA GeForce GTX 1080
0x000003C0-0x000003DF	Intel(R) Xeon(R) E3 - 1200/1500 v5/6th Gen Intel(R) Core(TM) PCIe Controller (x16) - 1901
0x000003C0-0x000003DF	NVIDIA GeForce GTX 1080
0x000003F8-0x000003FF	Communications Port (COM1)
0x000004D0-0x000004D1	Programmable interrupt controller
0x00000680-0x0000069F	Motherboard resources
0x00000A00-0x00000A0F	Motherboard resources
0x00000A10-0x00000A1F	Motherboard resources
0x00000A10-0x00000A1F	Motherboard resources
0x00000D00-0x0000FFFF	PCI Express Root Complex
0x0000164E-0x0000164F	Motherboard resources
0x00001800-0x000018FE	Motherboard resources
0x00001854-0x00001857	Motherboard resources
0x0000C000-0x0000DFFF	Intel(R) 100 Series/C230 Series Chipset Family SMBus - A123
0x0000C000-0x0000DFFF	PCI Express Upstream Switch Port
0x0000C000-0x0000DFFF	PCI Express Downstream Switch Port
0x0000D000-0x0000DFFF	PCI Express Downstream Switch Port
0x0000E000-0x0000EFFF	Intel(R) Xeon(R) E3 - 1200/1500 v5/6th Gen Intel(R) Core(TM) PCIe Controller (x16) - 1901
0x0000E000-0x0000EFFF	NVIDIA GeForce GTX 1080
0x0000F000-0x0000F01F	Intel(R) 100 Series/C230 Series Chipset Family SMBus - A123
0x0000F020-0x0000F03F	Standard SATA AHCI Controller
0x0000F040-0x0000F043	Standard SATA AHCI Controller
0x0000F050-0x0000F057	Standard SATA AHCI Controller
0x0000FF00-0x0000FFFE	Motherboard resources
0x0000FFFF-0x0000FFFF	Motherboard resources
0x0000FFFF-0x0000FFFF	Motherboard resources
0x0000FFFF-0x0000FFFF	Motherboard resources

B. Interrupt Request Lines (IRQ)

Peripheral devices use interrupt request lines to notify CPU for the service required. The following table shows the IRQ used by the devices on board.

Level	Function
IRQ 14	Motherboard resources
IRQ 17	High Definition Audio Controller
IRQ 13	Numeric data processor
IRQ 4294967293	Intel(R) 100 Series/C230 Series Chipset Family PCI Express Root Port #9 – A118
IRQ 4	Communications Port (COM1)
IRQ 0	System timer
IRQ 4294967294	Intel(R) Xeon(R) E3 - 1200/1500 v5/6th Gen Intel(R) Core(TM) PCIe Controller (x16) - 1901
IRQ 55 ~ IRQ 204	Microsoft ACPI-Compliant System
IRQ 256 ~ IRQ 511	Microsoft ACPI-Compliant System
IRQ 4294967276	Intel(R) Management Engine Interface
IRQ 4294967277	Intel(R) USB 3.0 eXtensible Host Controller - 1.0 (Microsoft)
IRQ 11	Intel(R) 100 Series/C230 Series Chipset Family SMBus - A123
IRQ 11	Intel(R) 100 Series/C230 Series Chipset Family Thermal subsystem - A131
IRQ 4294967279 ~ IRQ 4294967284	Intel(R) Ethernet Connection (2) I211-V
IRQ 4294967285 ~ IRQ 4294967290	Intel(R) Ethernet Connection (2) I211-V #2
IRQ 4294967291	Intel(R) Ethernet Connection (2) I219-V
IRQ 4294967278	NVIDIA GeForce GTX 1080
IRQ 8	System CMOS/real time clock
IRQ 16	High Definition Audio Controller
IRQ 14	Motherboard resources
IRQ 17	High Definition Audio Controller
IRQ 13	Numeric data processor
IRQ 4294967292	Standard SATA AHCI Controller
IRQ 4	Communications Port (COM1)
IRQ 0	System timer

C. Watchdog Timer Configuration

The Watchdog Timer (WDT) is used to generate a variety of output signals after a user programmable count. The WDT is suitable for the use in the prevention of system lock-up, such as when software becomes trapped in a deadlock. Under these sorts of circumstances, the timer will count to zero and the selected outputs will be driven.

Under normal circumstance, you will need to restart the WDT at regular intervals before the timer counts to zero.

1. Sample Code: The file NCT5523D.H

```
//-----
//
// THIS CODE AND INFORMATION IS PROVIDED "AS IS" WITHOUT WARRANTY OF ANY
// KIND, EITHER EXPRESSED OR IMPLIED, INCLUDING BUT NOT LIMITED TO THE
// IMPLIED WARRANTIES OF MERCHANTABILITY AND/OR FITNESS FOR A PARTICULAR
// PURPOSE.
//
//-----
#ifndef __NCT5523D_H
#define __NCT5523D_H          1
//-----
#define NCT5523D_INDEX_PORT (NCT5523D_BASE)
#define NCT5523D_DATA_PORT (NCT5523D_BASE+1)
//-----
#define NCT5523D_REG_LD      0x07
//-----
#define NCT5523D_UNLOCK     0x87
#define NCT5523D_LOCK       0xAA
//-----
unsigned int Init_NCT5523D(void);
void Set_NCT5523D_LD( unsigned char);
void Set_NCT5523D_Reg( unsigned char, unsigned char);
unsigned char Get_NCT5523D_Reg( unsigned char);
//-----
#endif    //__NCT5523D_H
```

2. Sample Code: The file MAIN.CPP

```
//-----  
//  
// THIS CODE AND INFORMATION IS PROVIDED "AS IS" WITHOUT WARRANTY OF ANY  
// KIND, EITHER EXPRESSED OR IMPLIED, INCLUDING BUT NOT LIMITED TO THE  
// IMPLIED WARRANTIES OF MERCHANTABILITY AND/OR FITNESS FOR A PARTICULAR  
// PURPOSE.  
//  
//-----  
#include <dos.h>  
#include <conio.h>  
#include <stdio.h>  
#include <stdlib.h>  
#include "NCT5523D.H"  
//-----  
int main (void);  
  
void WDTInitial(void);  
void WDTEnable(unsigned char);  
void WDTDisable(void);  
  
//-----  
int main (void)  
{  
    char SIO;  
  
    SIO = Init_NCT5523D();  
    if (SIO == 0)  
    {  
        printf("Can not detect Nuvoton NCT5523D, program abort.\n");  
        return(1);  
    }  
  
    WDTInitial();  
  
    WDTEnable(10);  
  
    WDTDisable();  
  
    return 0;  
}  
//-----  
void WDTInitial(void)  
{  
    unsigned char bBuf;  
    Set_NCT5523D_LD(0x08);                //switch to logic device 8  
    bBuf = Get_NCT5523D_Reg(0x30);  
    bBuf &= (~0x01);  
    Set_NCT5523D_Reg(0x30, bBuf);        //Enable WDTO  
}  
//-----  
void WDTEnable(unsigned char NewInterval)  
{
```

```
unsigned char bBuf;

Set_NCT5523D_LD(0x08);           //switch to logic device 8
Set_NCT5523D_Reg(0x30, 0x01);   //enable timer

bBuf = Get_NCT5523D_Reg(0xF0);
bBuf &= (~0x08);
Set_NCT5523D_Reg(0xF0, bBuf);   //count mode is second

Set_NCT5523D_Reg(0xF1, NewInterval); //set timer
}
//-----
void WDTDisable(void)
{
    Set_NCT5523D_LD(0x08);           //switch to logic device 8
    Set_NCT5523D_Reg(0xF1, 0x00);   //clear watchdog timer
    Set_NCT5523D_Reg(0x30, 0x00);   //watchdog disabled
}
//-----
```

3. Sample Code: The file NCT5523D.CPP

```
//-----  
//  
// THIS CODE AND INFORMATION IS PROVIDED "AS IS" WITHOUT WARRANTY OF ANY  
// KIND, EITHER EXPRESSED OR IMPLIED, INCLUDING BUT NOT LIMITED TO THE  
// IMPLIED WARRANTIES OF MERCHANTABILITY AND/OR FITNESS FOR A PARTICULAR  
// PURPOSE.  
//  
//-----  
#include "NCT5523D.H"  
#include <dos.h>  
//-----  
unsigned int NCT5523D_BASE;  
void Unlock_NCT5523D (void);  
void Lock_NCT5523D (void);  
//-----  
unsigned int Init_NCT5523D(void)  
{  
    unsigned int result;  
    unsigned char ucDid;  
  
    NCT5523D_BASE = 0x4E;  
    result = NCT5523D_BASE;  
  
    ucDid = Get_NCT5523D_Reg(0x20);  
    if (ucDid == 0xC4)                //NCT5523D??  
    {    goto Init_Finish; }  
  
    NCT5523D_BASE = 0x2E;  
    result = NCT5523D_BASE;  
  
    ucDid = Get_NCT5523D_Reg(0x20);  
    if (ucDid == 0xC4)                //NCT5523D??  
    {    goto Init_Finish; }  
  
    NCT5523D_BASE = 0x00;  
    result = NCT5523D_BASE;  
  
Init_Finish:  
    return (result);  
}  
//-----  
void Unlock_NCT5523D (void)  
{  
    outportb(NCT5523D_INDEX_PORT, NCT5523D_UNLOCK);  
    outportb(NCT5523D_INDEX_PORT, NCT5523D_UNLOCK);  
}  
//-----  
void Lock_NCT5523D (void)  
{  
    outportb(NCT5523D_INDEX_PORT, NCT5523D_LOCK);  
}  
//-----
```



```
void Set_NCT5523D_LD( unsigned char LD)
{
    Unlock_NCT5523D();
    outportb(NCT5523D_INDEX_PORT, NCT5523D_REG_LD);
    outportb(NCT5523D_DATA_PORT, LD);
    Lock_NCT5523D();
}
//-----
void Set_NCT5523D_Reg( unsigned char REG, unsigned char DATA)
{
    Unlock_NCT5523D();
    outportb(NCT5523D_INDEX_PORT, REG);
    outportb(NCT5523D_DATA_PORT, DATA);
    Lock_NCT5523D();
}
//-----
unsigned char Get_NCT5523D_Reg(unsigned char REG)
{
    unsigned char Result;
    Unlock_NCT5523D();
    outportb(NCT5523D_INDEX_PORT, REG);
    Result = inportb(NCT5523D_DATA_PORT);
    Lock_NCT5523D();
    return Result;
}
//-----
```