



ARCHMI-7XX

7", 8", 10.1", 12.1" and 15", Intel Atom Low Power N2600/D2550,
Fanless Industrial Compact Size Panel PC

User Manual

Release Date

Apr. 2016

Revision

V2.1

©2016 Aplex Technology, Inc.

All Rights Reserved.

Published in Taiwan

Aplex Technology, Inc.

15F-1, No.186, Jian Yi Road, Zhonghe District, New Taipei City 235, Taiwan

Tel: 886-2-82262881 Fax: 886-2-82262883 URL: www.aplextec.com

Revision History

Reversion	Date	Description
1.0	2013/05/09	Official Version
1.1	2013/09/25	Modify Dimension and Net Weight Specification, add notice in P.7 and P.8, modify the images in Chapter 4
1.2	2014/01/08	Add French warning description at P.2 and P.3, modify motherboard and product Specifications
1.3	2014/01/13	Update to V1.3
1.4	2014/08/01	Add French warning description which on the sticker at P.2
1.5	2014/08/13	Add steps of how to reach switch position at P.26~P.28
1.6	2014/10/13	Add 10.1" Product Specifications
1.7	2015/06/17	Add VESA Mount and Panel Mount Description
1.8	2105/08/26	Modify "OS Support" Spec.
1.9	2015/10/20	Add "UL" Certificate, Modify Expansion slot Specifications
2.0	2016/02/02	Add Power Consumption Specifications, 1.1 Features, and D2550 CPU and 4GB memory for option, Modify Net Weight, 17" LCD, dimension images, and IO Port Specification
2.1	2016/04/19	Add warning words about UL certificate

Warning!

This equipment generates, uses and can radiate radio frequency energy and if not installed and used in accordance with the instructions manual, it may cause interference to radio communications. It has been tested and found to comply with the limits for a Class A computing device pursuant to FCC Rules, which are designed to provide reasonable protection against such interference when operated in a commercial environment. Operation of this equipment in a residential area is likely to cause interference in which case the user at his own expense will be required to take whatever measures may be required to correct the interference.

Electric Shock Hazard – Do not operate the machine with its back cover removed. There are dangerous high voltages inside.

Avertissement!

Cet équipement génère, utilise et peut émettre une énergie de radiofréquence et s'il n'est pas installé et utilisé conformément au manuel d'instructions, il peut provoquer des interférences dans les communications radio. Il a été testé et approuvé conforme aux limites pour un dispositif de classe A et selon les règles de la FCC, qui sont conçues pour fournir une protection raisonnable contre de telles interférences dans un environnement commercial. Le fonctionnement de cet équipement dans une zone résidentielle est susceptible de provoquer des interférences, dans ce cas l'utilisateur, à ses propres frais, devra faire le nécessaire pour prendre toutes les mesures requises pour corriger le problème.

Risque de choc électrique - Ne pas faire fonctionner la machine avec son capot arrière enlevé. Des tensions dangereuses sont élevées à l'intérieur.

Caution

Risk of explosion if the battery is replaced with an incorrect type.
Batteries should be recycled where possible. Disposal of used batteries must be in accordance with local environmental regulations.

Precaution

Risque d'explosion si la pile usagée est remplacée par une pile de type incorrect.
Les piles usagées doivent être recyclées dans la mesure du possible. La mise au rebut des piles usagées doit respecter les réglementations locales en vigueur en matière de protection de l'environnement.

Disclaimer

This information in this document is subject to change without notice. In no event shall Apex Technology Inc. be liable for damages of any kind, whether incidental or consequential, arising from either the use or misuse of information in this document or in any related materials.

**This product is intended to be supplied by a Listed Power Adapter or DC power source, output meets SELV, rated 9-36Vdc, 4.5-1.5A or 12Vdc, 4.5A or 19Vdc, 6.31A., T_{ma} = 50degree C, and the altitude of operation = 2000m.
If need further assistance with purchasing the power source, please contact to manufacturer for further information**

Packing List

Accessories (as ticked) included in this package are:
<input type="checkbox"/> Adaptor
<input type="checkbox"/> Driver & manual CD disc
<input type="checkbox"/> Other. _____ (please specify)

Safety Precautions

Follow the messages below to prevent your systems from damage:

- ◆ Avoid your system from static electricity on all occasions.
- ◆ Prevent electric shock. Don't touch any components of this card when the card is power-on. Always disconnect power when the system is not in use.
- ◆ Disconnect power when you change any hardware devices. For instance, when you connect a jumper or install any cards, a surge of power may damage the electronic components or the whole system.

Consignes de sécurité

Suivez les messages ci-dessous pour éviter que vos systèmes contre les dommages:

- ◆ Éviter votre système contre l'électricité statique sur toutes les occasions.
- ◆ Évitez les chocs électriques. Ne pas toucher les composants de cette carte lorsque la carte est sous tension. Toujours débrancher lorsque le système n'est pas en cours d'utilisation.
- ◆ Couper l'alimentation électrique lorsque vous changez tous les périphériques matériels. Par exemple, lorsque vous connectez un cavalier ou d'installer des cartes, une forte augmentation de la puissance peut endommager les composants électroniques ou l'ensemble du système.

Table of Contents

Revision History.....	1
Warning!/Avertissement!.....	2
Caution/Precaution/Disclaimer.....	3
Packing List/ Safety Precautions/Consignes de sécurité.....	4

Chapter 1 Getting Started

1.1 Features.....	7
1.2 Specifications.....	7
1.3 Dimensions.....	10
1.4 Brief Description of ARCHMI Series.....	15
1.5 Installation of HDD (ARCHMI-707/708(P)).....	17
1.6 Installation of HDD (ARCHMI-710(P)).....	19
1.7 Installation of HDD (ARCHMI-712/715(P)).....	20
1.8 VESA Mounting.....	22
1.9 Panel Mounting.....	22

Chapter 2 Hardware

2.1 Motherboard Introduction.....	23
2.2 Motherboard Specifications.....	23
2.3 Jumpers Setting and Connectors.....	27

Chapter 3 BIOS Setup

3.1 Operations after POST Screen.....	52
3.2 BIOS Setup Utility.....	52
3.3 Main Settings.....	53
3.4 Advanced Settings.....	54
3.5 Chipset Settings.....	60
3.6 Boot Settings.....	63
3.7 Security Settings.....	65
3.8 Save and Exist Settings.....	66

Chapter 4 Installation of Drivers

4.1 Intel Chipset Driver.....	69
4.2 Intel Graphics Media Accelerator Driver.....	72
4.3 Intel (R) Network Adapter.....	75
4.4 Realtek ALC662 HD Audio Driver Installation.....	77

5.1 Windows 2003/XP/Vista/7 Universal Driver Installation for PenMount 6000 Series.....	79
5.2 Software Functions.....	89

Figures

Figure 1.1: Dimensions of ARCHMI-707(P).....	10
Figure 1.2: Dimensions of ARCHMI-708(P).....	11
Figure 1.3: Dimensions of ARCHMI-710(P).....	12
Figure 1.4: Dimensions of ARCHMI-712(P).....	13
Figure 1.5: Dimensions of ARCHMI-715(P).....	14
Figure 1.6: Front View of ARCHMI SERIES.....	15
Figure 1.7: Rear View of ARCHMI-707(P)/ARCHMI-708(P).....	16
Figure 1.8: Rear View of ARCHMI-710(P).....	16
Figure 1.9: Rear View of ARCHMI-712(P)/ARCHMI-715(P).....	16
Figure 1.10: ARCHMI Series VESA Mounting.....	22
Figure 1.11: ARCHMI Series Panel Mounting.....	22
Figure 2.1: Mainboard Dimensions.....	25
Figure 2.2: Jumpers and Connectors Location_ Board Top.....	26
Figure 2.3: Jumpers and Connectors Location_ Board Bottom...	26

Chapter 1

Getting Started

1.1 Features

- Variety of LCD Panel Size selections
- Flat Front Panel with IP65 Design
- Solid Aluminum Die-casting Chassis
- Intel Atom N2600 processor, Dual Core Low Power Fanless System

1.2 Specifications

	ARCHMI -707(P)	ARCHMI -708(P)	ARCHMI -710(P)	ARCHMI -712(P)	ARCHMI -715(P)
System					
CPU	Intel Atom Cedar View N2600 1.6GHz Dual Core Processors /Intel Atom D2550 1.8GHz (Optional for ARCHMI-710(P)/712(P)/715(P) only)				
System Chipset	Intel NM10				
System Memory	Onboard DDR3 2GB 800 MHz /4GB (Optional for ARCHMI-710(P)/712(P)/715(P) only)				
IO Port					
USB	2 x USB 2.0 type A, USB4/5				
Serial/ Parallel	1 x RS-232/422/485 DB-9, COM1, Default RS-232 1 x RS-232 DB-9, COM2				
Audio	1 x Line out phone jack				
LAN	2 x GbE LAN RJ-45				
Power	3 pins terminal block connector, DC Power input				
Optional Outside I/O Port (Not for 7" and 8" HMI)	2 x RS-232 DB-9 +1 x Mini-PCIe slot via TB-528C2ME1 (For ARCHMI-710(P)/712(P)/715(P)) 2 x CAN bus via TB-528CAN2 (For ARCHMI-710(P)/712(P)/715(P)) 2 x USB 2.0 type A +1 x Mini-PCIe slot +1 x RS-232 DB-9 + 1 x Power button via TB-528C1U2P1 (For ARCHMI-710(P)) 2 x USB 2.0 type A +1 x Mini-PCIe slot via TB-528U2ME1 (For ARCHMI-712(P)/715(P))				
Storage Space					
HDD	1 x 1.8" SATA 2 half size		1 x 2.5" SATA 2		
Movable device	1 x Internal SD slot, up to 32GB				
Expansion					
Expansion Slot	1 x Internal Mini-PCIe half size				
Display					
Display Type	7" TFT-LCD	8" TFT-LCD	10.1" TFT-LCD	12.1" TFT-LCD	15" TFT-LCD
Max. Resolution	800x480	800x600	1280x800	800x600	1024x768
Max. Color	262K	16.2M	262K	16.2M	16.2M
Luminance (cd/m ²)	350	350	350	450	350

View angle(H°/V°)	140/120	140/125	160/160	160/140	160/145
Contrast Ratio	400:1	500:1	800:1		
Backlight Lifetime	40,000 Hrs			50,000 Hrs	
Touch Screen					
Type	Resistive Touch / Projected Capacitive Touch (for P model)				
Interface	RS-232 / USB (for P model)				
Light Transmission	80% / 90% (for P model)				
Power					
Power Input	9~36V DC				
Power Consumption	MAX:12.8W(707) MAX:13.0W(707P)	MAX:15.2W(708) MAX:15.2W(708P)	MAX:11W(710) MAX:11W(710P)	MAX:18W(712) MAX:18W(712P)	MAX:19.2W(715) MAX:19.2W(715P)
Mechanical					
Construction	Sliver aluminum front bezel and chassis				
IP Rating	IP65 front panel				
Mounting	Panel mounting, VESA 75 x 75		Panel mounting, VESA 100 x 100		
Dimension (mm)	202 x 149 x 40	231.1 x 176.1 x 50	285 x 189 x 48.9	319 x 245 x 51.7	410 x 310 x 54.7
Net Weight (Kgs)	1.2	1.8	2.1	2.5	4.4
Environmental					
Operating Temperature	0~50°C -20~60°C (option)				
Storage temperature	-20~60°C				
Storage humidity	10 to 90% @ 40°C, non- condensing				
Certification	CE / FCC Class A / UL				
Operating System Support	Windows XP Pro, Windows XP Embedded, Windows Embedded CE6.0(Note 1), Windows 7 32-bit pro for Embedded, Windows Embedded standard 7 32-bit (Win 7 32-bit support 3D Graphic function)				

Note 1: ARCHMI series is covered by one or more of the following patents: US6, 570, 884, US6,115,776, and US6,327,625.

** Please be notice.

Due to the limitation for Intel N2000/D2000 EMGD driver, therefore ARCHMI will have some limitation under XP.

1. The Intel EMGD driver version is v1.15
2. It will have the unknown device under device management due to not support the Intel HDA device (refer to the photo below)
3. It will need install the correct driver by LCD panel size/resolution, totally four version : 800*480, 800*600, 1024*768(18bit), 1024*768(24bit)
4. The original driver not support VGA display will have to customize

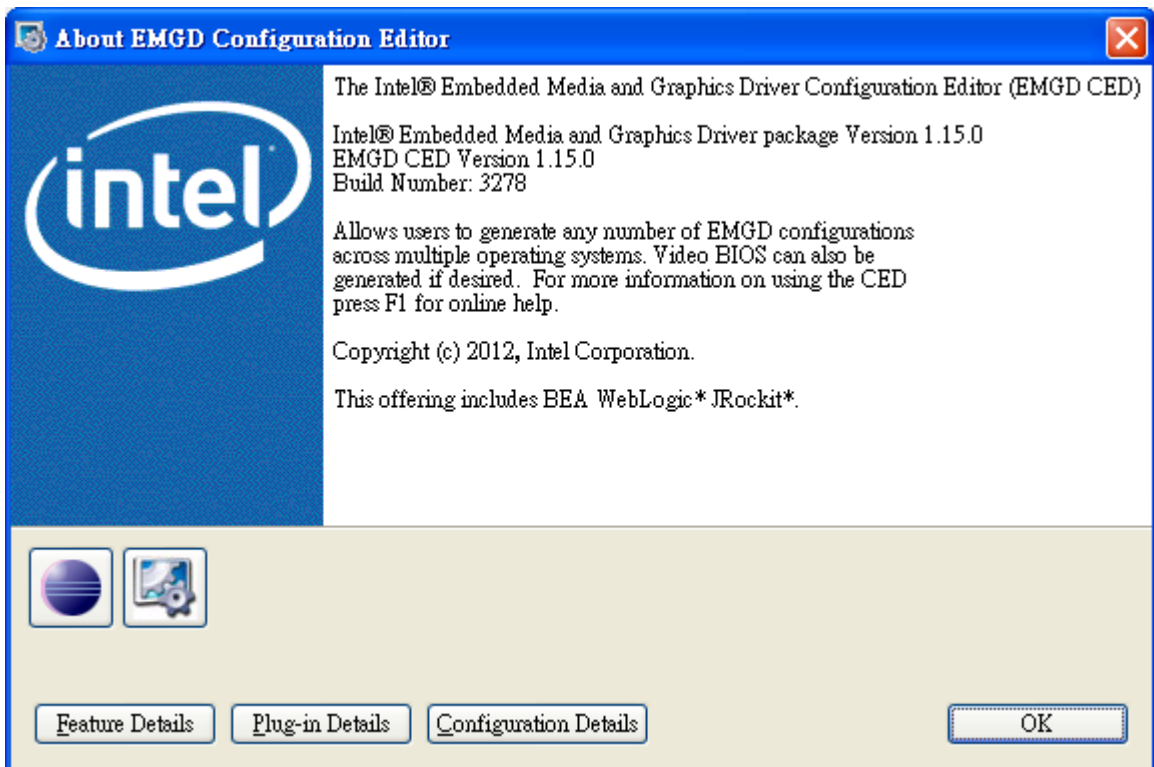
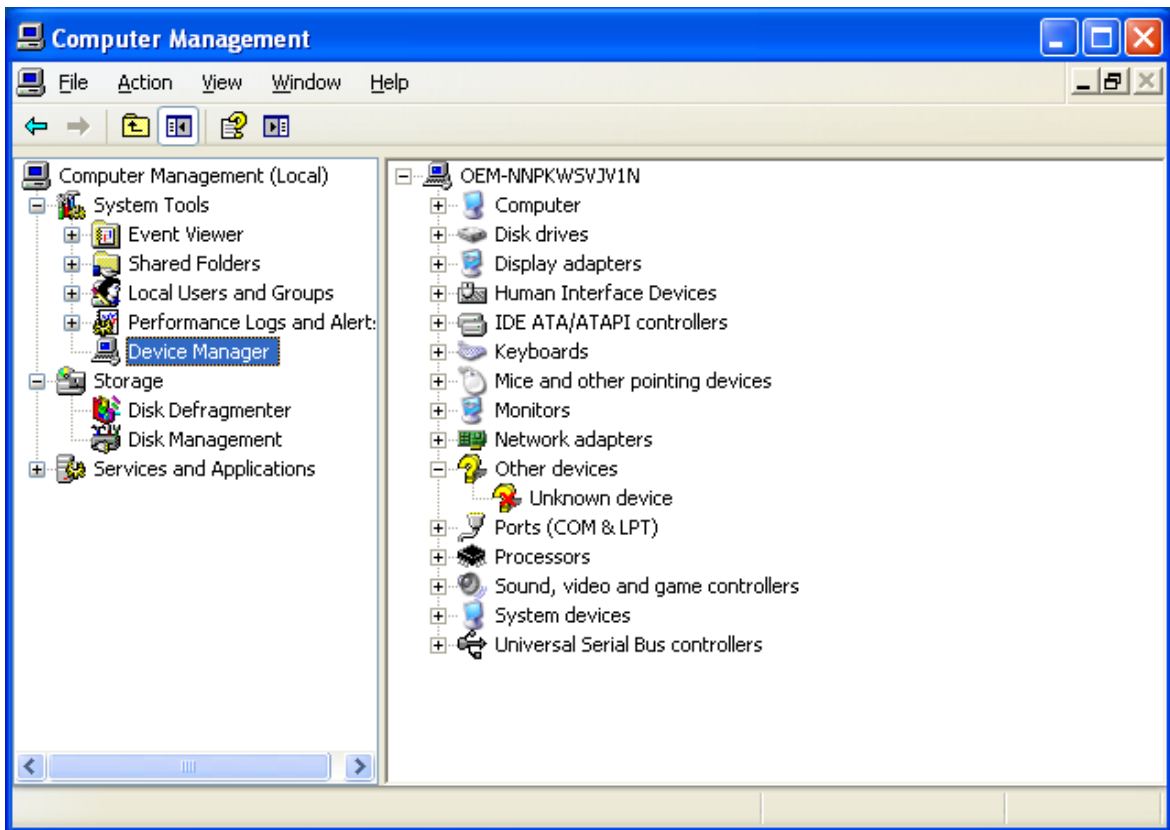

1.3 Dimensions

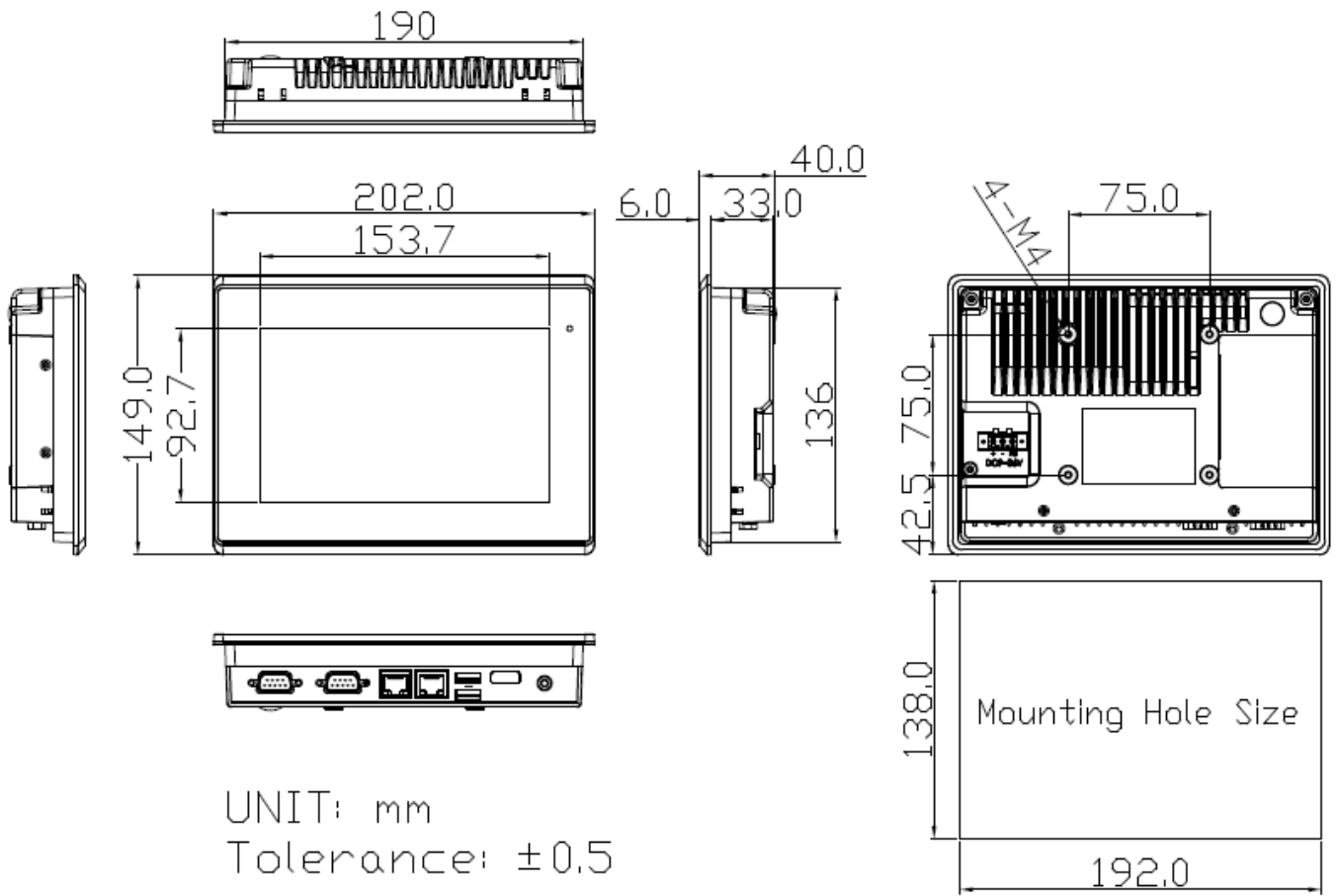

Figure 1.1: Dimensions of ARCHMI-707(P)

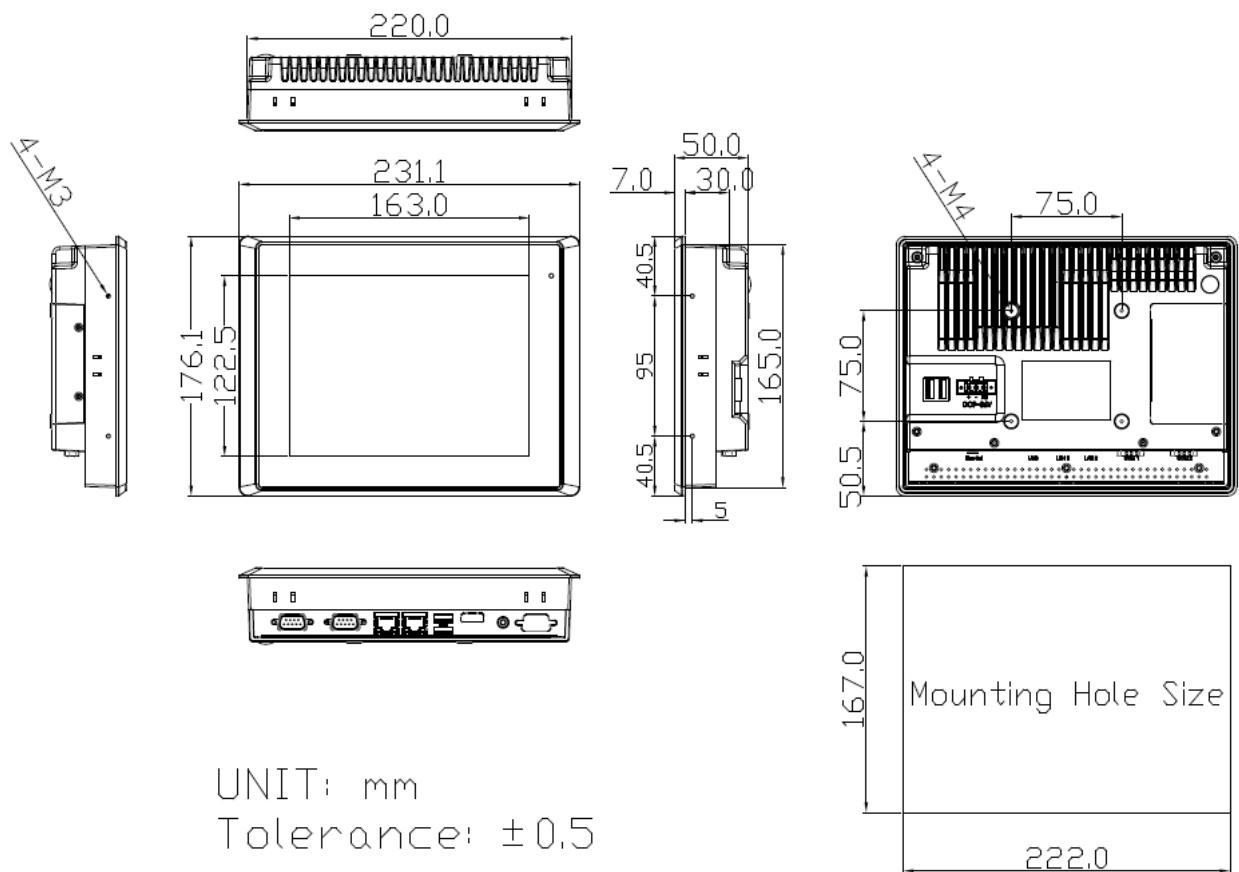

Figure 1.2: Dimensions of ARCHMI-708(P)

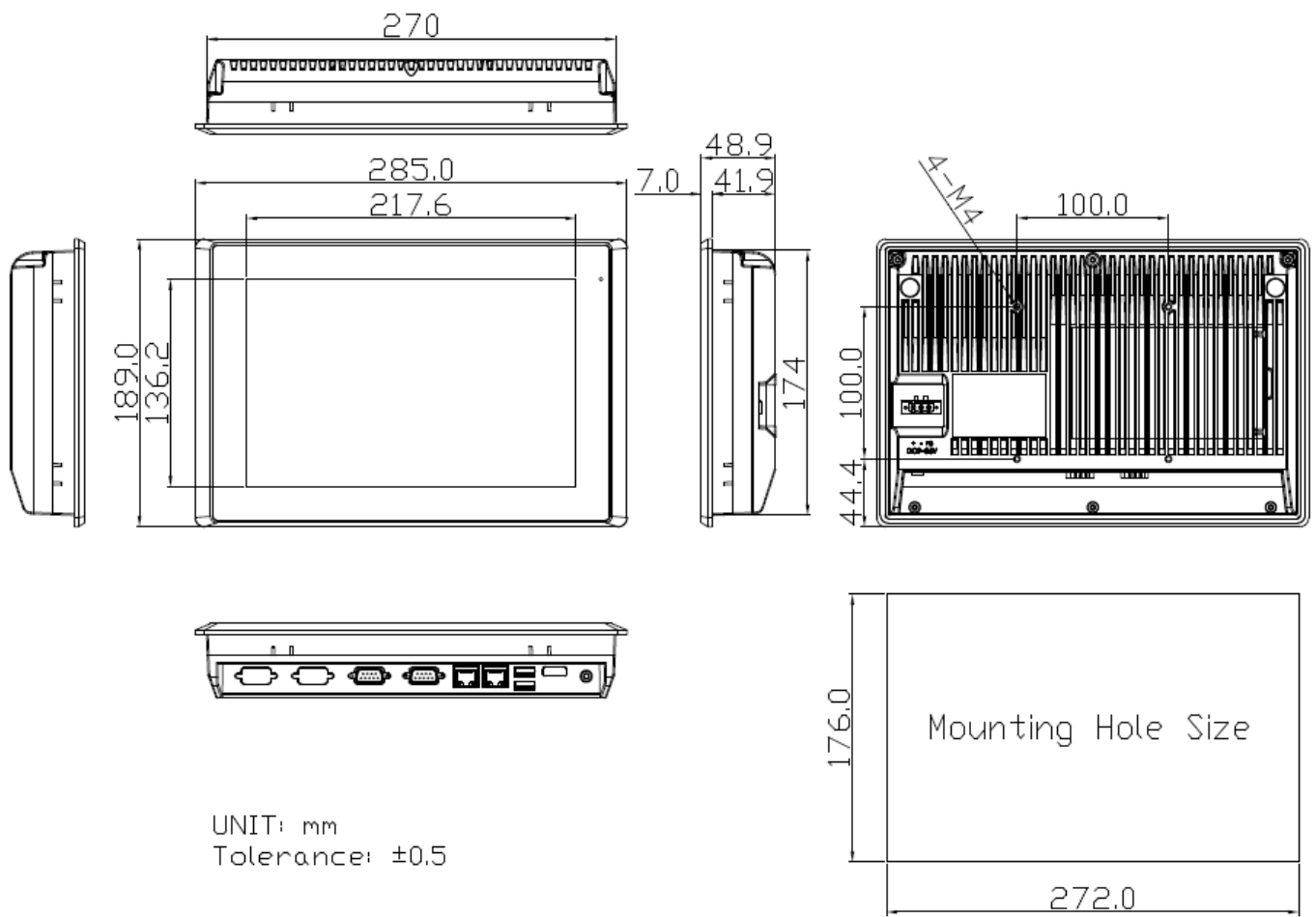

Figure 1.3: Dimensions of ARCHMI-710(P)

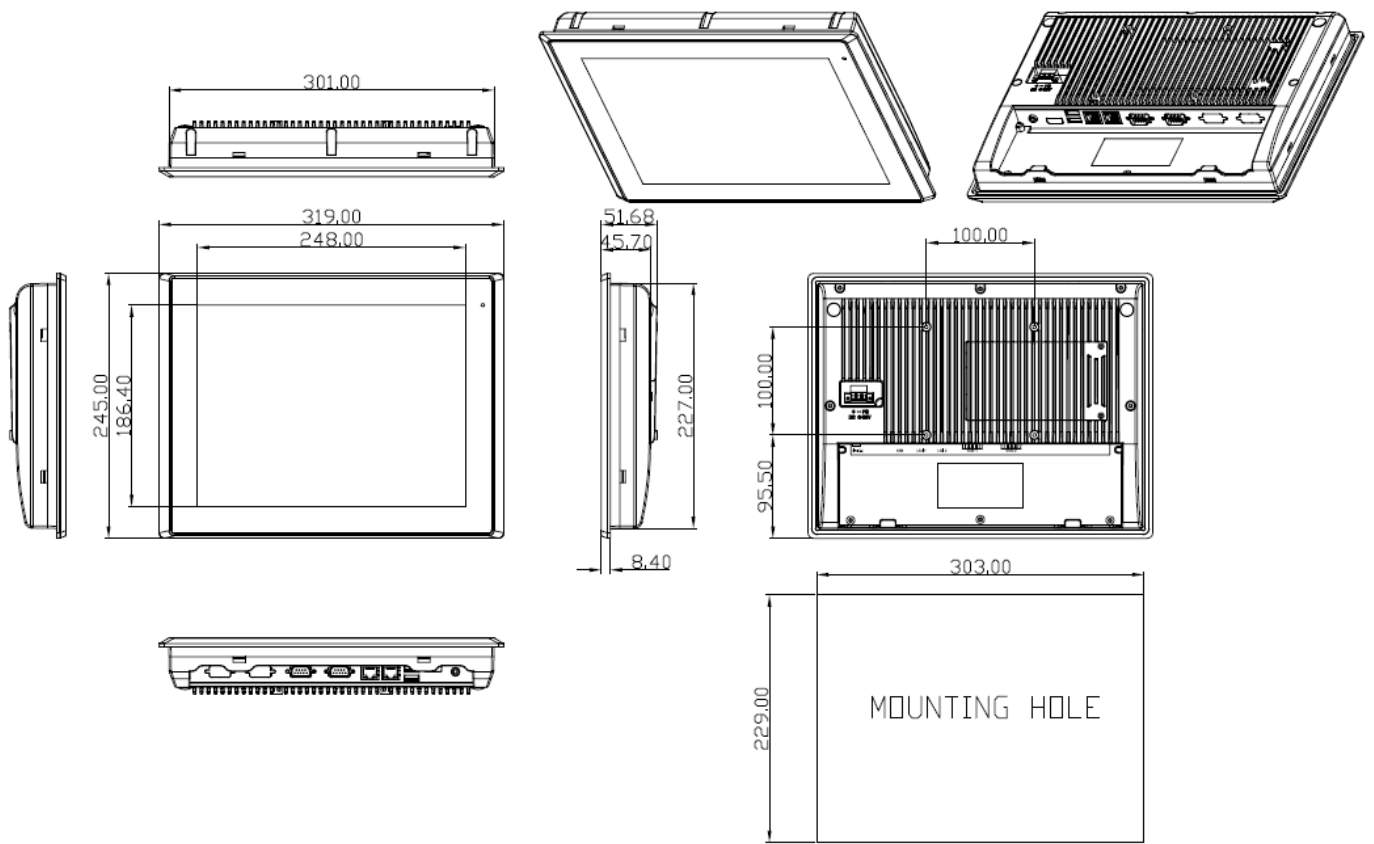

Figure 1.4: Dimensions of ARCHMI-712(P)

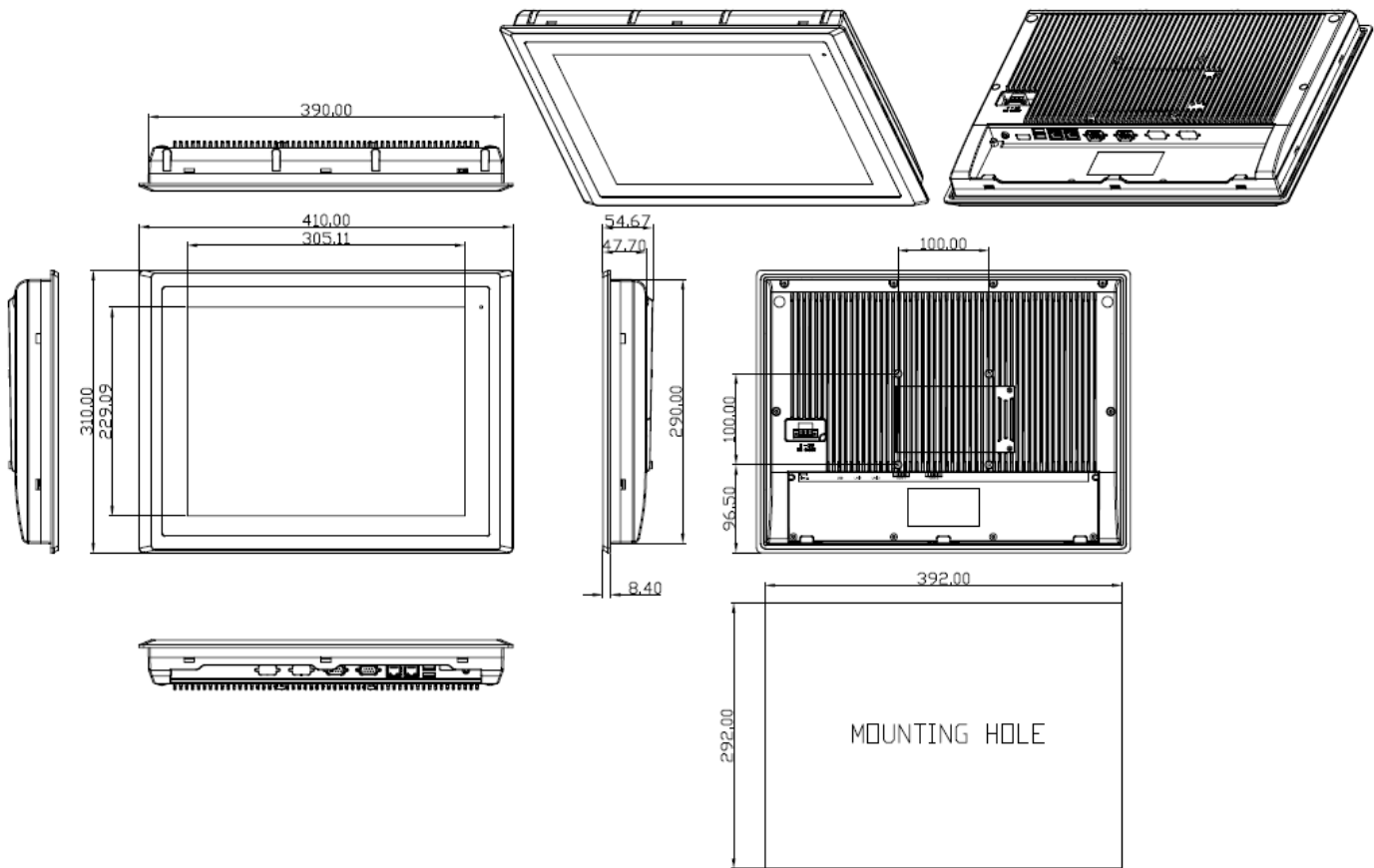

Figure 1.5: Dimensions of ARCHMI-715(P)

1.4 Brief Description of ARCHMI Series

There are 7", 8", 10.1", 12.1", 15", Industrial Compact Size Panel PC in ARCHMI series, which comes with flat front panel touch screen and fanless design. It is powered by Intel Atom N2600 1.6GHz CPU built-in, 2GB DDR III 800 MHz, and now it also can be powered by Intel Atom D2550 1.8GHz CPU built-in, 4GB DDR III 800MHz optional for ARCHMI-712, ARCHMI-710 and ARCHMI-715. ARCHMI series is 9~36VDC wide-ranging power input and IP65 compliant front panel. Optional projected capacitive touch screen support 7H anti-scratch surface is ideal for use as a PC-based controller for Industrial Automation & Factory Automation.



Figure 1.6: Front View of ARCHMI SERIES



Figure 1.7: Rear View of ARCHMI -707(P)/ARCHMI -708(P)



Figure 1.8: Rear View of ARCHMI-710(P)

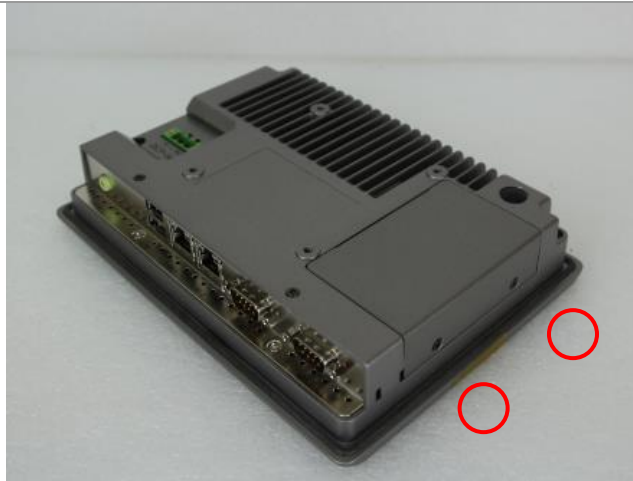

Figure 1.9: Rear View of ARCHMI -712(P)/ ARCHMI- 715(P)

1.5 Installation of HDD (ARCHMI-707/708(P))

Step 1

There are 2 screws to deal with when enclosing or removing the chassis. Gently remove 2 screws.



Step 2

There is a SSD card in the bracket. Gently remove the screw, then carefully pull SSD card.



Step 3

Take out SSD Card bracket.



Step 4.

You can replace SSD card by unscrewing 4 screws as shown in the picture.

Note: 4 screws are packed in the packing list.

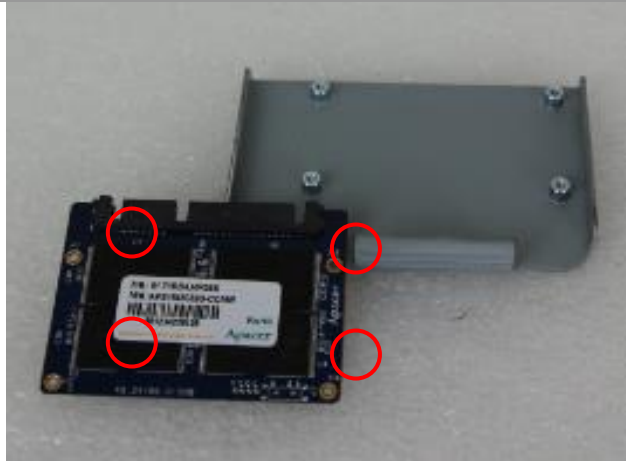

Step 5

There is a SD card hole in the side of the machine. You can replace SD card from there.



Step 6.

Gently screw the screws.



1.6 Installation of HDD (ARCHMI-710(P))

Step 1

There are 2 screws to deal with when enclosing or removing the chassis. Gently remove 2 screws.

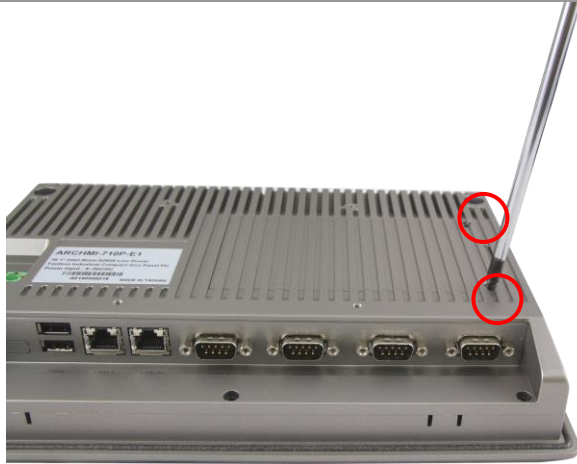

Step 2

Take the storage cover beside the Panel PC.



Step 3

You can put or remove HDD into the machine by pulling the HDD bracket.



Step 4.

There is a SD hole in the side of machine. You can replace SD card from there.



1.7 Installation of HDD (ARCHMI-712/715(P))

Step 1

There are 2 screws to deal with when enclosing or removing the chassis. Gently remove 2 screws.



Step 2

You can put or remove HDD into the machine by pulling the HDD bracket.



Step 3

You can remove HDD by unscrewing 4 screws in the HDD bracket.

Note: 4 screws are packed in the packing package.



Step 4

There is a SD hole in the side of machine. You can replace SD card from there.



1.8 VESA Mounting

The ARCHMI series is designed to be VESA mounted as shown in Picture. Just carefully place the unit through the hole and tighten the given screws from the rear to secure the mounting.

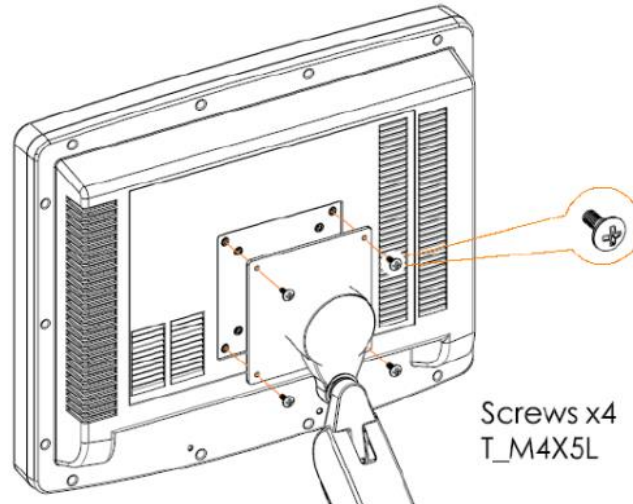

Figure 1.10: ARCHMI Series VESA Mounting

1.9 Panel Mounting

There are four holes located along the four sides of the HMI. Insert the clamp from the four sides and tighten them with the nuts provided.

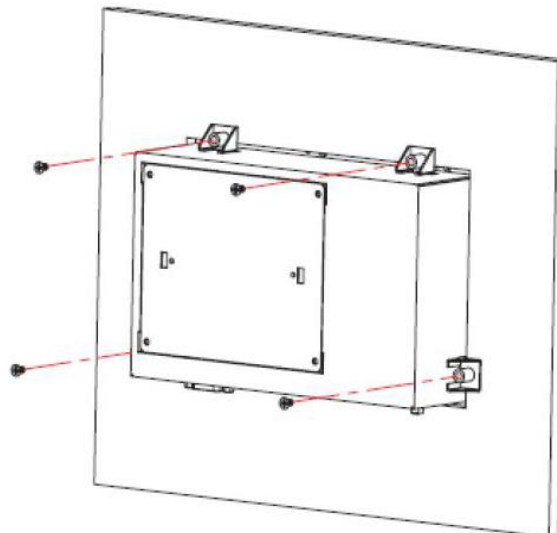

Figure 1.11: ARCHMI Series Panel Mounting

2.1 Motherboard Introduction

SBC-7106 is a 4" industrial motherboard developed on the basis of Intel Cedarview-M Processors and NM10, which provides abundant peripheral interfaces to meet the needs of different customers. Also, it features dual GbE ports, 3-COM ports and one Mini PCIE configuration, one VGA port, one HDMI port, one LVDS interface. To satisfy the special needs of high-end customers, CN1 and CN2 and CN3 richer extension functions. The product is widely used in various sectors of industrial control.

2.2 Motherboard Specifications

Specifications	
Board Size	170mm x 113mm
CPU Support	Intel Atom N2600 /1.60GHz (2cores,3.5W, onboard) Intel Atom D2550 /1.86GHz(2cores,10W, option)
Chipset	Intel NM10 Express
Memory Support	Onboard 2GB DDRIII SDRAM (N2600) Onboard 4GB DDRIII SDRAM (D2550)
Graphics	Integrated Intel GMA 3600 (N2600) Integrated Intel GMA 3650
Display Mode	1 x CRT Port 1 x HDMI Port 1 x LVDS1 (18/24-bit single LVDS)
Support Resolution	Up to 1920 x1200 for CRT Up to 1920 x1200 for HDMI Up to 1366 x768 for LVDS1 (N2600) Up to 1440 x 900 for LVDS1 (D2550)
Dual Display	CRT+LVDS1 CRT+HDMI LVDS1+HDMI
Super I/O	Winbond W83627UHG-E

BIOS	AMIBIOS
Storage	1 x SATA Connector (7P) 1 x SATA Connector (7P+15P) 1 x SD Socket (USB to SD)
Ethernet	2 x PCIe Gbe LAN by Realtek RTL8111E
USB	2 x USB 2.0 (type A)stack ports (USB4/USB5) 2 x USB 2.0 Pin header for CN3 (USB2/USB3) 2 x USB 2.0 Pin header for CN1 (USB0/USB1) 1 x USB 2.0 for MPCIE1 (USB7)
Serial	1 x RS232/RS422/RS485 port, DB9 connector for external (COM1) pin 9 w/5V/12V/Ring select 1 x RS232 port, DB9 connector for external (COM2) pin 9 w/5V/12V/Ring select 1 x RS422/485 header for CN2 (COM3) 2 x UART for CN3 (COM5,COM6)
Digital I/O	8-bit digital I/O by Pin header (CN2) 4-bit digital Input 4-bit digital Output 4-bit digital I/O by Pin header (CN3) 2-bit digital Input 2-bit digital Output
Battery	Support CR2477 Li battery by 2-pin header
Audio	Support Audio via Realtek ALC662 HD audio codec Support Line-in, Line-out, MIC by 2x6-pin header
Keyboard /Mouse	1 x PS2 keyboard/mouse by 1x6 box pin header (CN3)
Expansion Bus	1 x mini-PCI-express slot 1 x PCI-express (CN3)
Touch Ctrl	1 x Touch ctrl header for TCH1 (COM4)
Power Management	Wide Range DC9V~36V input 1 x 3-pin power input connector

Switches and LED Indicators	1 x Power on/off switch (CN1) 1 x Reset switch (CN1) 1 x Power LED status (CN1) 1 x HDD LED status (CN1) 1 x Buzzer
External I/O port	2 x COM Ports (COM1/COM2) 2 x USB 2.0 Ports (stack) 2 x RJ45 GbE LAN Ports 1 x HDMI Port 1 x Stack audio Jack (Line out)
Watchdog Timer	Software programmable 1 – 255 second by Super I/O
Temperature	Operating: -20°C to 70°C Storage: -40°C to 85°C
Humidity	5% - 95%, non-condensing, operating
Power Consumption	12V /0.95A (Intel Atom N2600 processor with 2GB DDR3 DRAM)
EMI/EMS	Meet CE/FCC class A
TB-528CAN2	2 x CAN bus
	1 x SIM Card Socket
	1 x mini-PCI-express slot

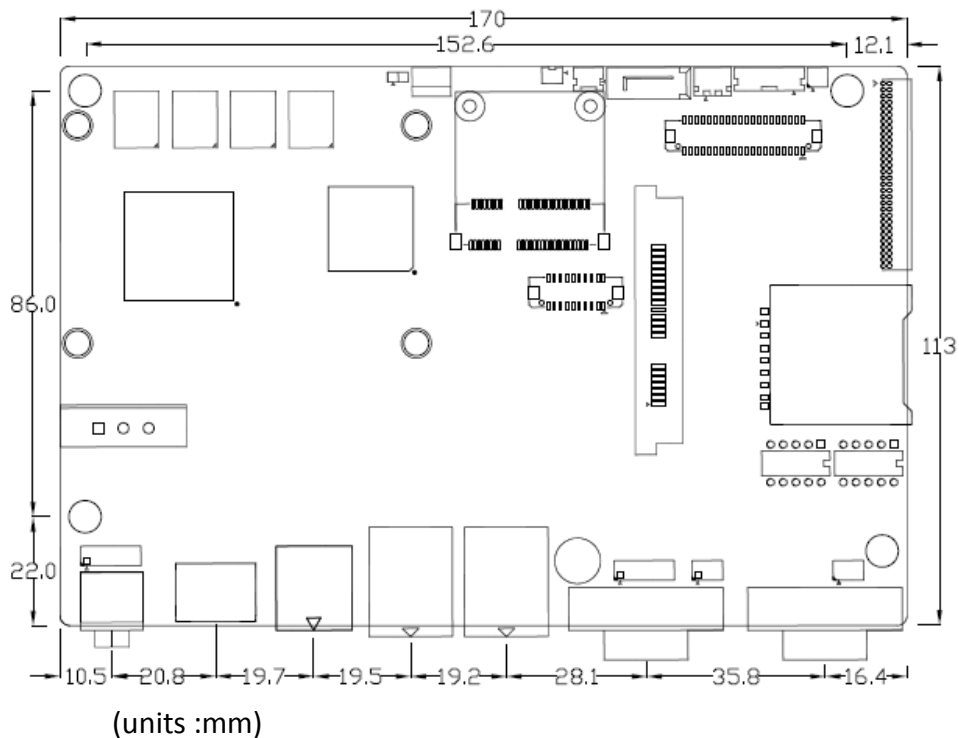

Figure 2.1: Mainboard Dimensions

2.2.1 Jumpers Setting and Connectors

Board Top

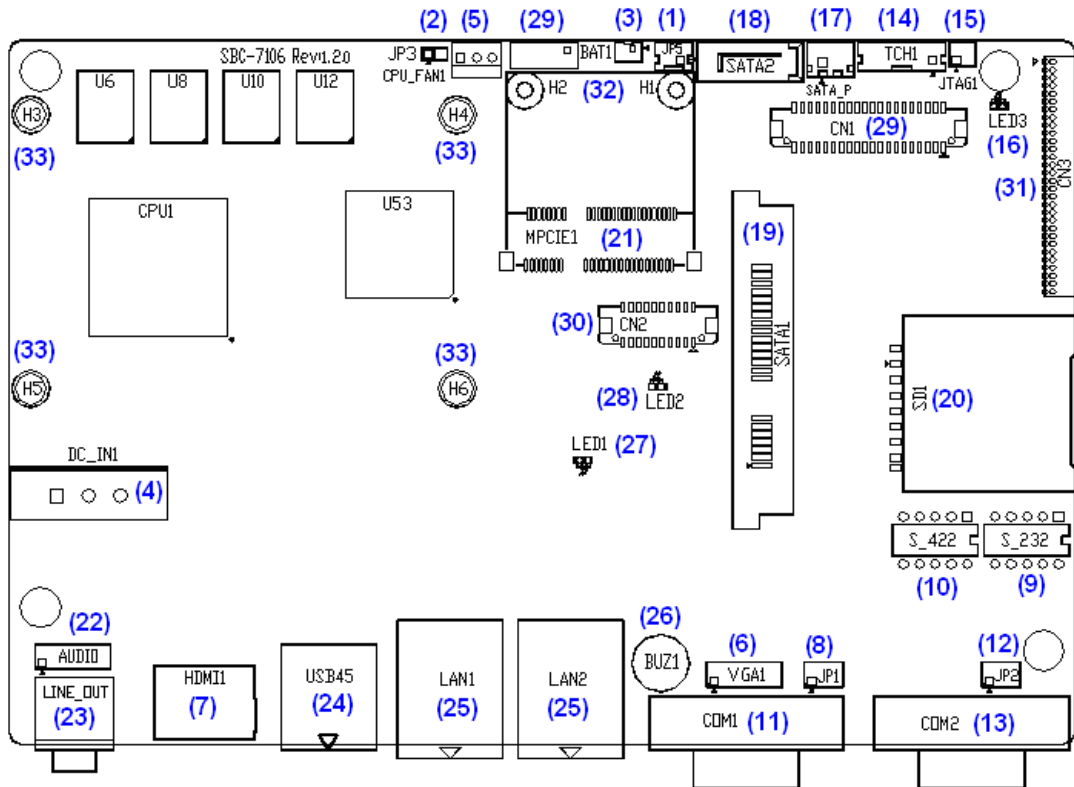

Figure 2.2: Jumpers and Connectors Location_ Board Top

Board Bottom

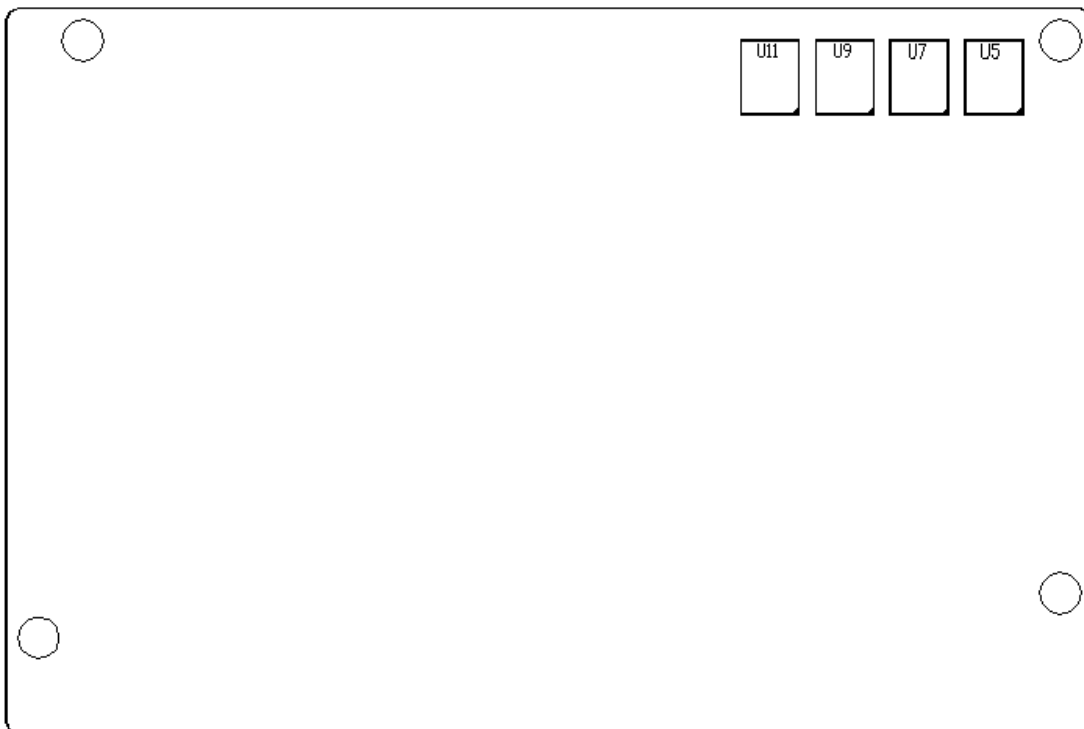

Figure 2.3: Jumpers and Connectors Location_ Board Bottom

2.3 Jumpers Setting and Connectors

1. JP5:

(2.0mm Pitch 1X2 box Pin Header),ATX Power and Auto Power on jumper setting.

JP5	Mode
Open	ATX Power
Close	Auto Power on (Default)

2. JP3:

(2.0mm Pitch 1X2 Pin Header)CMOS clear jumper, CMOS clear operation will permanently reset old BIOS settings to factory defaults.

JP3	CMOS
Open	NORMAL (Default)
Close 1-2	Clear CMOS



Procedures of CMOS clear:

- Turn off the system and unplug the power cord from the power outlet.
- To clear the CMOS settings, use the jumper cap to close pins 1 and 2 for about 3 seconds then reinstall the jumper clip back to pins open.
- Power on the system again.
- When entering the POST screen, press the <F1> or key to enter CMOS Setup Utility to load optimal defaults.
- After the above operations, save changes and exit BIOS Setup.

Model	JP3
SBC-7106-N2600	No
SBC-7106-N2600-P	No
SBC-7106-D2550	Yes

3. BAT1 :

(1.25mm Pitch 1X2 box Pin Header) 3.0V Li battery is embedded to provide power for CMOS.

Pin#	Signal Name
Pin1	VBAT
PIN2	Ground

4. DC_IN1:

(5.08mm Pitch 1x3 Pin Connector),DC9V~32V System power input connector.

Pin#	Power Input
Pin1	DC+9V~32V
Pin2	Ground
Pin3	FG

Model	DC_IN1
SBC-7106-N2600	180°Connector
SBC-7106-N2600-P	45°Connector
SBC-7106-D2550	45°Connector

5. CPU_FAN1:

(2.54mm Pitch 1x3 Pin Header), Fan connector, cooling fans can be connected directly for use. You may set the rotation condition of cooling fan in menu of BIOS CMOS Setup.



Pin#	Signal Name
1	Ground
2	VCC
3	Rotation detection



Note:

Output power of cooling fan must be limited under 5W.

Model	CPU_FAN1
SBC-7106-N2600	No
SBC-7106-N2600-P	No
SBC-7106-D2550	Yes

6 VGA1:

(CRT 2.0mm Pitch 2X6 Pin Header), Video Graphic Array Port, Provide 2x6Pin cable to VGA Port.

Signal Name	Pin#	Pin#	Signal Name
CRT_RED	1	2	Ground
CRT_GREEN	3	4	Ground
CRT_BLUE	5	6	VGA_EN
CRT_H_SYNC	7	8	CRT_DDCCDATA
CRT_V_SYNC	9	10	CRT_DDCCCLK
Ground	11	12	Ground

VGA hot plug setting for Windows XP:	
VGA1 (Pin Header)	Function
Pin4-Pin6 (Close)	VGA Simulation Disabled
Pin4-Pin6 (Open)	VGA Simulation Enabled
use the 2.0mm jumper cap to close pin 4 and pin6	

7 HDMI1:

(HDMI 19P Connector), High Definition Multimedia Interface connector.

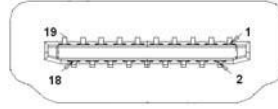

8. JP1:

(2.0mm Pitch 2x3 Pin Header), COM1 jumper setting, pin 1~6 are used to select signal out of pin 9 of COM1 port.

JP1 Pin#	Function
Close 1-2	COM1 RI (Ring Indicator) (default)
Close 3-4	COM1 Pin9=+5V (option)
Close 5-6	COM1 Pin9=+12V (option)

9. S_232:

(Switch), COM1 jumper setting, it provides selectable RS232 or RS422 or RS485 serial signal output.

Function	S_232 Pin#
RS232 (Default)	ON: Pin1, Pin2, Pin3, Pin4
RS422 (option)	OFF: Pin1, Pin2, Pin3, Pin4
RS485 (option)	OFF: Pin1, Pin2, Pin3, Pin4



Note:

How to reach the switch position?

Step 1: Unscrew the storage cover



Step 2: Remove the storage cover

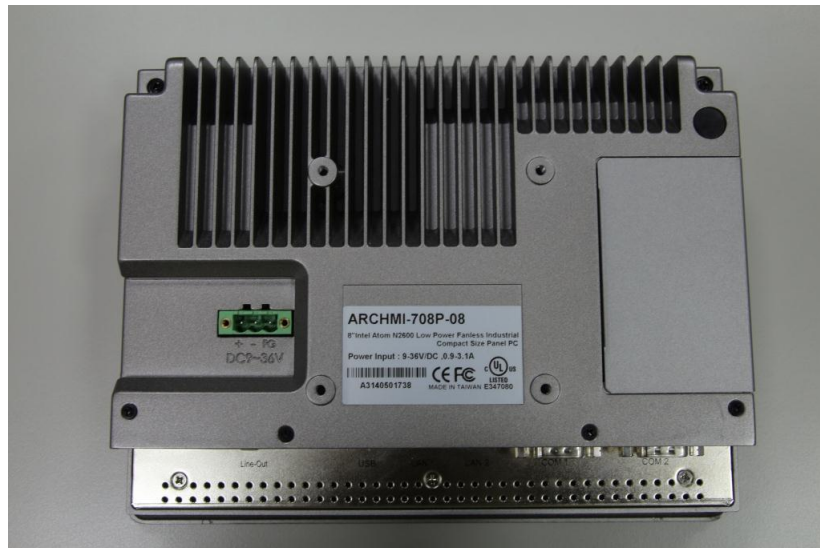

Step 3: Unscrew the storage tray

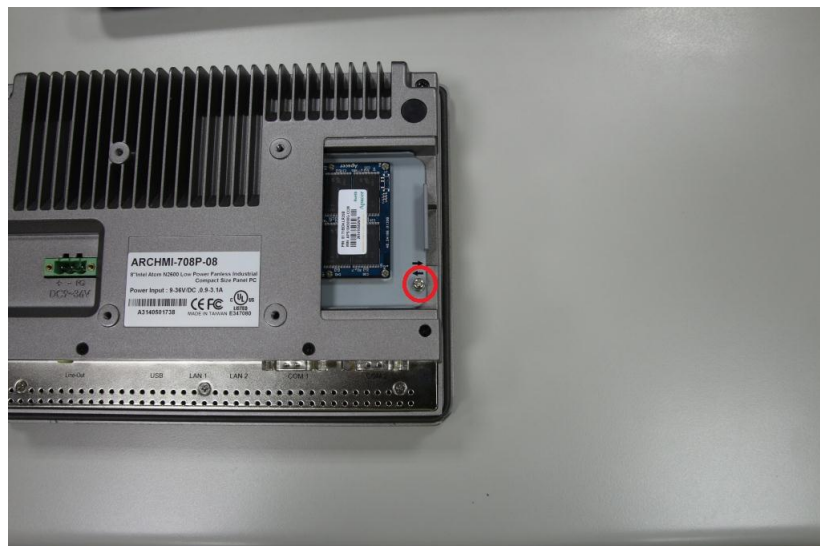

Step 4: Remove the storage tray



Step 5: The function switch setting shows up



10. S_422:

(Switch), COM1 setting, it provides selectable RS232 or RS422 or RS485 serial signal output.

Function	S_422
RS232 (Default)	OFF: Pin1, Pin2, Pin3, Pin4
RS422 (option)	ON: Pin1, Pin2, Pin3, Pin4
RS485 (option)	ON: Pin1, Pin2, Pin3, Pin4

11. COM1:

(Type DB9),Rear serial port, standard DB9 Male serial port is provided to make a direct connection to serial devices. COM1 port is controlled by pins No.1~6 of JP1, select output Signal RI or 5V or 12V, For details, please refer to description of JP1 and S_232 and S_422 setting.

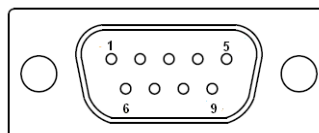

RS232 (Default):	
Pin#	Signal Name
1	DCD# (Data Carrier Detect)
2	RXD (Received Data)
3	TXD (Transmit Data)
4	DTR (Data Terminal Ready)
5	Ground
6	DSR (Data Set Ready)
7	RTS (Request To Send)
8	CTS (Clear To Send)
9	JP1 select Setting (RI/5V/12V)

BIOS Setup:
Advanced/W83627UHG Super IO Configuration/Serial Port
1 Configuration 【RS-232】

RS422 (option):	
Pin#	Signal Name
1	422_RX+
2	422_RX-
3	422_TX-
4	422_TX+
5	Ground
6	NC
7	NC
8	NC
9	NC

BIOS Setup:
Advanced/W83627UHG Super IO Configuration/Serial Port
1 Configuration 【RS-422】

RS485 (option):	
Pin#	Signal Name
1	NC
2	NC
3	485-
4	485+
5	Ground
6	NC
7	NC
8	NC
9	NC

BIOS Setup:
Advanced/W83627UHG Super IO Configuration/Serial Port
1 Configuration 【RS-485】

12. JP2:

(2.0mm Pitch 2x3 Pin Header), COM2 jumper setting, pin 1~6 are used to select signal out of pin 9 of COM2 port.

JP2 Pin#	Function
Close 1-2	COM2 RI (Ring Indicator) (default)
Close 3-4	COM2 Pin9=+5V (option)
Close 5-6	COM2 Pin9=+12V (option)

13. COM2:

(Type DB9), Rear serial port, standard DB9 Male serial port is provided to make a direct connection to serial devices.

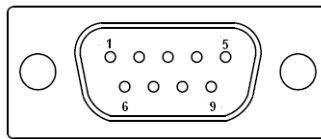

Pin#	Signal Name
1	DCD# (Data Carrier Detect)
2	RXD (Received Data)
3	TXD (Transmit Data)
4	DTR (Data Terminal Ready)
5	Ground
6	DSR (Data Set Ready)
7	RTS (Request To Send)
8	CTS (Clear To Send)
9	RI (Ring Indicator)

14. TCH1:

(2.0mm Pitch 1x6 box Pin Header), internal Touch controller connector.

Pin#	Signal Name
1	SENSE
2	X+
3	X-
4	Y+
5	Y-
6	GND_EARCH

15. JTAG1(option):

(2.0mm Pitch 2x2 Pin Header), Touch eeprom program to write interface

Signal Name	Pin#		Signal Name
3.3V	1	2	C2D_BR
YC2CK_RST	3	4	Ground

16. LED3:

LED STATUS. Green LED for Touch Power status.

17. SATA_P:

(2.5mm Pitch 1x2 box Pin Header), Two onboard 5V output connectors are reserved to provide power for SATA devices.

Pin#	Signal Name
------	-------------

1	+DC5V
2	Ground



Note:

Output current of the connector must not be above 1A.

18. SATA2:

(SATA 7Pin), SATA Connectors, one SATA connectors are provided, with transfer speed up to 3.0Gb/s.

19. SATA1:

(SATA 7Pin+15Pin), SATA Connectors, one SATA connectors are provided, with transfer speed up to 3.0Gb/s.

20. SD1:

(SD card socket), Secure Digital Memory Card socket.

21. MPCIE1:

(Socket 52Pin), mini PCIe socket, it is located at the top, it supports mini PCIe devices with USB2.0 and LPC and SMBUS and PCIe signal. MPCie card size is 30x30mm.

22. AUDIO:

(2.0mm Pitch 2X6 Pin Header), Front Audio, An onboard Realtek ALC662 codec is used to provide high-quality audio I/O ports. Line Out can be connected to a headphone or amplifier. Line In is used for the connection of external audio source via a Line in cable. MIC is the port for microphone input audio.

Signal Name	Pin#	Pin#	Signal Name
5V	1	2	GND_AUD
LINE-OUT-L	3	4	LINE-OUT-R
FRONT_JD	5	6	LINE1_JD
LINE-IN-L	7	8	LINE-IN-R
MIC-IN-L	9	10	MIC-IN-R
GND_AUD	11	12	MIC1_JD

23. LINE_OUT:

(Diameter 3.5mm Jack), HD Audio port, An onboard Realtek ALC662 codec is used to provide high quality audio I/O ports. Line Out can be connected to a headphone or amplifier.

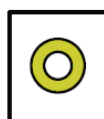

Line out

24. USB45:

USB4/USB5: (Double stack USB type A), Rear USB connector, it provides up to 4 USB2.0 ports,

High-speed USB 2.0 allows data transfers up to 480 Mb/s, support USB full-speed and low-speed signaling.

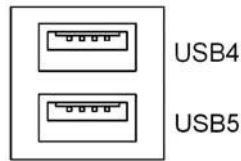

Each USB Type A Receptacle (2 Ports) Current limited value is 1.5A.

If the external USB device current exceeds 1.5A, please separate connectors into different Receptacle.

25. LAN1/LAN2:

LAN1/LAN2: (RJ45 Connector), Rear LAN port, Two standard 10/100/1000M RJ-45 Ethernet ports are provided. Used Realtek RTL8111E chipset, LINK LED (green) and ACTIVE LED (yellow) respectively located at the left-hand and right-hand side of the Ethernet port indicate the activity and transmission state of LAN.

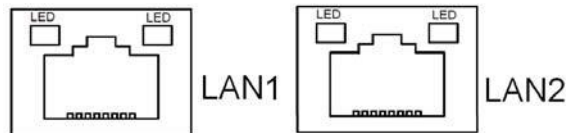

26. BUZ1:

Onboard buzzer.

27. LED1:

LED STATUS. Green LED for Motherboard Power status.

28. LED2:

LED STATUS. Green LED for Motherboard Standby Power Good status.

29. CN1:

(DF13-40P Connector), For expand output connector, It provides one 18/24bit single channel LVDS, one Backlight control, two USB ports, one power led, one HDD LED, one power on/off button, one RESET.

Function	Signal Name	Pin#		Signal Name	Function
LVDS	12V_S0	2	1	12V_S0	LVDS
	BKLT_EN_OUT	4	3	BKLT_CTRL	
	Ground	6	5	Ground	
	LVDS_VDD5	8	7	LVDS_VDD5	
	LVDS_VDD3	10	9	LVDS_VDD3	
	Ground	12	11	Ground	
	LA_DATAP0	14	13	LA_DATAN0	
	LA_DATAP1	16	15	LA_DATAN1	
	LA_DATAP2	18	17	LA_DATAN2	
	LA_DATAP3	20	19	LA_DATAN3	

	LA_CLKP	22	21	LA_CLKN	
	Ground	24	23	Ground	
	Ground	26	25	Ground	
USB1	USB1_P	28	27	USB1_N	USB1
USB0	USB0_P	30	29	USB0_N	USB0
	5V_USB01	32	31	5V_USB01	USB1
	5V_USB01	34	33	5V_USB01	
PWR LED	PWR_LED+	36	35	HDD_LED+	HDD LED
	Ground	38	37	Ground	
PWR ON/OFF	PWRBTN_ON-	40	39	FP_RST-	RESET

INVT1:

(2.0mm Pitch 1x6 Pin wafer connector), Backlight control connector for LVDS.

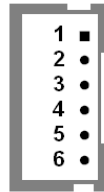

Pin#	Signal Name
1	+DC12V
2	+DC12V
3	Ground
4	Ground
5	BKLT_EN_OUT
6	BKLT_CTRL



Note:

Pin6 is backlight control signal, support DC or PWM mode, mode select at BIOS CMOS menu.

30. CN2:

(DF13-20P Connector), for expand output connector, it provides eight GPIO, one RS422 or RS485.

Function	Signal Name	Pin#		Signal Name	Function
5V	5V_S5	2	1	5V_S5	5V
SIO_GPIO61	GPIO_IN2	4	3	GPIO_IN1	SIO_GPIO60
SIO_GPIO63	GPIO_IN4	6	5	GPIO_IN3	SIO_GPIO62
	Ground	8	7	Ground	
SIO_GPIO21	GPIO_OUT2	10	9	GPIO_OUT1	SIO_GPIO20
SIO_GPIO23	GPIO_OUT4	12	11	GPIO_OUT3	SIO_GPIO22
	Ground	14	13	Ground	
485 or 422	485+_422TX+	16	15	485-_422TX-	485 or 422
RS422	422_RX+	18	17	422_RX-	RS422
5V	5V_S0	20	19	5V_S0	5V

COM3 BIOS Setup:

Advanced/W83627UHG Super IO Configuration/Serial Port 3 Configuration

【RS-422】

Advanced/W83627UHG Super IO Configuration/Serial Port 3 Configuration

【RS-485】

31. CN3:

(1.27mm Pitch 2X30 Pin Header), For expand output connector, It provides four GPIO, Two USB 2.0, one PS/2 mouse, one PS/2 keyboard, two uart, one PCIe x1, one SMBus. connected to the TB-528 riser Card.

Function	Signal Name	Pin#		Signal Name	Function
	5V_S5_USB	1	2	5V_S5_USB	
	5V_S5_USB	3	4	5V_S5_USB	
	USB23_OC	5	6	CLKREQPSON_ATX-	
USB2	USB2_N	7	8	USB2_P	USB2
USB3	USB3_N	9	10	USB3_P	USB3
	Ground	11	12	Ground	
PS/2 MS	PS2_MSCLK	13	14	PS2_MSDATA	PS/2 MS
PS/2 KB	PS2_KBCLK	15	16	PS2_KBDATA	PS/2 KB
COM6 (UART)	COM6_RI	17	18	COM6_DCD-	COM6 (UART)
	COM6_TXD	19	20	COM6_RXD	
	COM6_DTR	21	22	RICOM6_RTS-	
	COM6_DSR	23	24	COM6_CTS-	
	Ground	25	26	Ground	
COM5 (UART)	COM5_RI	27	28	COM5_DCD-	COM5 (UART)
	COM5_TXD	29	30	COM5_RXD	
	COM5_DTR	31	32	DSRCOM5_RTS-	
	COM5_DSR	33	34	DTRCOM5_CTS-	
GPIO24	ICH_GPIO24	35	36	ICH_GPIO13	GPIO13
GPIO26	ICH_GPIO26	37	38	ICH_GPIO27	GPIO27
	Ground	39	40	Ground	
PCIE	PE1_TX_N0	41	42	PE1_TX_P0	PCIE
	PE1_RX_N0	43	44	PE1_RX_P0	
	Ground	45	46	Ground	
	CLK_100M_PE1_N	47	48	CLK_100M_PE1_P	
	PM_PCIE_WAKE	49	50	PLTRST_BUF-	
SMBUS	SMB_CLK_S5	51	52	SMB_DATA_S5	SMBUS
PCIE	PE1_CLKREQ	53	54	Ground	
	3P3V_S5	55	56	PWRBTN_ON-	
	3P3V_S5	57	58	3P3V_S5	
12V	12V_S0	59	60	12V_S0	12V

32. H3/H4/H5/H6:

CPU1 and U53 Heat Sink SCREW HOLES, Four screw holes for intel N2600 and NM10 Heat Sink assemble.

33. H1/H2:

MPCIE1 SCREW HOLES, H1and H2 for mini PCIE card (30mmx30mm) assemble.

34. TB-528C2ME1 (option) :

SBC-7106 Riser Card,TB-528C2ME1 CN3 connect to SBC-7106 CN3 pin Header.

TB-528C2ME1 Top:

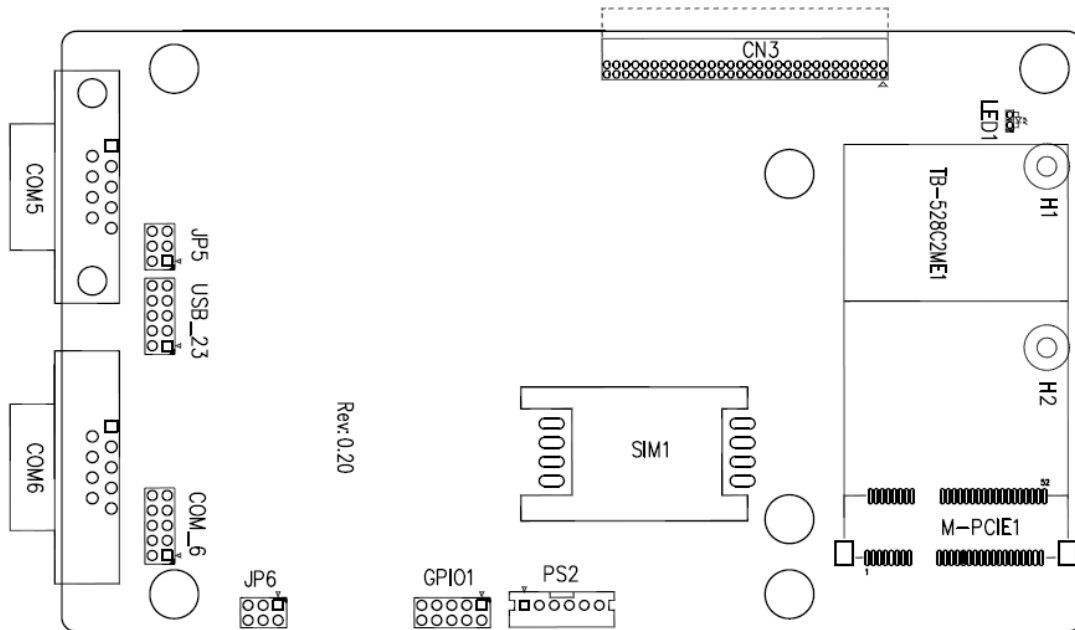

CN3:

(1.27mm Pitch 2X30 Pin Header),connect to SBC-7106 CN3 pin Header.

M-PCIE1:

(Socket 52Pin),mini PCIe socket, it is located at the top, it supports mini PCIe devices with **USB2.0(USB2)**,Smbus,SIM and PCIe signal. MPCIE card size is 30x30mm or 30x50.95mm.

Signal Name	Function support
PCIe 1X	Yes
USB2.0 (USB2)	Yes
SMBus	Yes
SIM	Yes

H1/H2:

MPCIE1 SCREW HOLES, H2 for mini PCIE card (30mmx30mm) assemble. H1 for mini PCIE card (30mmx50.95mm) assemble.

LED1:

Mini PCIe devices LED Status.

SIM1:

(SIM Socket 6 Pin), Support SIM Card devices.

PS2:

(2.0mm Pitch 1X6 Pin Wafer), PS/2 keyboard and mouse port, the port can be connected to PS/2 keyboard or mouse via a dedicated cable for direct used.

Pin#	Signal Name
1	KBDATA
2	MSDATA
3	Ground
4	+5V
5	KBCLK
6	MSCLK

GPIO1:

(2.0mm Pitch 2x5 Pin Header),General-purpose input/output port, it provides a group of self-programming interfaces to customers for flexible use.

Signal Name	Pin#	Pin#	Signal Name
Ground	1	2	NC
NC	3	4	SMB_DATA_R
SMB_CLK_R	5	6	ICH_GPIO13_IN1
ICH_GPIO24_IN2	7	8	ICH_GPIO26_IN3
ICH_GPIO27_IN4	9	10	+5V

USB_23:

(2.0mm Pitch 2x5 Pin Header) ,Front USB connector, it provides one USB port via a dedicated USB cable, speed up to 480Mb/s.

Signal Name	Pin#	Pin#	Signal Name
5V_USB23	1	2	5V_USB23
USB3_N	3	4	USB2_N (option, NC)
USB3_P	5	6	USB2_P (option, NC)
Ground	7	8	Ground
NC	9	10	Ground



Note:

Before connection, make sure that pinout of the USB Cable is in accordance with that of the said tables. Any inconformity may cause system down and even hardware damages.

JP5:

(2.0mm Pitch 2x3 Pin Header),COM5 setting jumper, pin 1~6 are used to select signal out of pin 9 of COM5 port.

JP5 Pin#	Function
Close 1-2	RI (Ring Indicator) (default)
Close 3-4	COM5 Pin9=+5V (option)
Close 5-6	COM5 Pin9=+12V (option)

COM5:

(Type DB9), serial port, standard DB9 serial port is provided to make a direct connection to serial devices. COM5 port is controlled by pins No.1~6 of **JP5**, select output Signal RI or 5V or 12v, For details, please refer to description of JP3.

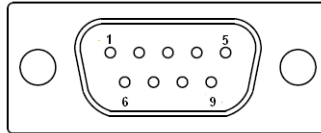

Pin#	Signal Name
1	DCD# (Data Carrier Detect)
2	RXD (Received Data)
3	TXD (Transmit Data)
4	DTR (Data Terminal Ready)
5	Ground
6	DSR (Data Set Ready)
7	RTS (Request To Send)
8	CTS (Clear To Send)
9	JP5 Setting: Pin1-2 : RI (Ring Indicator) (default) Pin3-4 : 5V Standby power (option) Pin5-6:12V Standby power (option)

JP6:

(2.0mm Pitch 2x3 Pin Header), COM6 setting jumper, pin 1~6 are used to select signal out of pin 9 of COM6 port.

JP6 Pin#	Function
Close 1-2	RI (Ring Indicator) (default)
Close 3-4	COM6 Pin9=+5V (option)
Close 5-6	COM6 Pin9=+12V (option)

COM6:

(Type DB9), serial port, standard DB9 serial port is provided to make a direct connection to serial devices. COM6 port is controlled by pins No.1~6 of **JP6**, select output Signal RI or 5V or 12v, For details, please refer to description of JP6.

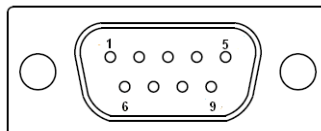

Pin#	Signal Name
1	DCD# (Data Carrier Detect)
2	RXD (Received Data)
3	TXD (Transmit Data)
4	DTR (Data Terminal Ready)
5	Ground
6	DSR (Data Set Ready)
7	RTS (Request To Send)
8	CTS (Clear To Send)
9	JP6 Setting: Pin1-2 : RI (Ring Indicator) (default) Pin3-4 : 5V Standby power (option) Pin5-6:12V Standby power (option)

COM_6 (option) :

(2.0mm Pitch 2X5 Pin Header),COM6 Port, up to one standard RS232 port are provided. They can be used directly via COM cable connection.

Signal Name	Pin#	Pin#	Signal Name
DCD	1	2	RXD
TXD	3	4	DTR
Ground	5	6	DSR
RTS	7	8	CTS
JP6 Setting: RI/5V/12V	9	10	NC

35. TB-528C2 (option) :

SBC-7106 Riser Card,TB-528C2ME1 CN3 connect to SBC-7106 CN3 pin Header.
TB-528C2ME1 Top:

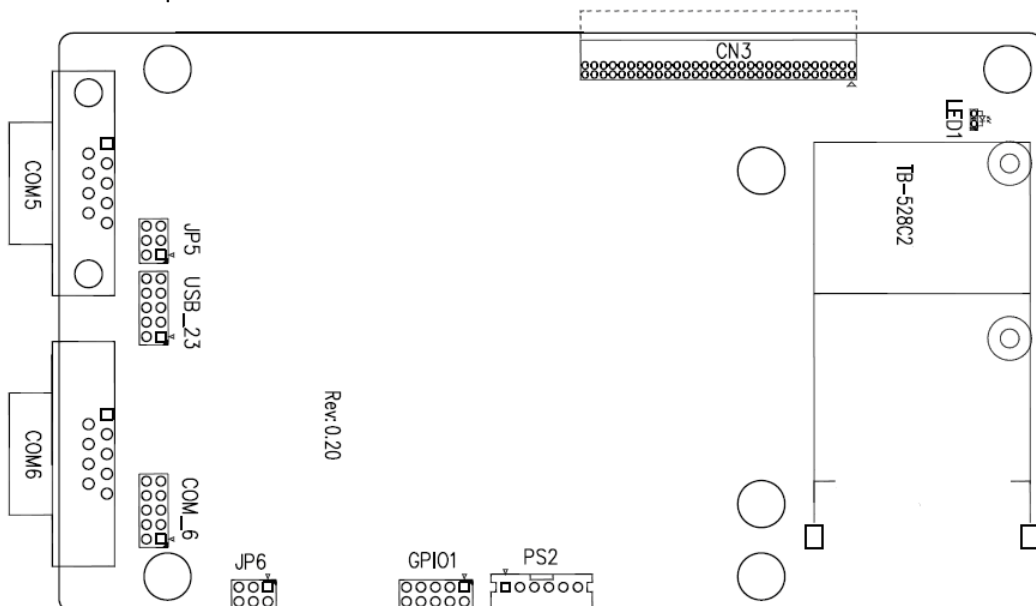

CN3:

(1.27mm Pitch 2X30 Pin Header), connect to SBC-7106 CN3 pin Header.

LED1:

Mini PCIe devices LED Status.

PS2:

(2.0mm Pitch 1X6 Pin Wafer), PS/2 keyboard and mouse port, the port can be connected to PS/2 keyboard or mouse via a dedicated cable for direct used.

Pin#	Signal Name
1	KBDATA
2	MSDATA
3	Ground
4	+5V
5	KBCLK
6	MSCLK

GPIO1:

(2.0mm Pitch 2x5 Pin Header), General-purpose input/output port, it provides a group of self-programming interfaces to customers for flexible use.

Signal Name	Pin#	Pin#	Signal Name
Ground	1	2	NC
NC	3	4	SMB_DATA_R
SMB_CLK_R	5	6	ICH_GPIO13_IN1
ICH_GPIO24_IN2	7	8	ICH_GPIO26_IN3
ICH_GPIO27_IN4	9	10	+5V

USB_23:

(2.0mm Pitch 2x5 Pin Header) ,Front USB connector, it provides one USB port via a dedicated USB cable, speed up to 480Mb/s.

Signal Name	Pin#	Pin#	Signal Name
5V_USB23	1	2	5V_USB23
USB3_N	3	4	USB2_N
USB3_P	5	6	USB2_P
Ground	7	8	Ground
NC	9	10	Ground



Note:

Before connection, make sure that pinout of the USB Cable is in accordance with that of the said tables. Any inconformity may cause system down and even hardware damages.

JP5:

(2.0mm Pitch 2x3 Pin Header), COM5 setting jumper, pin 1~6 are used to select signal out of pin 9 of COM5 port.

JP5 Pin#	Function
Close 1-2	RI (Ring Indicator) (default)
Close 3-4	COM5 Pin9=+5V (option)
Close 5-6	COM5 Pin9=+12V (option)

COM5:

(Type DB9), serial port, standard DB9 serial port is provided to make a direct connection to serial devices. COM5 port is controlled by pins No.1~6 of **JP5**, select output Signal RI or 5V or 12v, for details, please refer to description of JP3.

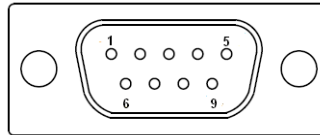

Pin#	Signal Name
1	DCD# (Data Carrier Detect)
2	RXD (Received Data)
3	TXD (Transmit Data)
4	DTR (Data Terminal Ready)
5	Ground
6	DSR (Data Set Ready)
7	RTS (Request To Send)
8	CTS (Clear To Send)
9	JP5 Setting: Pin1-2 : RI (Ring Indicator) (default) Pin3-4 : 5V Standby power (option) Pin5-6:12V Standby power (option)

JP6

(2.0mm Pitch 2x3 Pin Header), COM6 setting jumper, pin 1~6 are used to select signal out of pin 9 of COM6 port.

JP6 Pin#	Function
Close 1-2	RI (Ring Indicator) (default)
Close 3-4	COM6 Pin9=+5V (option)
Close 5-6	COM6 Pin9=+12V (option)

COM6:

(Type DB9), serial port, standard DB9 serial port is provided to make a direct connection to serial devices. COM6 port is controlled by pins No.1~6 of **JP6**, select output Signal RI or 5V or 12v, for details, please refer to description of JP6.

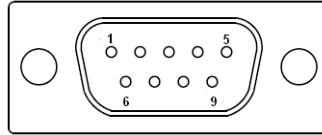

Pin#	Signal Name
1	DCD# (Data Carrier Detect)
2	RXD (Received Data)
3	TXD (Transmit Data)
4	DTR (Data Terminal Ready)
5	Ground
6	DSR (Data Set Ready)
7	RTS (Request To Send)
8	CTS (Clear To Send)
9	JP6 Setting: Pin1-2 : RI (Ring Indicator) (default) Pin3-4 : 5V Standby power (option) Pin5-6:12V Standby power (option)

COM_6 (option) :

(2.0mm Pitch 2X5 Pin Header), COM6 Port, up to one standard RS232 port are provided. They can be used directly via COM cable connection.

Signal Name	Pin#	Pin#	Signal Name
DCD	1	2	RXD
TXD	3	4	DTR
Ground	5	6	DSR
RTS	7	8	CTS
JP6 Setting: RI/5V/12V	9	10	NC

36. TB-528C1U2P1 (option) :

SBC-7106 Riser Card, TB-528C1U2P1 CN3 connect to SBC-7106 CN3 pin Header.

TB-528C1U2P1 Top:

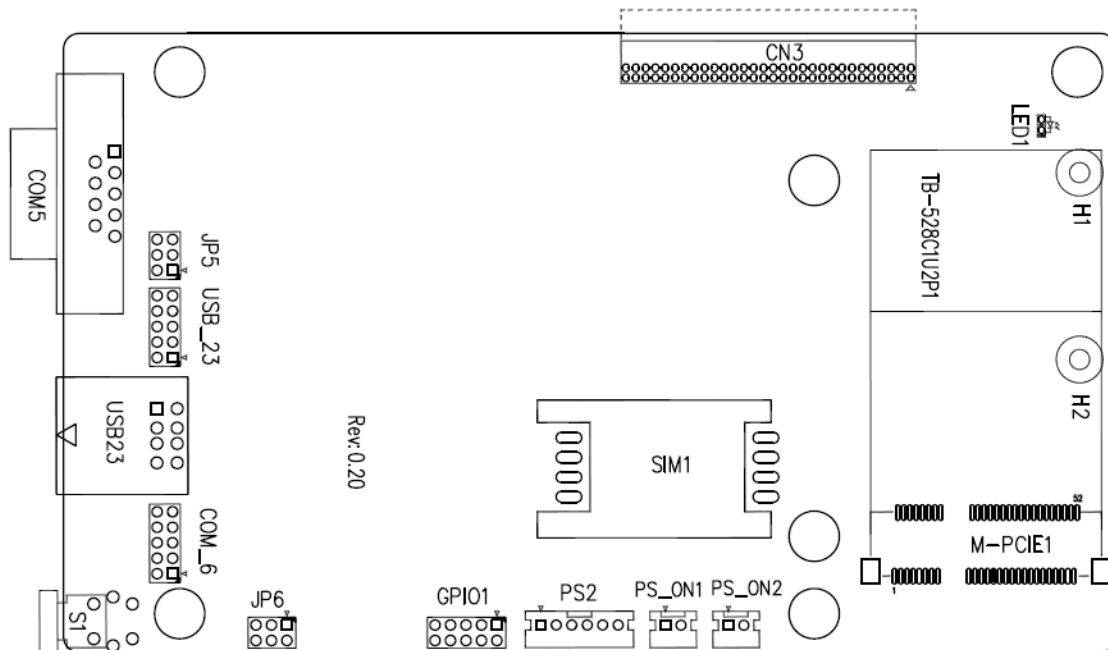

CN3:

(1.27mm Pitch 2X30 Pin Header), connect to SBC-7106 CN3 pin Header.

M-PCIE1:

(Socket 52Pin), mini PCIe socket, it is located at the top, it supports mini PCIe devices with Smbus, SIM and PCIe signal. MPCle card size is 30x30mm or 30x50.95mm.

Signal Name	Function support
PCIe 1X	Yes
USB2.0 (USB2)	NC (option)
SMBus	Yes
SIM	Yes

H1/H2:

MPCIE1 SCREW HOLES, H2 for mini PCIE card (30mmx30mm) assemble. H1 for mini PCIE card (30mmx50.95mm) assemble.

LED1:

Mini PCIe devices LED Status.

SIM1 (option) :

(SIM Socket 6 Pin), Support SIM Card devices.

PS_ON1:

(2.0mm Pitch 1X2 Pin Wafer), ATX Power and Auto Power on jumper setting.

PS_ON	Mode
Close 1-2	Auto Power on (Default)
Open 1-2	ATX Power

PS_ON2 (option) :

(2.0mm Pitch 1X2 Pin Wafer), They can be used directly via cable connection to SBC-7106 JP5.

PS_ON2	SBC-7106 R1.10 /JP5
Pin1	Pin1
Pin2	Pin2

PS2:

(2.0mm Pitch 1X6 Pin Wafer), PS/2 keyboard and mouse port, the port can be connected to PS/2 keyboard or mouse via a dedicated cable for direct used.

Pin#	Signal Name
1	KBDATA
2	MSDATA
3	Ground
4	+5V
5	KBCLK
6	MSCLK

GPIO1:

(2.0mm Pitch 2x5 Pin Header), General-purpose input/output port, it provides a group of self-programming interfaces to customers for flexible use.

Signal Name	Pin#	Pin#	Signal Name
Ground	1	2	NC
NC	3	4	SMB_DATA_R
SMB_CLK_R	5	6	ICH_GPIO13_IN1
ICH_GPIO24_IN2	7	8	ICH_GPIO26_IN3
ICH_GPIO27_IN4	9	10	+5V

USB23:

(Double stack USB type A), Rear USB connector, it provides up to 2 USB2.0 ports, speed up to 480Mb/s.

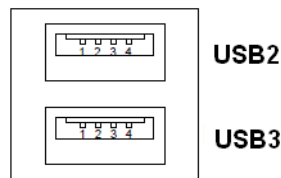

USB_23 (option) :

(2.0mm Pitch 2x5 Pin Header) ,Front USB connector, it provides one USB port via a dedicated USB cable, speed up to 480Mb/s.

Signal Name	Pin#	Pin#	Signal Name
5V_USB23	1	2	5V_USB23
USB3_N	3	4	USB2_N
USB3_P	5	6	USB2_P
Ground	7	8	Ground
NC	9	10	Ground



Note:

Before connection, make sure that pinout of the USB Cable is in accordance with that of the said tables. Any inconformity may cause system down and even hardware damages.

JP5:

(2.0mm Pitch 2x3 Pin Header), COM5 setting jumper, pin 1~6 are used to select signal out of pin 9 of COM5 port.

JP3 Pin#	Function
Close 1-2	RI (Ring Indicator) (default)
Close 3-4	COM5 Pin9=+5V (option)
Close 5-6	COM5 Pin9=+12V (option)

COM5:

(Type DB9), serial port, standard DB9 serial port is provided to make a direct connection to serial devices. COM5 port is controlled by pins No.1~6 of **JP5**,select output Signal RI or 5V or 12v, for details, please refer to description of JP3.

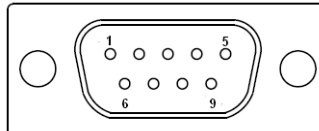

Pin#	Signal Name
1	DCD# (Data Carrier Detect)
2	RXD (Received Data)
3	TXD (Transmit Data)
4	DTR (Data Terminal Ready)
5	Ground
6	DSR (Data Set Ready)
7	RTS (Request To Send)
8	CTS (Clear To Send)
9	JP5 Setting: Pin1-2 : RI (Ring Indicator) (default) Pin3-4 : 5V Standby power (option) Pin5-6:12V Standby power (option)

JP6

(2.0mm Pitch 2x3 Pin Header), COM6 setting jumper, pin 1~6 are used to select signal out of pin 9 of COM6 port.

JP3 Pin#	Function
Close 1-2	RI (Ring Indicator) (default)
Close 3-4	COM6 Pin9=+5V (option)
Close 5-6	COM6 Pin9=+12V (option)

COM6:

(Type DB9), serial port, standard DB9 serial port is provided to make a direct connection to serial devices. COM6 port is controlled by pins No.1~6 of **JP6**, select output Signal RI or 5V or 12v, For details, please refer to description of JP6.

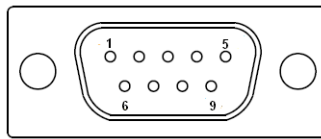

Pin#	Signal Name
1	DCD# (Data Carrier Detect)
2	RXD (Received Data)
3	TXD (Transmit Data)
4	DTR (Data Terminal Ready)
5	Ground
6	DSR (Data Set Ready)
7	RTS (Request To Send)
8	CTS (Clear To Send)
9	JP6 Setting: Pin1-2 : RI (Ring Indicator) (default) Pin3-4 : 5V Standby power (option) Pin5-6:12V Standby power (option)

S1

PWR BT: POWER on/off Button, They are used to connect power switch button. The two pins are disconnected under normal condition. You may short them temporarily to realize system startup & shutdown or awaken the system from sleep state.

PWR LED: POWER LED status.

S1	Model	TB-528C1U2P1	PS_ON2
Yes	SBC-7106 R110	R12/ NC	Cable
Yes	SBC-7106 R120	R12/ 0ohm	NC

37. TB-528CAN2 R0.10 (option) :

SBC-7106 Riser Card, TB-528CAN2 CN3 connect to SBC-7106 CN3 pin Header.

It provides two CAN-bus Interface.

TB-528CAN2 Top:

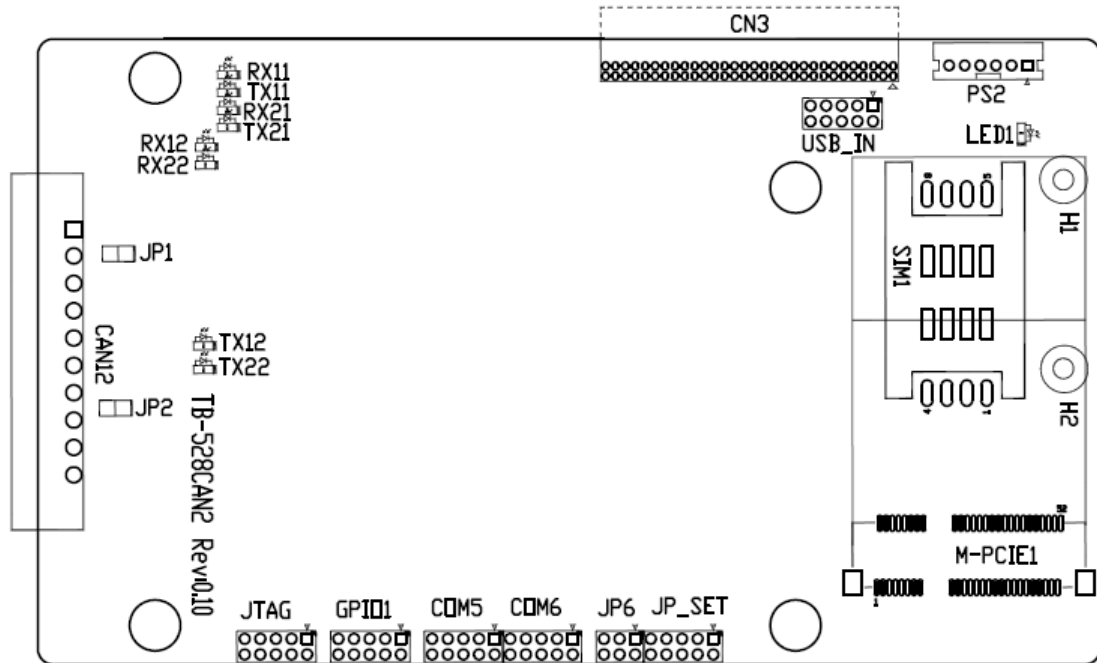

CN3:

(1.27mm Pitch 2X30 Pin Header), connect to SBC-7106 CN3 pin Header.

M-PCIE1:

(Socket 52Pin), mini PCIe socket, it is located at the top, it supports mini PCIe devices with Smbus, USB2.0, SIM and PCIe signal. MPCle card size is 30x30mm or 30x50.95mm.

Signal Name	Function support
PCIe 1X	Yes
USB2.0 (USB2)	Yes
SMBus	Yes
SIM	Yes

H1/H2:

MPCIE1 SCREW HOLES, H2 for mini PCIE card (30mmx30mm) assemble. H1 for mini PCIE card (30mmx50.95mm) assemble.

LED1:

Mini PCIe devices LED Status.

SIM1 (option) :

(SIM Socket 6 Pin), Support SIM Card devices.

PS2:

(2.0mm Pitch 1X6 Pin Wafer), PS/2 keyboard and mouse port, the port can be connected to PS/2 keyboard or mouse via a dedicated cable for direct used.

Pin#	Signal Name
1	KBDATA
2	MSDATA
3	Ground
4	+5V
5	KBCLK
6	MSCLK

USB_IN (option) :

(2.0mm Pitch 2x5 Pin Header) ,Front USB connector, it provides two USB port via a dedicated USB cable, speed up to 480Mb/s.

Signal Name	Pin#	Pin#	Signal Name
5V_USB23	1	2	5V_USB23
NC (USB3_N)	3	4	NC (USB2_N)
NC (USB3_P)	5	6	NC (USB2_P)
Ground	7	8	Ground
NC	9	10	Ground



Note:

Before connection, make sure that pinout of the USB Cable is in accordance with that of the said tables. Any inconformity may cause system down and even hardware damages.

JP_SET (option) :

(2.0mm Pitch 2x5 Pin Header).

Signal Name	Pin#	Pin#	Signal Name
3P3V_S5_USB	1	2	3P3V_S5
3P3V_S5_USB	3	4	3P3V_S5
3P3V_S5_USB	5	6	3P3V_S5
PSON_ATX	7	8	Ground
PSON_ATX	9	10	Ground

JP6:

(2.0mm Pitch 2x3 Pin Header), COM6 setting jumper, pin 1~6 are used to select signal out of pin 9 of COM6 port.

JP3 Pin#	Function
Close 1-2	RI (Ring Indicator) (default)
Close 3-4	COM6 Pin9=+5V (option)
Close 5-6	COM6 Pin9=+12V (option)

COM6:

(2.0mm Pitch 2X5 Pin Header), COM6 Port, up to one standard RS232 port are provided. They can be used directly via COM cable connection.

Signal Name	Pin#	Pin#	Signal Name
DCD	1	2	RXD
TXD	3	4	DTR
Ground	5	6	DSR
RTS	7	8	CTS
JP6 Setting: RI/5V/12V	9	10	NC

COM5:

(2.0mm Pitch 2X5 Pin Header), COM5 Port, up to one standard RS232 port are provided. They can be used directly via COM cable connection.

Signal Name	Pin#	Pin#	Signal Name
DCD	1	2	RXD
TXD	3	4	DTR
Ground	5	6	DSR
RTS	7	8	CTS
RI	9	10	NC

GPIO1:

(2.0mm Pitch 2x5 Pin Header), General-purpose input/output port, it provides a group of self-programming interfaces to customers for flexible use.

Signal Name	Pin#	Pin#	Signal Name
Ground	1	2	NC
NC	3	4	SMB_DATA_R
SMB_CLK_R	5	6	ICH_GPIO13_IN1
ICH_GPIO24_IN2	7	8	ICH_GPIO26_IN3
ICH_GPIO27_IN4	9	10	+5V

JTAG:

(2.0mm Pitch 2x5 Pin Header), Reserve.

JP1:

(2.0mm Pitch 1x2 Pin Header), Reserve.

JP2:

(2.0mm Pitch 1x2 Pin Header), Reserve.

CAN12:

(3.5mm Pitch 1x10 Pin connector), it provides two CAN-bus Interface.

Pin#	Channel	Signal Name	Function
1	CAN2	CANL2	CAN bus Signal L
2		R2-	Terminal resistor R-(internally connected to CANL2)
3		FG	Shield cable (FG)
4		R2+	Terminal resistor R+(internally connected to CANH2)
5		CANH2	CAN bus Signal H
6	CAN1	CANL1	CAN bus Signal L
7		R1-	Terminal resistor R-(internally connected to CANL1)
8		FG	Shield cable (FG)
9		R1+	Terminal resistor R+(internally connected to CANH1)
10		CANH1	CAN bus Signal H

【See TB-528AN2 Manual】

3.1 Operations after POST Screen

After CMOS discharge or BIOS flashing operation, Press [Delete] key to enter CMOS Setup.

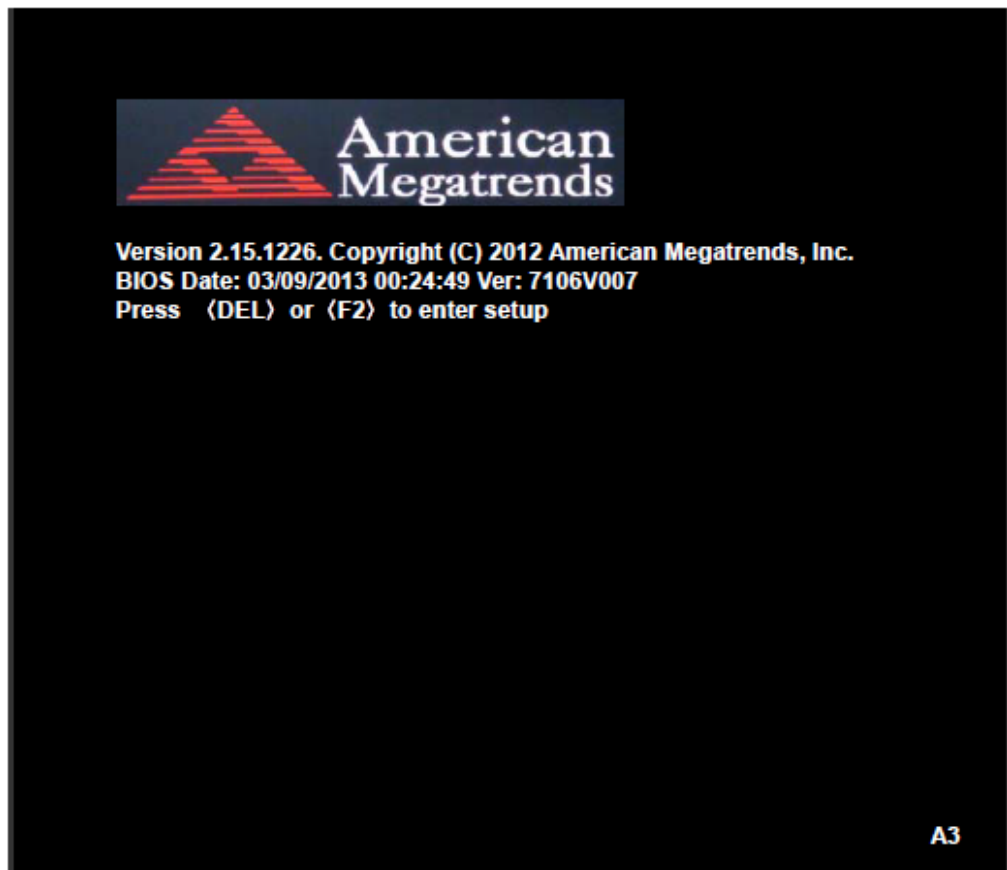

After optimizing and exiting CMOS Setup, the POST screen displayed for the first time is as follows and includes basic information on BIOS, CPU, memory, and storage devices.

3.2 BIOS Setup Utility

Press [Delete] key to enter BIOS Setup utility during POST, and then a main menu containing system summary information will appear.

Aptio Setup Utility – Copyright (C) 2012 American Megatrends, Inc.					
Main	Advanced	Chipset	Boot	Security	Save & Exit
BIOS Information					Intel Reference Code
BIOS Vendor	American Megatrends			Version	
Core Version	4.6.5.3				
Compliance	UEFI 2.3; PI 1.2				
Project Version	7106V007				
Build Date and Time	03/09/2013 00:24:49				
▶ Intel RC Version					
System Language	[English]				→←: Select Screen
System Date	[Sun 01/01/2012]				↑↓ : Select Item
System Time	[00:00:08]				Enter: Select
Access Level	Administrator				+/- : Change Opt.
					F1 : General Help
					F2: Previous Values
					F3:Optimized Defaults
					F4:Save and Exit
					ESC Exit
Version 2.15.1226. Copyright (C) 2012 American Megatrends , Inc.					

3.3 Main Settings

BIOS Information					Intel Reference Code
BIOS Vendor	American Megatrends			Version	
Core Version	4.6.5.3				
Compliance	UEFI 2.3; PI 1.2				
Project Version	7106V007				
Build Date and Time	03/09/2013 00:24:49				
▶ Intel RC Version					
System Language	[English]				→←: Select Screen
System Date	[Sun 01/01/2012]				↑↓ : Select Item
System Time	[00:00:08]				Enter: Select
Access Level	Administrator				+/- : Change Opt.
					F1 : General Help
					F2: Previous Values
					F3:Optimized Defaults
					F4:Save and Exit
					ESC Exit
Version 2.15.1226. Copyright (C) 2012 American Megatrends , Inc.					

System Time:

Set the system time, the time format is:

Hour: 0 to 23

Minute: 0 to 59

Second: 0 to 59

System Date

Set the system date, the date format is:

Day: Note that the 'Day' automatically changes when you set the date.

Month: 01 to 12

Date: 01 to 31

Year: 1998 to 2099

3.4 Advanced Settings

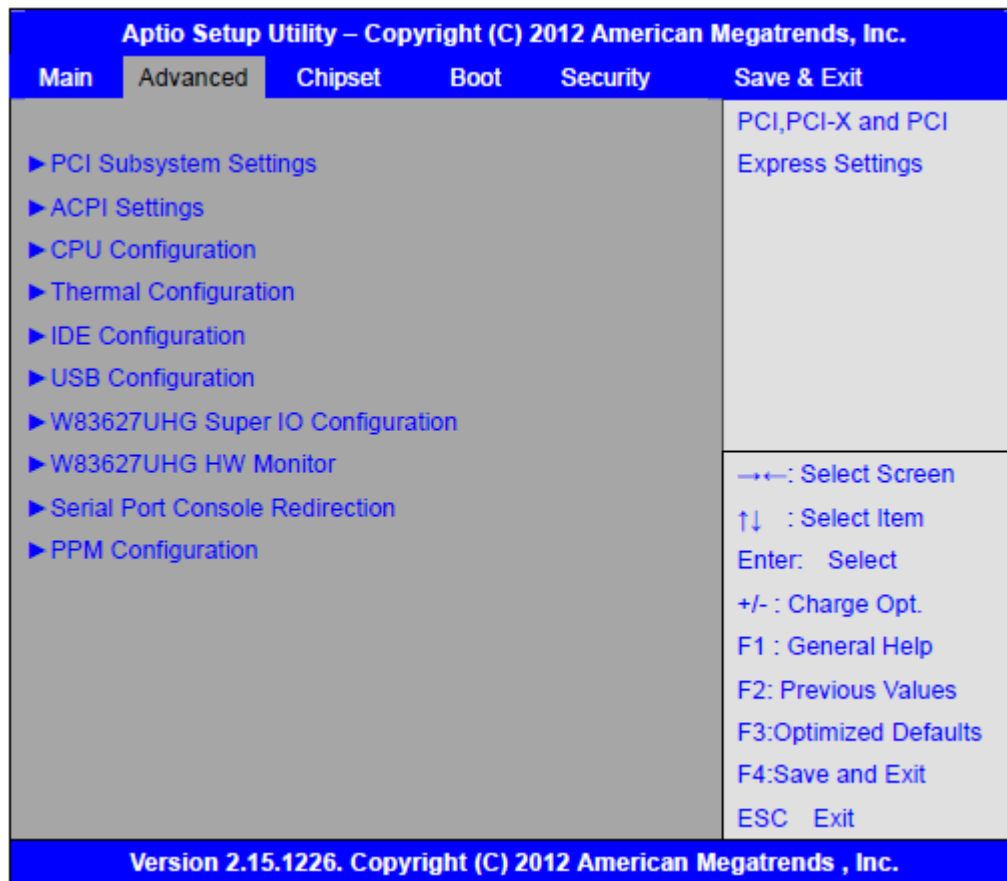

3.4.1 PCI Subsystem Settings

PCI Bus Driver Versio V2.05.02

PCI Common Settings:

PCI Latency Timer:

[32 PCI Bus Clocks]

[64 PCI Bus Clocks]

[96 PCI Bus Clocks]
[128 PCI Bus Clocks]
[160 PCI Bus Clocks]
[192 PCI Bus Clocks]
[224 PCI Bus Clocks]
[248 PCI Bus Clocks]

VGA Palette Snoop:

[Disabled]
[Enabled]

PERR# Generation:

[Disabled]
[Enabled]

SERR# Generation:

[Disabled]
[Enabled]

3.4.2 ACPI Settings

Enable ACPI Auto Conf:

[Disabled]
[Enabled]

Enable Hibernation:

[Enabled]
[Disabled]

ACPI Sleep State:

[Both S1 and S3 available for OS to choose from]
[Suspend Disabled]
[S1 only (CPU Stop Clock)]
[S3 only (Suspend to RAM)]

Lock Legacy Resources:

[Disabled]
[Enabled]

S3 Video Repost:

[Disabled]
[Enabled]

3.4.3 CPU Configuration

Processor Type	Intel(R) Atom(TM) CPU N2600
EMT64	Not Supported
Processor Speed	1600MHz
System Bus Speed	400MHz
Ratio Status	16
Actual Ratio	16
System Bus Speed	400MHz
Processor Stepping	30661
Microcode Revision	269
L1 Cache RAM	2x56 k
L2 Cache RAM	2x512 k
Processor Core	Dual
Hyper-Threading	Supported

Hyper-Threading:

[Enabled]
[Disabled]

Execute Disable Bit:

[Enabled]
[Disabled]

Limit CPUID Maximum:

[Disabled]
[Enabled]

3.4.4 Thermal Configuration

CPU Thermal Configuration

DTS SMM

[Disabled]
[Enabled]

Platform Thermal Configuration

Critical Trip Point [POR]

Active Trip Point Lo [55 C]

Active Trip Point Hi [71C]

Passive Trip Point [95]

Passive TC1 Value 1

Passive TC2 Value 5

Passive TSP Value 10

3.4.5 IDE Configuration

SATA Port0 Not Present
SATA Port1 Not Present

SATA Controller(S):

[Enabled]
[Disabled]

Configure SATA as:

[IDE]
[AHCI]

Misc Configuration for hard disk

3.4.6 USB Configuration

USB Configuration
USB Devices:
1 Drive , 1 keyboard
Legacy USB Support:

[Enabled]
[Disabled]

EHCI Hand-off:

[Disabled]
[Enabled]

USB hardware delays a
USB transfer time-out:

[20 sec]
[10 sec]
[5 sec]
[1 sec]

Device reset time-out:

[20 sec]
[10 sec]
[30 sec]
[40 sec]

Device power-up delay

[Auto]
[Manual]

3.4.7 W83627UHG Super IO Configuration

W83627UHG Super IO ch W83627UHG

Serial Port 1 Configuration

UART Mode Selection:

[RS-232]

[RS-485]

[RS-422]

Serial Port 2 Configuration

Serial Port 3 Configuration

UART Mode Selection:

[RS-485]

[RS-422]

Serial Port 4 Configuration

Serial Port 5 Configuration

Serial Port 6 Configuration

3.4.8 W83627UHG HW Monitor

PC Health Status

System Temperature1 : +38

System Speed : N/A

VCORE : +0.968V

+12V : +12.302V

+3.3V : +3.320V

+1.5V : +1.528V

AVCC : +5.203V

VCC5V : +5.216V

VSBS : +5.203V

VBAT : +3.334V

3.4.9 Serial Port Console Redirection

COM0

Console Redirection

[Enabled]

[Disabled]

Console Redirection Settings

Serial Port for Out-of-Band Management/

Windows Emergency Management Services (EMS)

Console Redirection

[Disabled]

[Enabled]

Console Redirection Settings

3.4.10 PPM Configuration

PPM Configuration

EIST:

[Enabled]

[Disabled]

CPU C State Report

[Enabled]

[Disabled]

Enhanced C State

[Enabled]

[Disabled]

CPU Hard C4E

[Enabled]

[Disabled]

CPU C6 State

[Enabled]

[Disabled]

C4 Exit Timing

[Fast]

[Default]

[Slow]

C-state POPDOWN

[Enabled]

[Disabled]

C-state POPUP

[Enabled]

[Disabled]

3.5 Chipset Settings

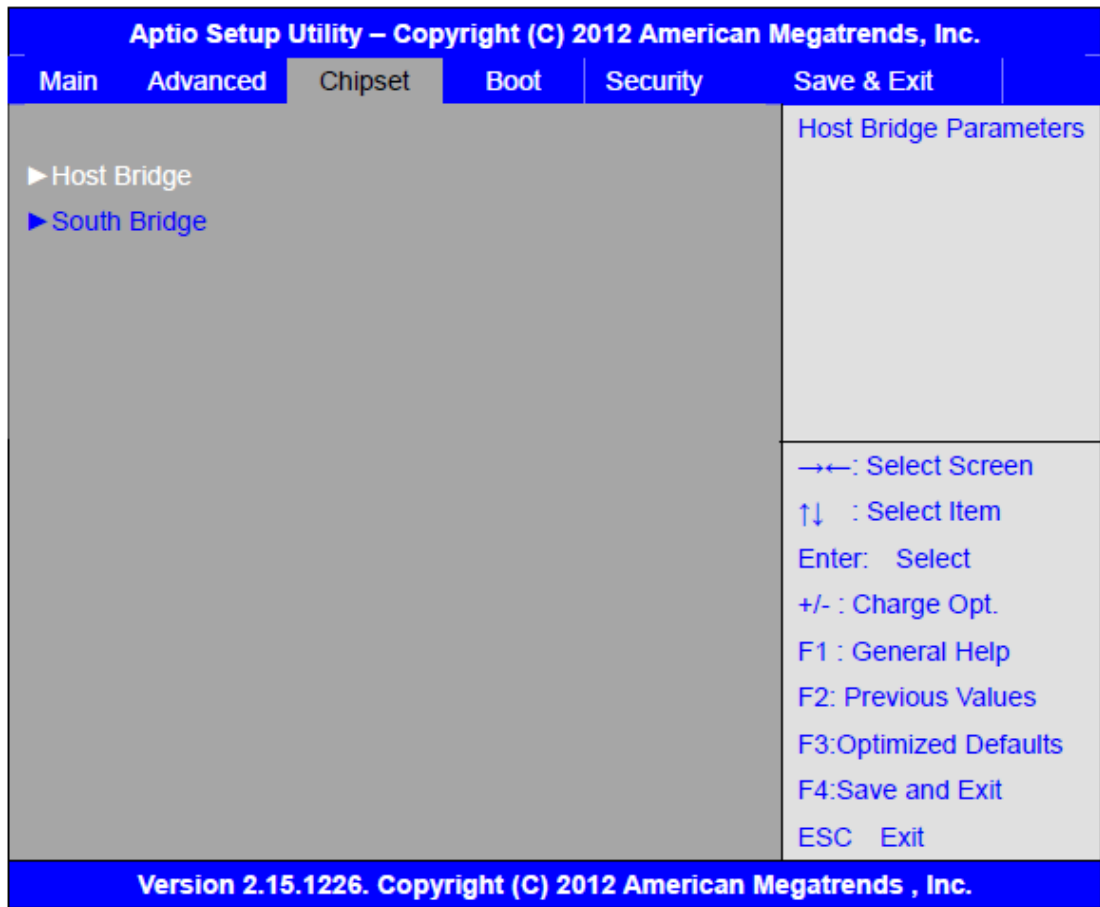

3.5.1 Host Bridge

▶ Memory Frequency and Timing

▶ Intel IGD Configuration

***** Memory Information *****

Memory Frequency	800 MHz(DDR3)
Total Memory	2048 MB
DIMM#0	Not Present
DIMM#1	2048 MB

Memory Frequency and Timing

MRC Fast Boot

[Enabled]

	[Disabled]
Max TOLUD	[Dynamic] [1GB] [1.25GB] [1.5GB] [1.75GB] [2GB] [2.25GB] [2.5GB] [2.75GB] [3GB] [3.25GB]
Intel IGD Configuration	
IGFX – Boot Type	[VBIOS Default] [VGA] [LVDS] [HDMI] [VGA + LVDS] [VGA + HDMI] [LVDS + HDMI]
LCD Panel Type	[VBIOS Default] [640x480, 18bit] [800x480, 18bit] [800x600, 18bit] [1024x600, 18bit] [1024x768, 18bit] [1280x768, 18bit] [1280x800, 18bit] [1280x1024, 18bit] [1366x768, 18bit] [1024x768, 24bit] [1280x768, 24bit] [1280x800, 24bit] [1280x1024, 24bit] [1366x768, 24bit]
Panel Scaling	[Auto] [Force Scaling] [off]

Active LFP	[Maintain Aspect Ratio]
	[LVDS]
IGD Clock Source	[No LVDS] [EDP]
	[External Clock]
Fixed Graphics Memory	[Internal Clock]
ALS Support	[128MB] [256MB]
Back light Control	[Disabled] [Enabled]
Back light Logic	[DC] [PWM]
Back light Control Lev	[Positive] [Negative]
	[Auto]
	[Disabled]
	[Level 8]
	[Level 1]
	[Level 2]
	[Level 3]
	[Level 4]
	[Level 5]
	[Level 6]
	[Level 7]
	[Level 8]
	[Level 9]
	[Level 10]
	[Level 11]
	[Level 12]
	[Level 13]
	[Level 14]
	[Level 15]

3.5.1 South Bridge

TPT Devices	[Enable]
PCI Express Root Port 0	[Disabled]
PCI Express Root Port 1	
PCI Express Root Port 2	
PCI Express Root Port 3	
DMI Link ASPM Control	
PCI-Exp. High Priorit	[Disabled]
	[Enabled]
High Precision Event Timer Configuration	
High Precision Timer	[Enabled]
	[Disabled]
SLP_S4 Assertion Widt	[1-2 Seconds]
	[2-3 Seconds]
	[3-4 Seconds]
	[4-5 Seconds]

3.6 Boot Settings

Aptio Setup Utility – Copyright (C) 2012 American Megatrends, Inc.					
Main	Advanced	Chipset	Boot	Security	Save & Exit
Boot Configuration					Number of seconds to Wait for setup
	Setup Prompt Timeout	1			Activation key.
	Bootup Numlock State	[On]			65535(0xFFFF)means Indef inite waiting.
	Quiet Boot	[Disabled]			
	Fast Boot	[Enabled]			
	Skip USB	[Disabled]			
	Skip PS2	[Disabled]			
	CSM16 Module Version	07.69			
	Gatea20 Active	[Upon Request]			
	Option ROM Messages	[Force BIOS]			
	Interrupt 19 Capture	[Immediate]			
	Driver Option Priorities				→←: Select Screen
	Boot Option Priorities				↑↓ : Select Item
	Boot Option Priorities				Enter: Select
	Boot Option #1	[SATA PM: Hitachi...]			+/- : Change Opt.
	Boot Option #2	[...]			F1 : General Help
	Hard Drive BBS Priorities				F2: Previous Values
	► CSM Parameters				F3:Optimized Defaults
					F4:Save and Exit
					ESC Exit
Version 2.15.1226. Copyright (C) 2012 American Megatrends , Inc.					

Setup Prompt Timeout	[1]
Bootup Numlock State	[On] [off]
Quiet Boot	[Disabled] [Enabled]
Fast Boot	[Enabled] [Disabled]
Skip VGA	[Enabled] [Disabled]
Skip USB	[Disabled] [Enabled]
Skip PS2	[Disabled] [Enabled]
CSM16 Module Version	07.69
Gatea20 Active	[Upon Request] [Always]
Option ROM Messages	[Force BIOS] [Keep Current]
Interrupt 19 Capture	[Immediate] [Postponed]
Boot Option #1	
Boot Option #2	
.....	
Hard Drive BBS Priorities	Sets the system boot order [SATA PM:***...] Boot Option #1 SATA PM:***... ***** Disabled
CSM Parameters	
Launch CSM	[Always] [Never]
Boot option filter	[UEFI and Legacy] [Legacy only] [UEFI only]
Launch PXE OpROM poli	[Do not Launch] [UEFI only] [Legacy only]
Launch Storage OpROM	[Legacy only] [Do not Launch] [UEFI only]

Launch Video OpROM po	[Do not Launch] [UEFI only] [Legacy only]
Other PCI device ROM	[UEFI OpROM] [Legacy OpROM]

3.7 Security Settings

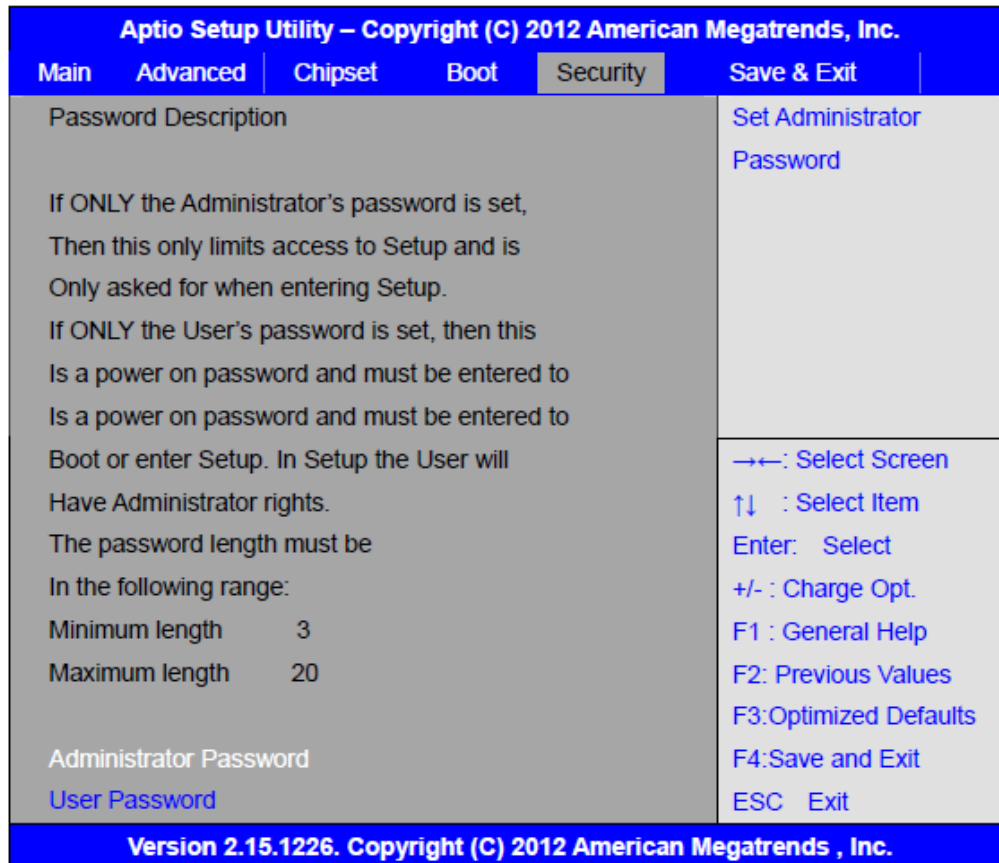

3.7.1 Administrator Password



3.7.2 User Password



Type the password with up to 20 characters and then press <Enter> key. This will clear all previously typed CMOS passwords. You will be requested to confirm the password. Type the password again and press <Enter> key. You may press <Esc> key to abandon password entry operation.

To clear the password, just press <Enter> key when password input window pops up. A confirmation message will be shown on the screen as to whether the password will be disabled. You will have direct access to BIOS setup without typing any password after system reboot once the password is disabled.

Once the password feature is used, you will be requested to type the password each time you enter BIOS setup. This will prevent unauthorized persons from changing your system configurations.

Also, the feature is capable of requesting users to enter the password prior to system boot to control unauthorized access to your computer. Users may enable the feature in Security Option of Advanced BIOS Features. If Security Option is set to System, you will be requested to enter the password before system boot and when entering BIOS setup; if Security Option is set to Setup, you will be requested for password for entering BIOS setup.

3.8 Save & Exit Settings



Save Changes and Exit	
Save & Exit Setup save Configuration and exit?	[Yes]
	[No]
Discard Changes and Ext	
Exit Without Saving Quit without saving?	[Yes]
	[No]
Save Changes and Reset	
Save & reset Save Configuration and reset?	[Yes]
	[No]
Discard Changes and Reset	
Reset Without Saving Reset without saving?	[Yes]
	[No]
Save Changes	
Save Setup Values Save configuration?	[Yes]
	[No]
Discard Changes	
Load Previous Values Load Previous Values?	[Yes]
	[No]
Restore Defaults	
Load Optimized Defaults Load optimized Defaults?	[Yes]
	[No]
Save user Defaults	
Save Values as User Defaults Save configuration?	[Yes]
	[No]
Restore user Defaults	
Restore User Defaults Restore User Defaults?	[Yes]
	[No]
Launch EFI Shell from filesystem device	
WARNING Not Found	[ok]

Chapter 4 Installation of Drivers

This chapter describes the installation procedures for software and drivers under the windows 7 32-bit. The software and drivers are included with the motherboard. The contents include **Intel chipset driver, VGA driver, LAN drivers, Audio driver** Installation instructions are given below.

Important Note:

After installing your Windows operating system, you must install first the Intel Chipset Software Installation Utility before proceeding with the installation of



4.1 Intel Chipset Driver

To install the Intel chipset driver, please follow the steps below.

Step 1. Select **Intel (R) Chipset NM10 Express** from the list



Step 2. Click **Next** to setup program.



Step 3. Read the license agreement. Click **Yes** to accept all of the terms of the license agreement.



Step 4. Click **Next** to continue.

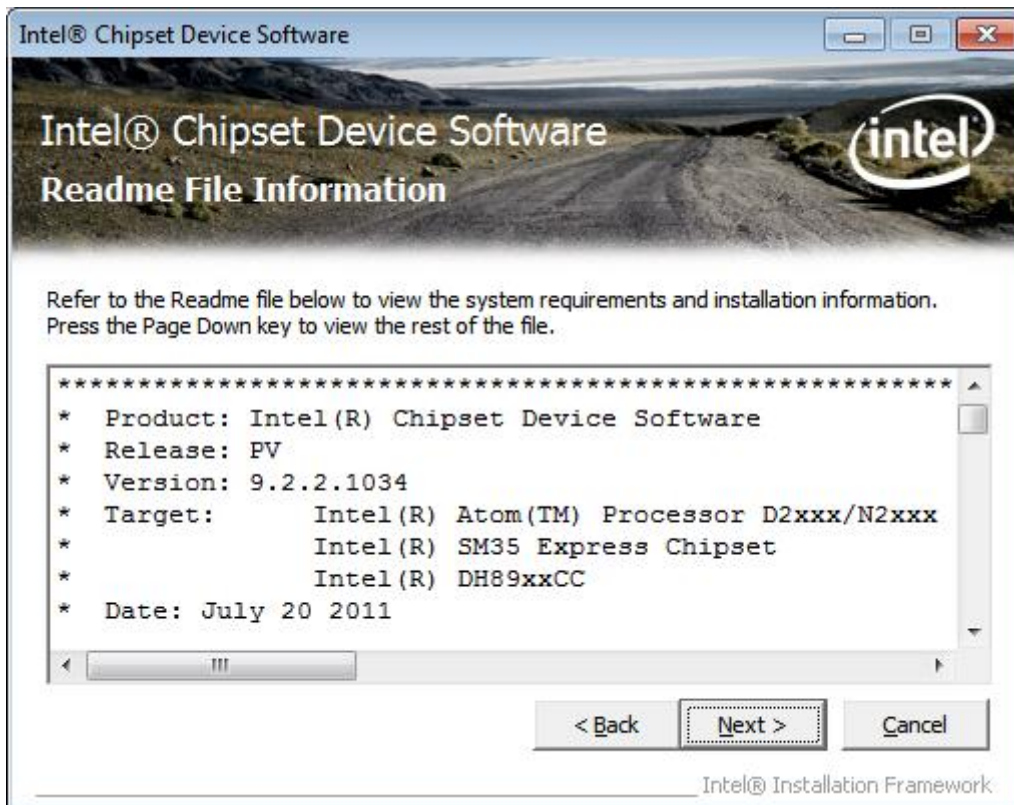

Step 5. Click Next.

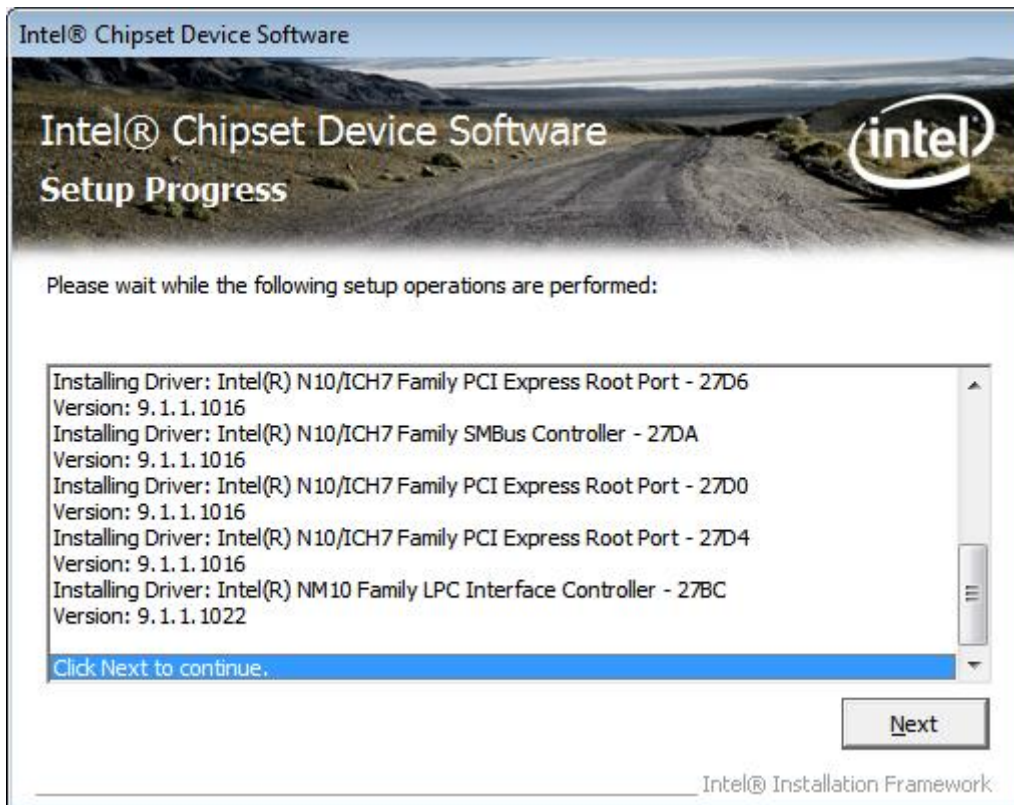

Step 6. Select Yes, I want to restart this computer now. Click **Finish**, then remove any installation media from the drives.



4.2 Intel Graphics Media Accelerator Driver

To install the VGA drivers, follow the steps below to proceed with the installation.

Step 1.Select Intel(R) VGA Chipset Driver.



Step 2. Tick **Automatically run WinSAT and enable the Windows Aero desktop theme(if supported).** Click **Next**.

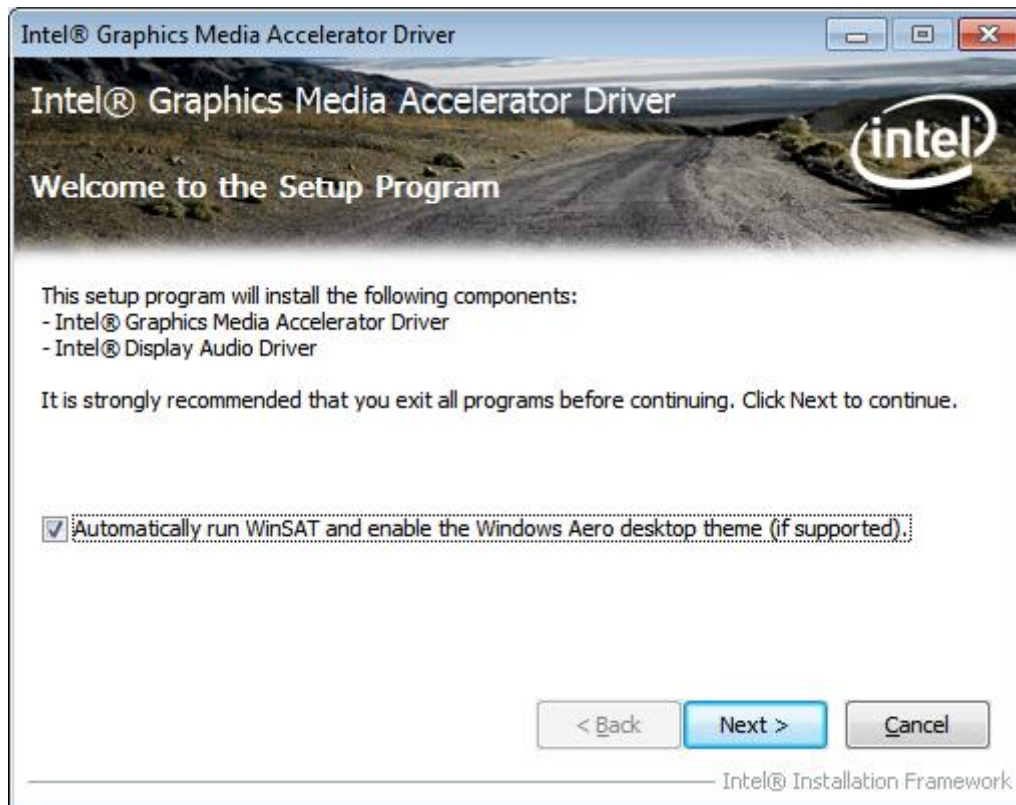

Step 3. Read license agreement. Click **Yes**.



Step 4. Click **Next**.

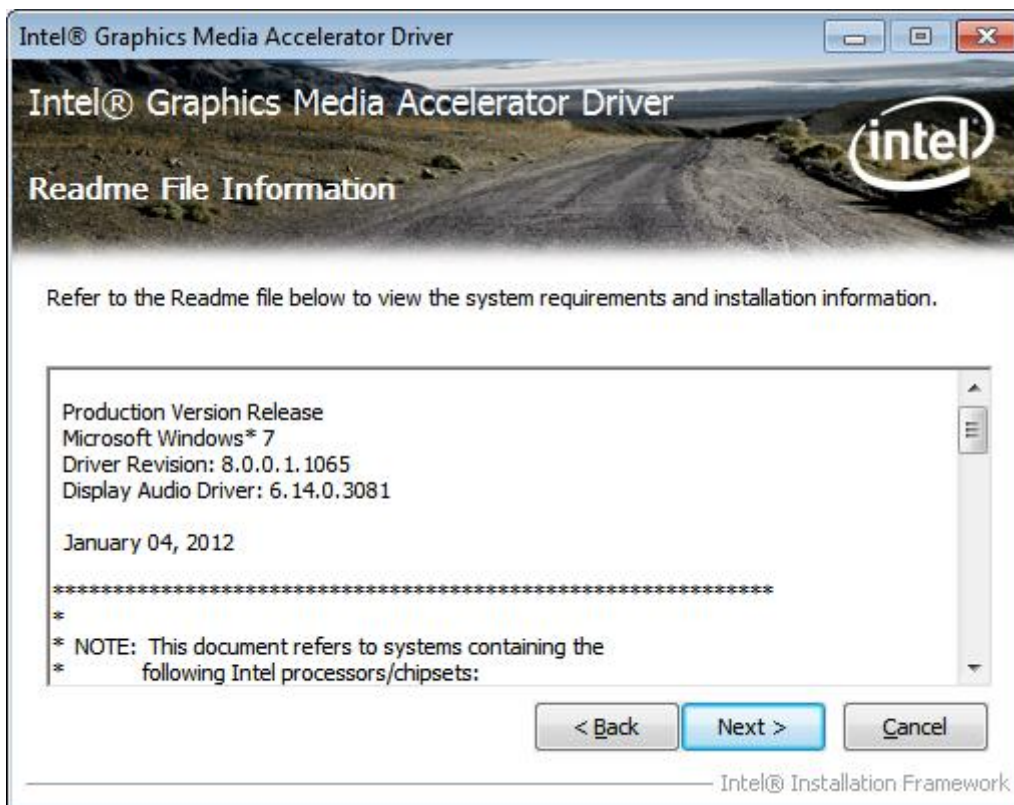

Step 5. Click Next.

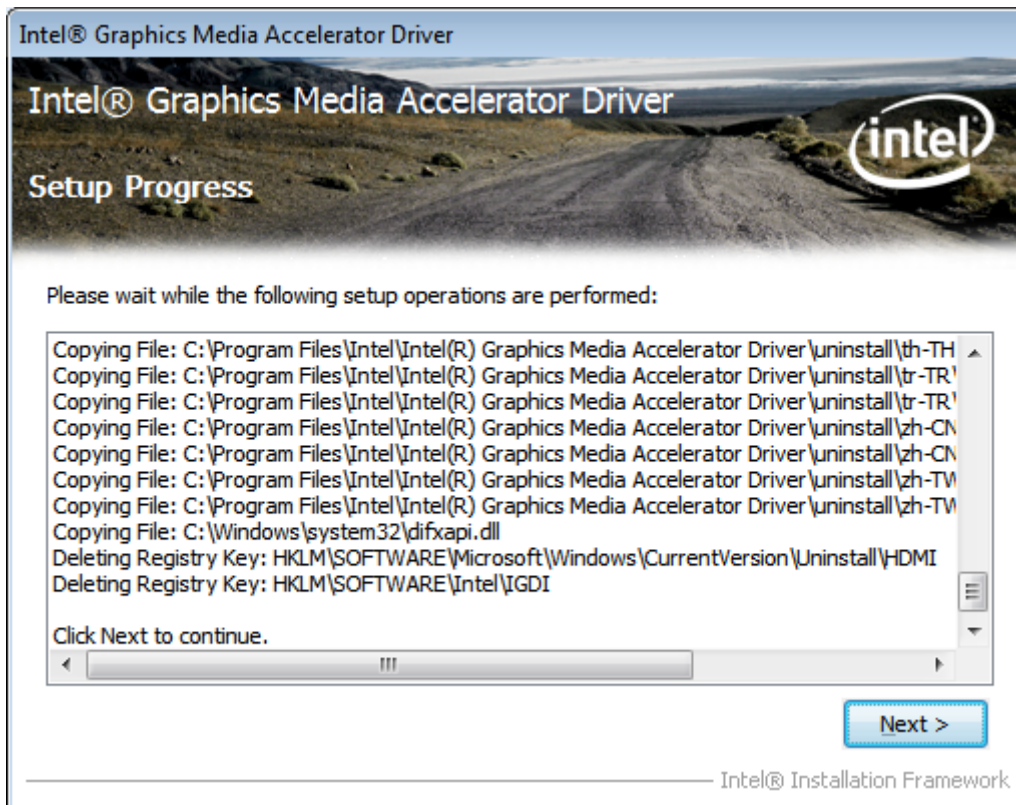

Step 6. To restart the computer, select Yes, I want to restart this computer now. Then click Finish.

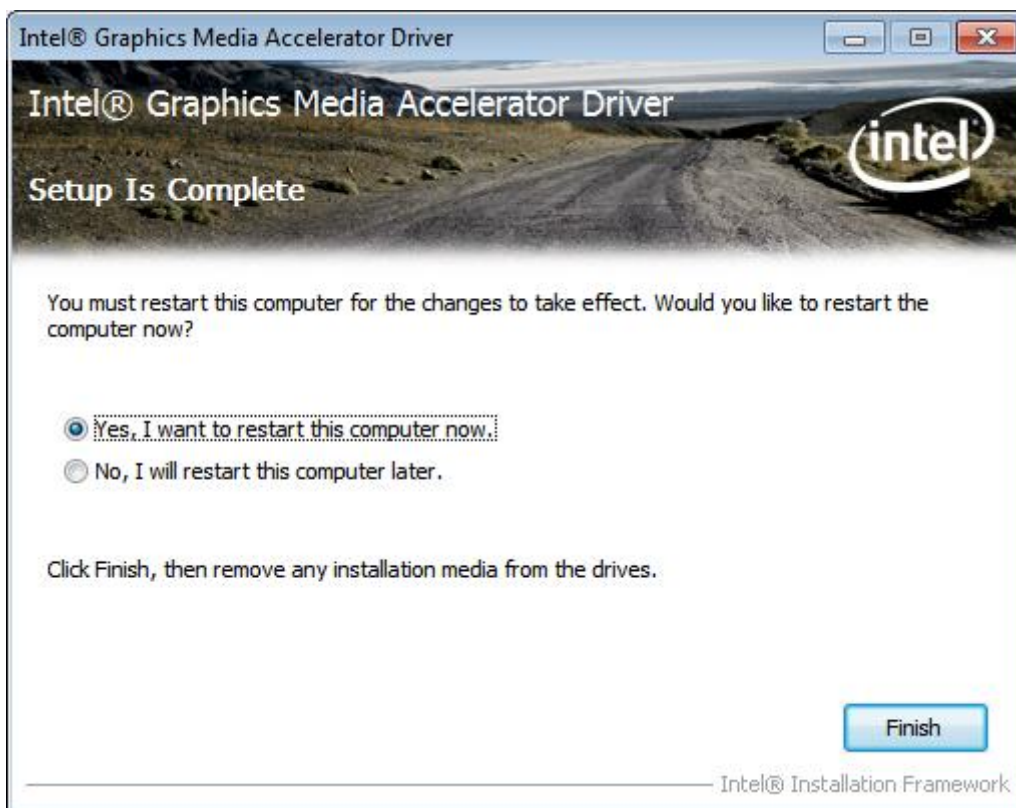

4.3 Intel (R) Network Adapter

To install the Intel (R) Network Adapter device driver, please follow the steps below.

Step 1. Select LAN Driver.



Step 2. Select ARCHMI-7"~15".



Step 3. Click **Next** to continue.

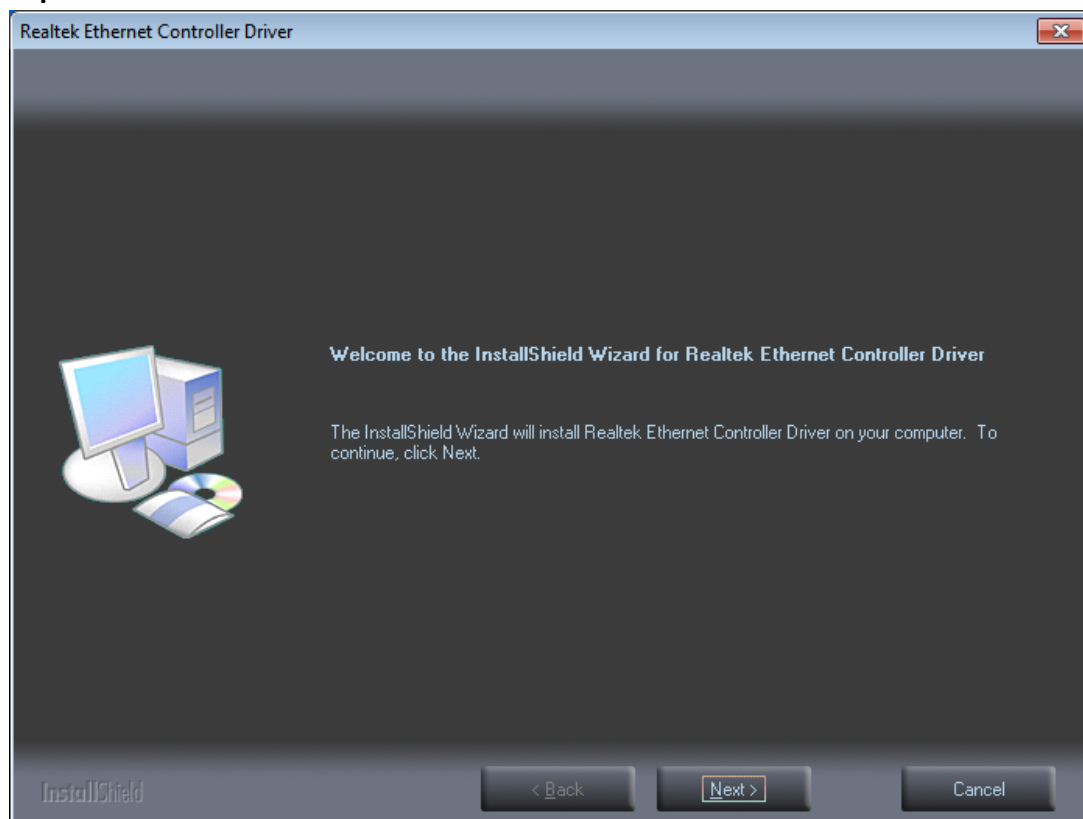

Step 4. Click **Install** to begin the installation.

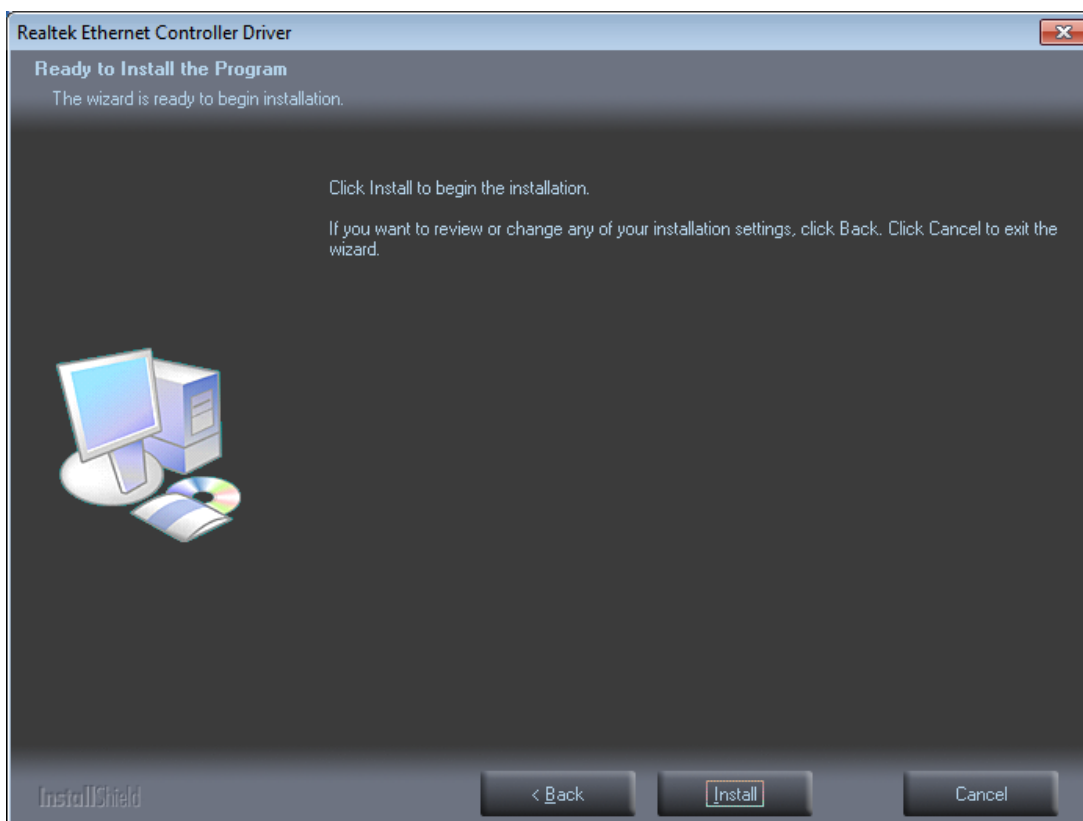

Step 5. Click **Finish** to exist the wizard.

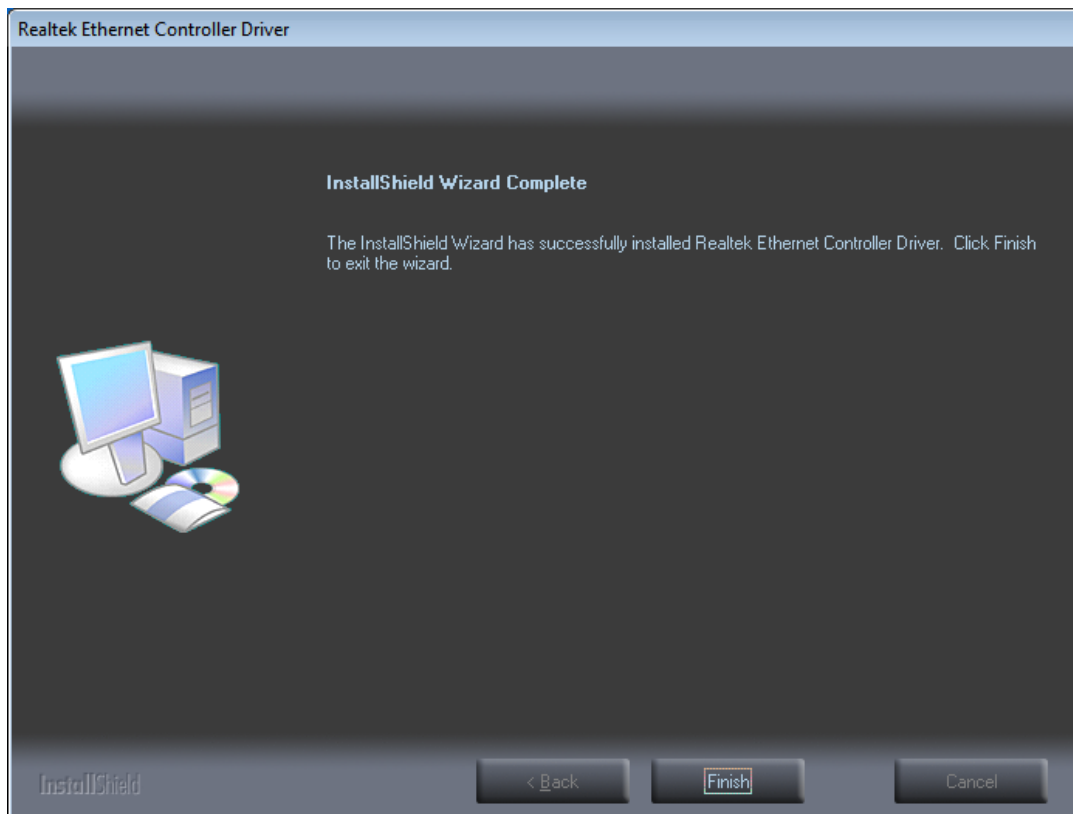

4.4 Realtek ALC662 HD Audio Codec Driver Installation

To install the Realtek ALC662 HD Audio Codec Driver, please follow the steps below.

Step 1. Select **Realtek AL662 Audio Codec Driver** from the list



Step 2. Click **Next** to continue.

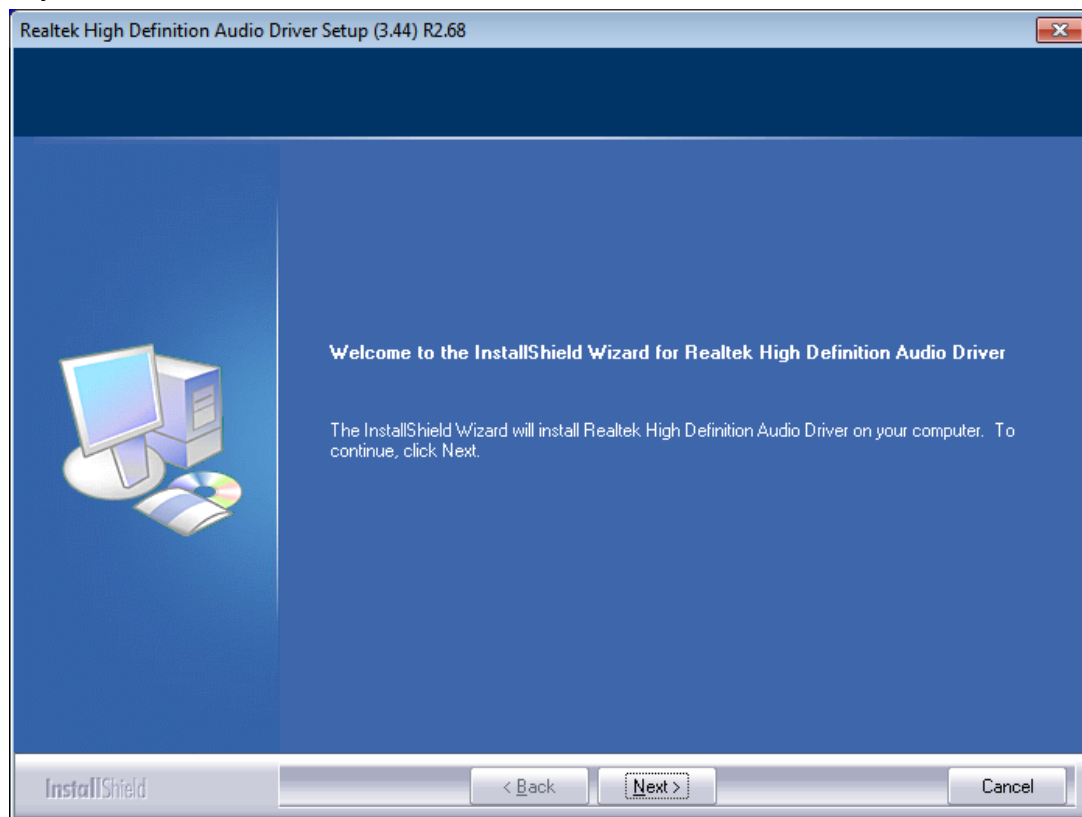

Step 3. Click **Yes, I want to restart my computer now.** Click **Finish** to complete the installation.

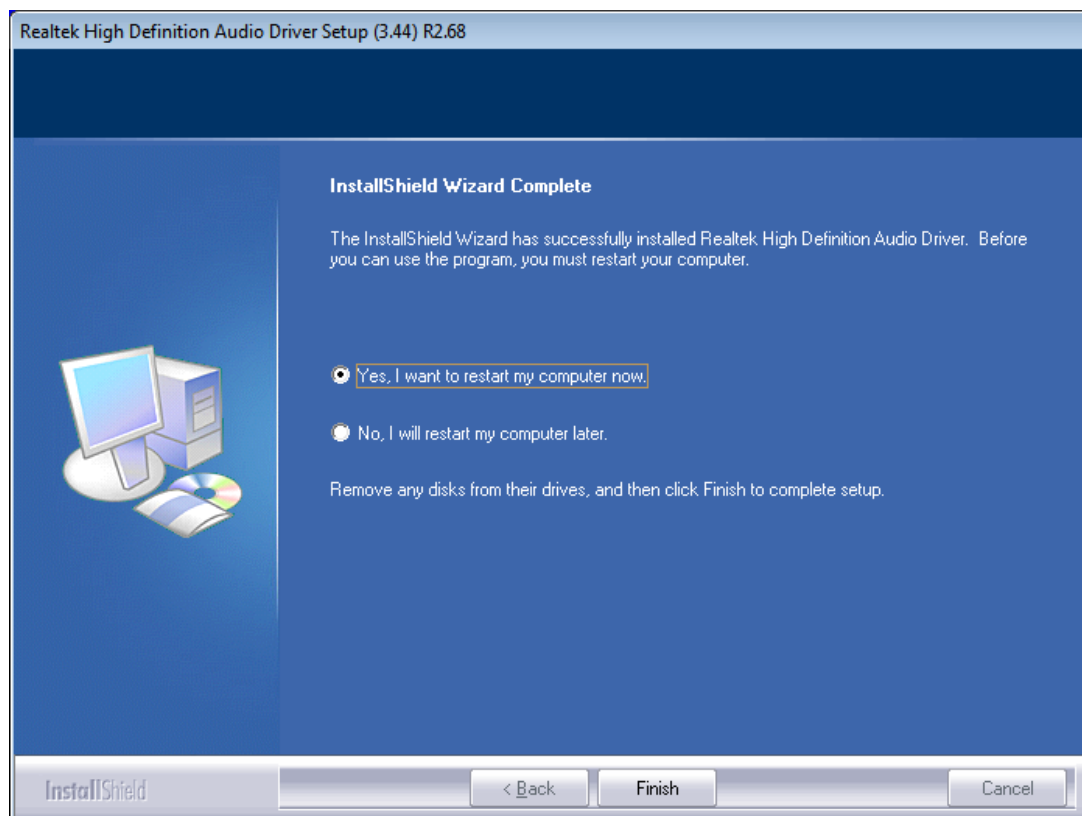

Chapter 5 Touch Screen Installation

This chapter describes how to install drivers and other software that will allow your touch screen work with different operating systems.

5.1 Windows 2003/XP/Vista/7 Universal Driver

Installation for PenMount 6000 Series

Before installing the Windows 2003/XP/Vista/7 driver software, you must have the Windows 2003/XP/Vista/7 system installed and running on your computer. You must also have one of the following PenMount 6000 series controller or control boards installed: PM6500, PM6300.

5.1.1 Installing Software (Resistive Touch)

If you have an older version of the PenMount Windows 2003/XP/Vista/7 driver installed in your system, please remove it first. Follow the steps below to install the PenMount DMC6000 Windows 2003/XP/Vista/7 driver.

Step 1. Insert the product CD, the screen below would appear. Click touch panel driver.



Step 2. Select Resistive Touch.



Step 3. Click Next to continue.

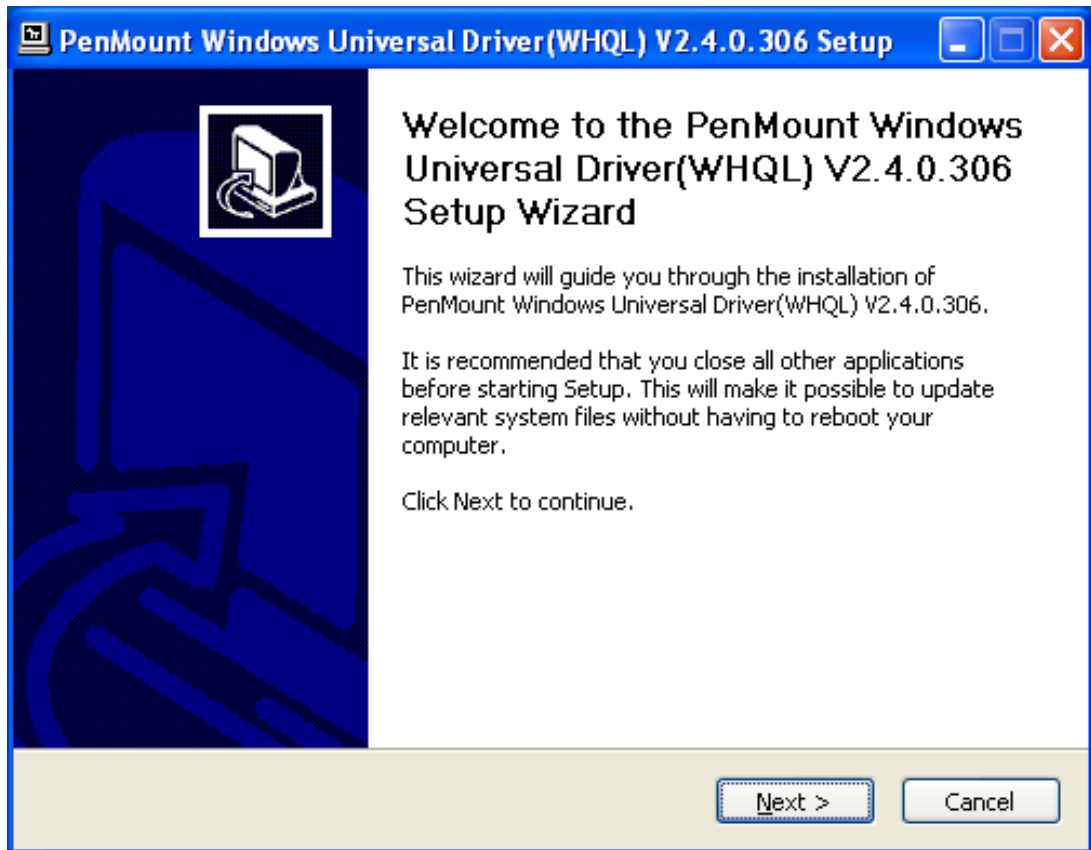

Step 4. Read the license agreement. Click **I Agree** to agree the license agreement.

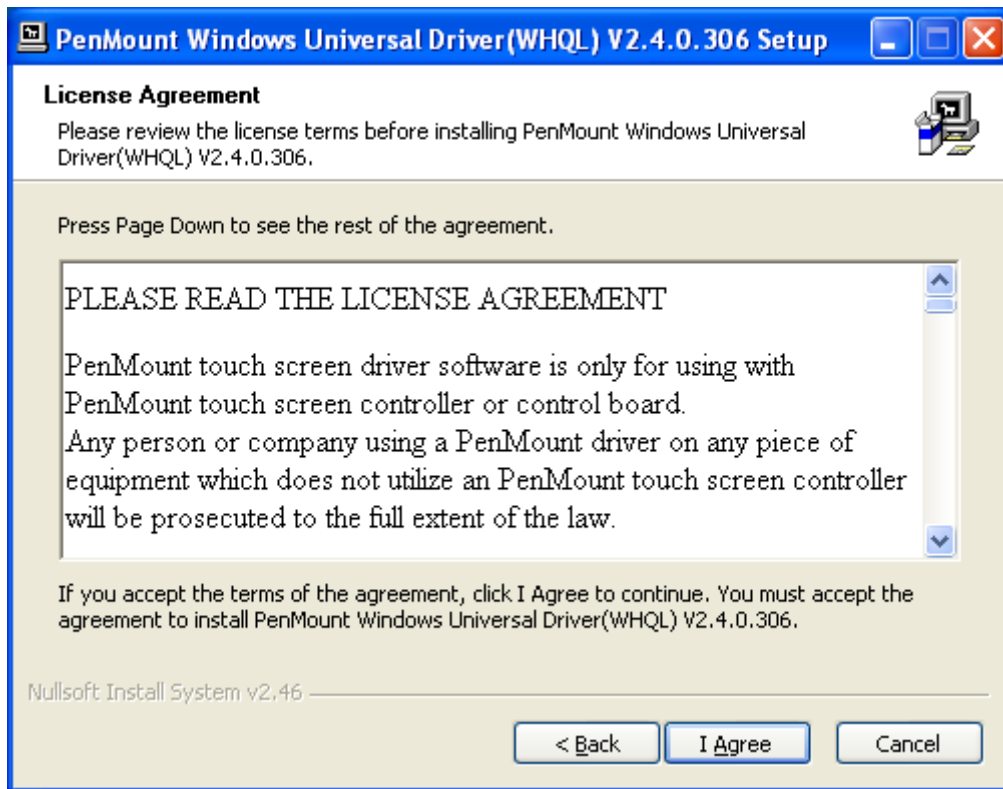

Step 5. Choose the folder in which to install PenMount Windows Universal Driver. Click **Install** to start the installation.

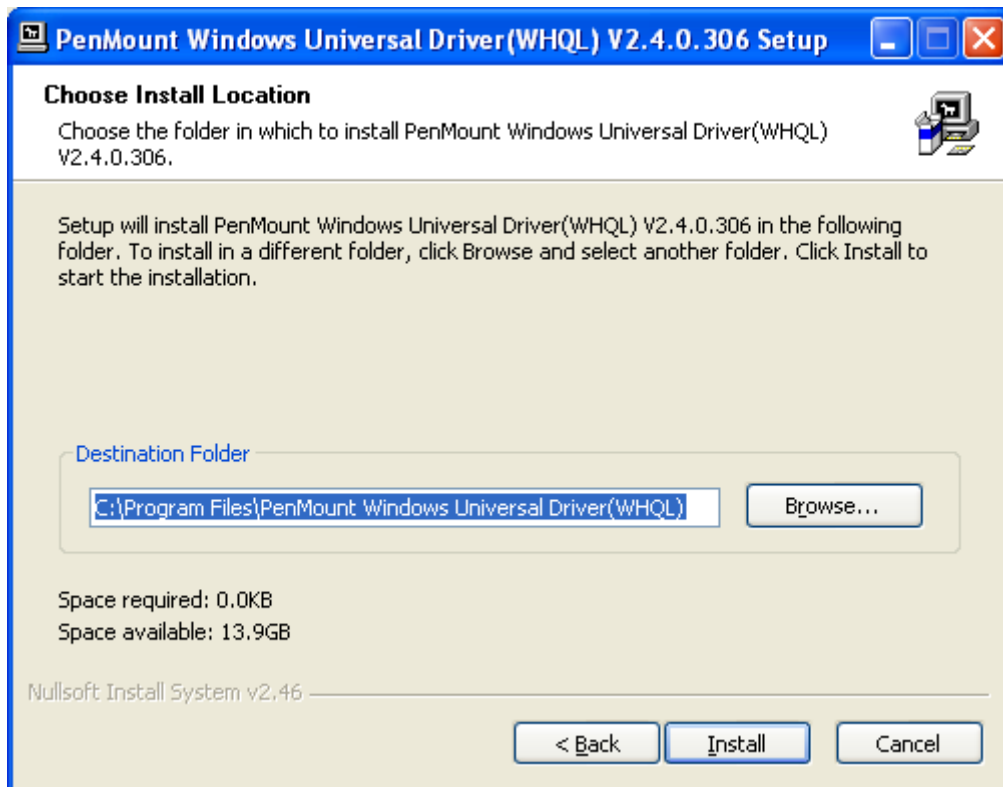

Step 6. Wait for installation. Then click **Next** to continue.

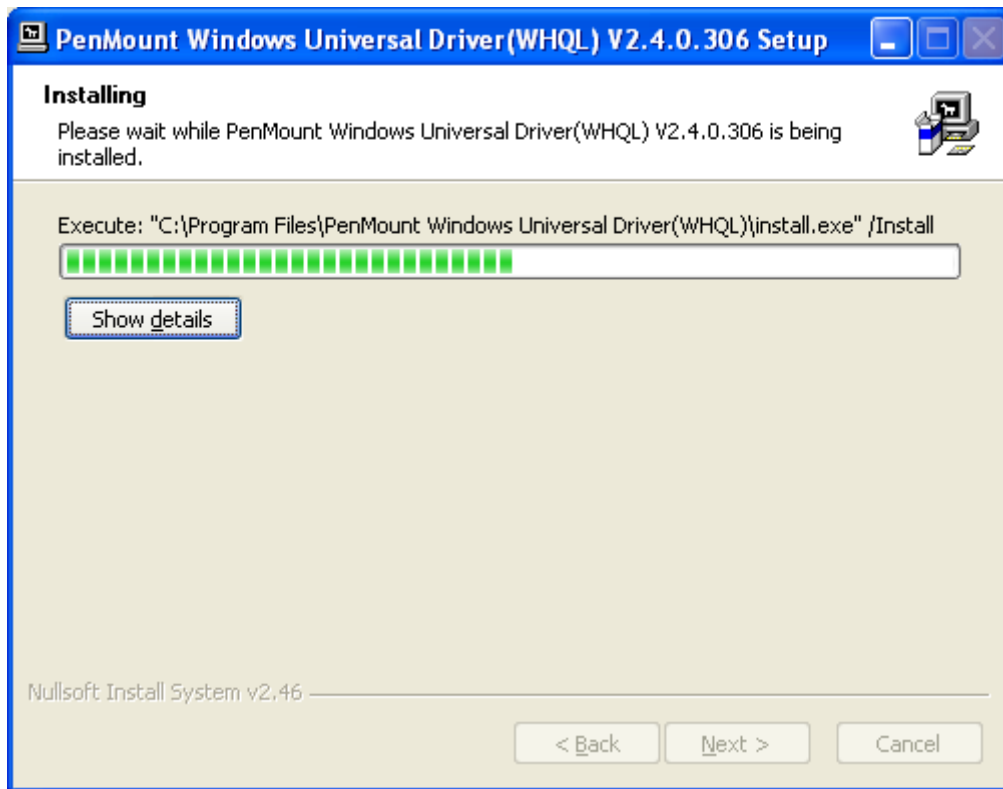

Step 7. Click **Continue Anyway**.



Step 8. Click **Finish** to complete installation.

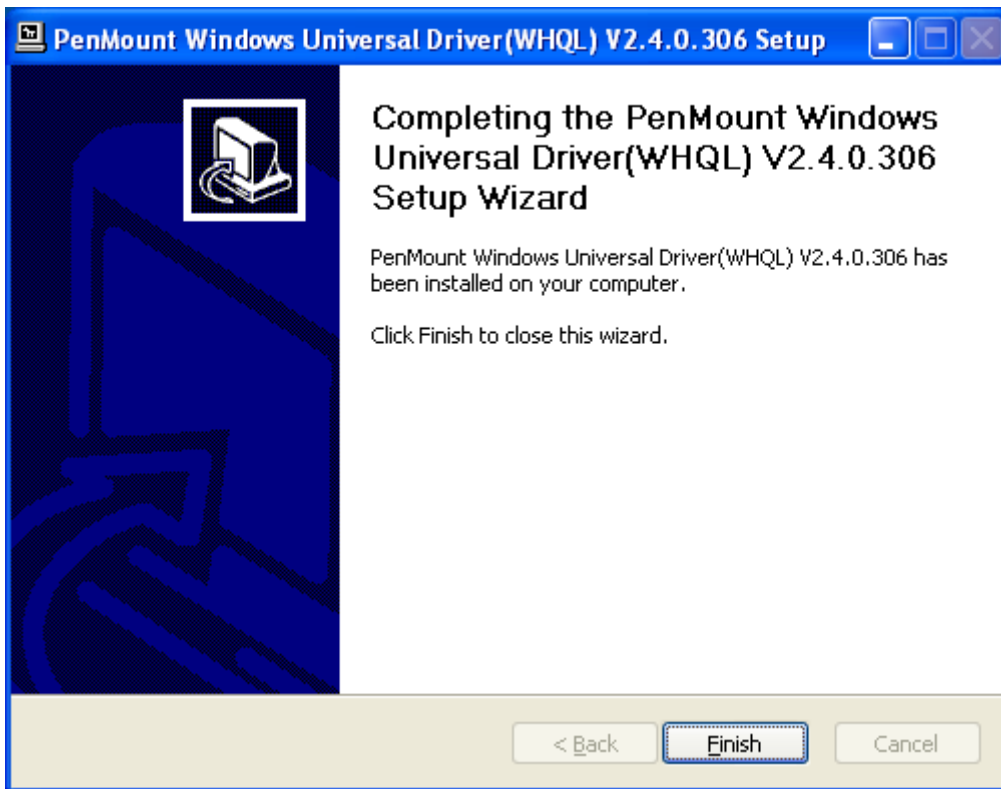

5.1.2 Installing Software (Projected Capacitive)

Step 1. Insert the product CD, the screen below would appear. Click **Touch Panel Driver**.



Step 2. Select Projected Capacitive.



Step 3. Click Next to continue.

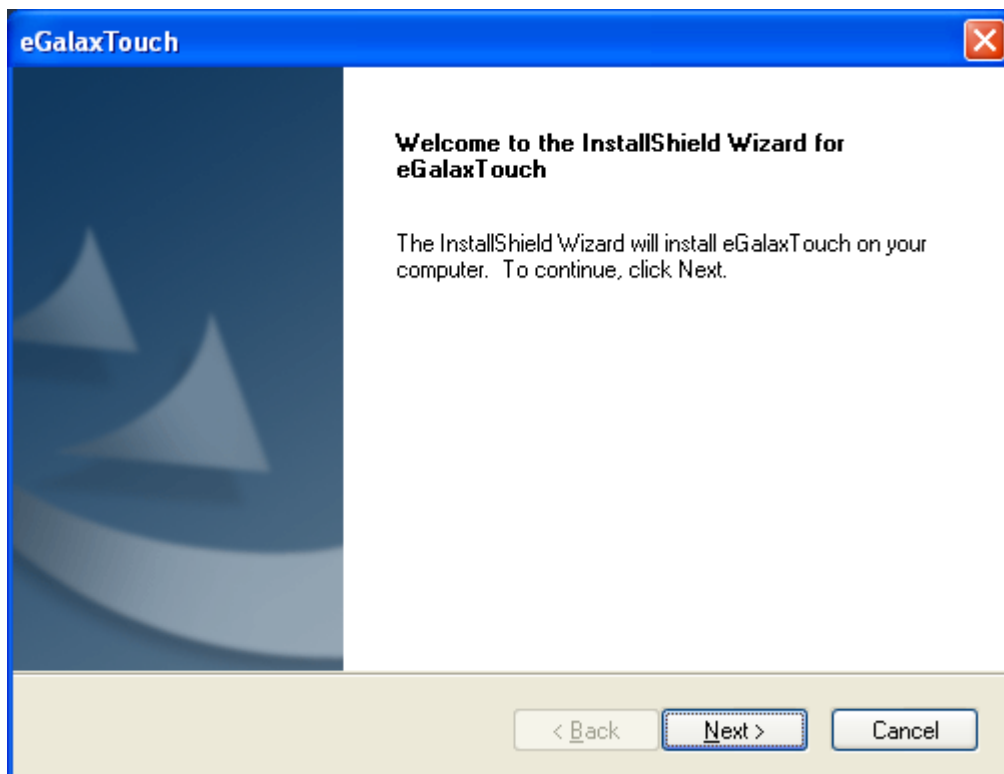

Step 4. Select **I accept the terms of the license agreement.** Click **Next.**

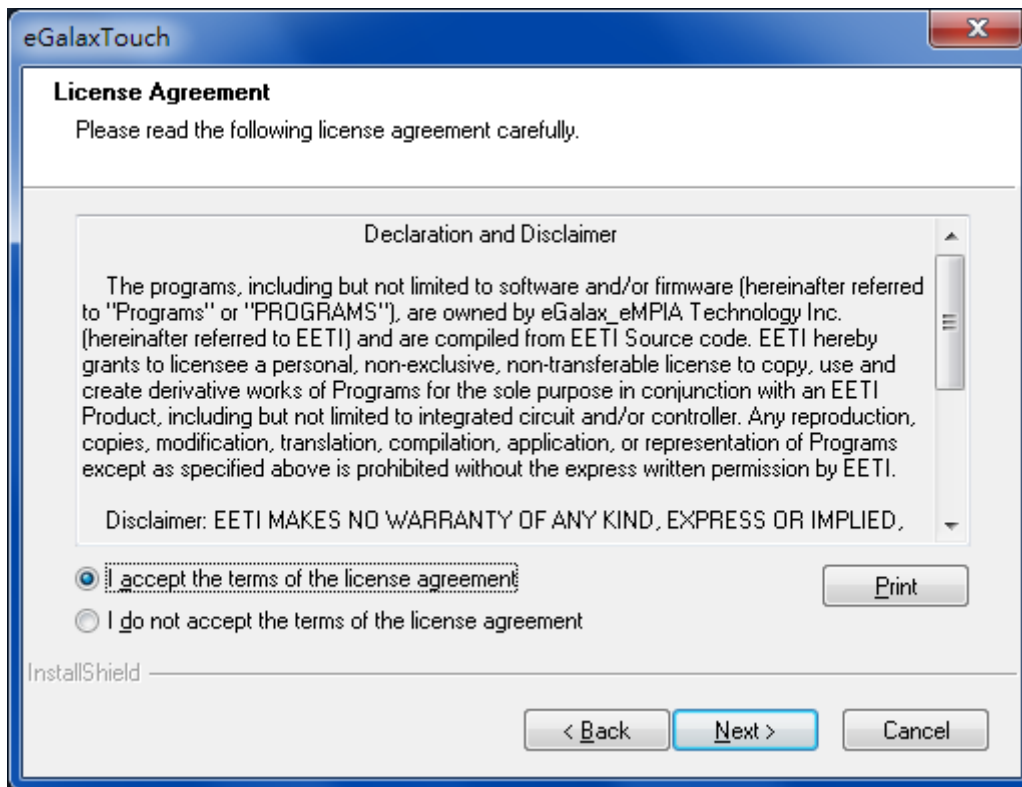

Step 5. Tick **Install RS232 interface driver.** Click **Next.**

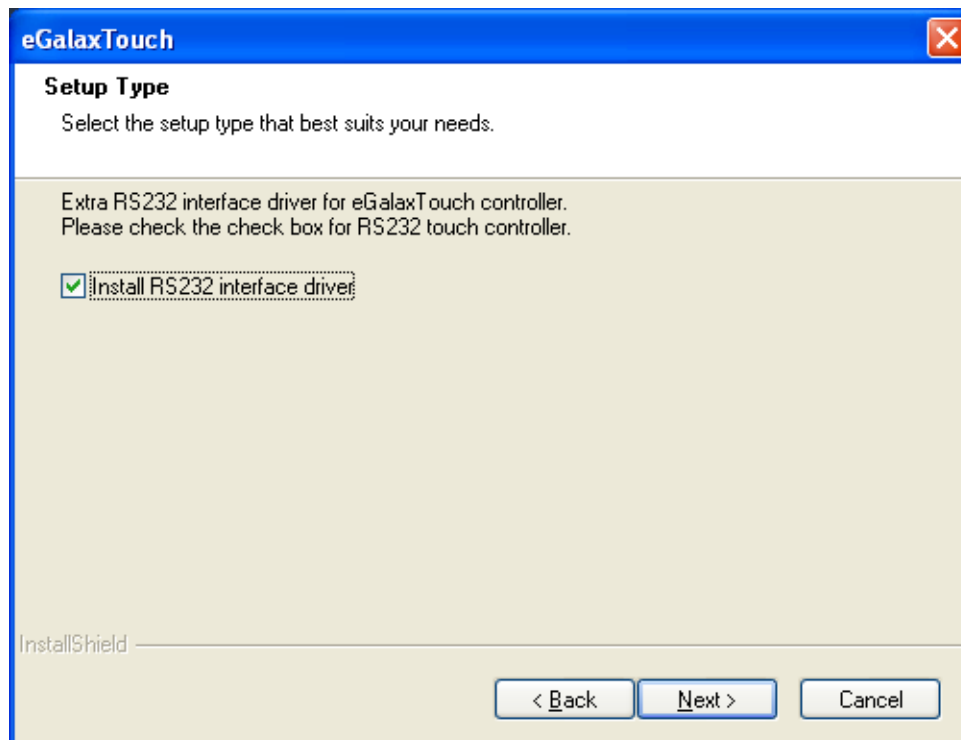

Step 6. Select None. Click Next.

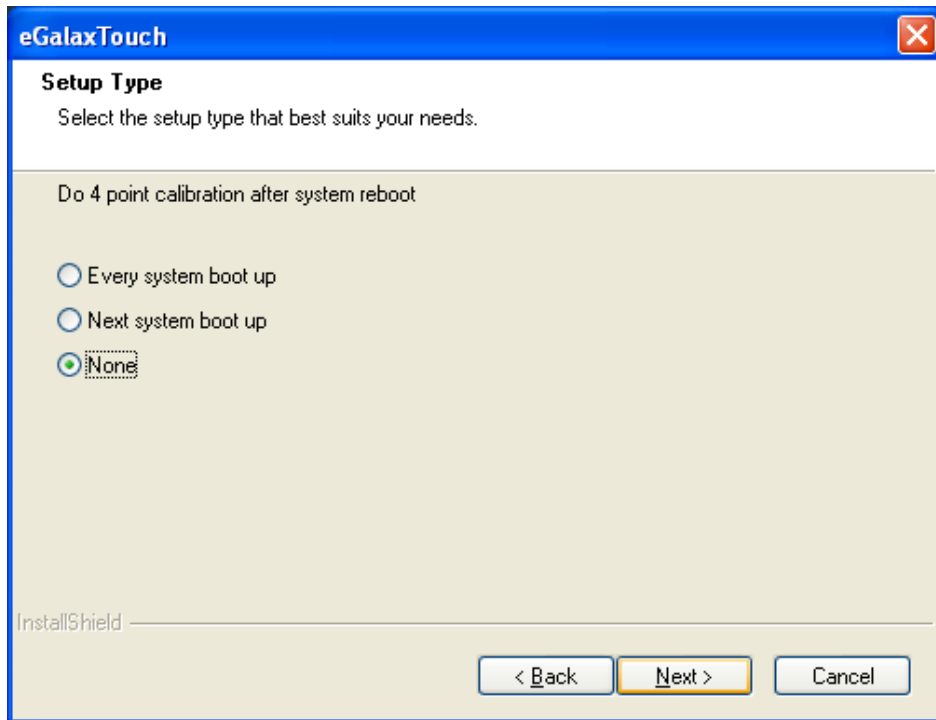

Step 7. Click OK.

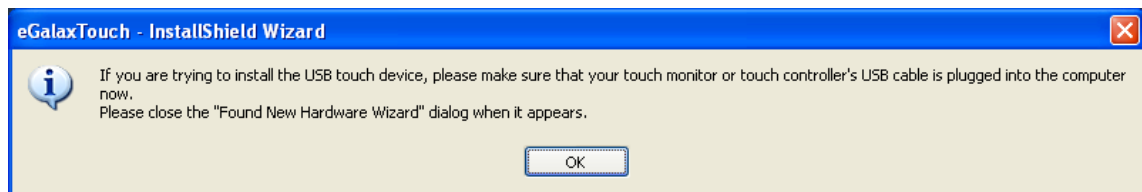

Step 8. Tick Support Multi-Monitor System. Click Next.

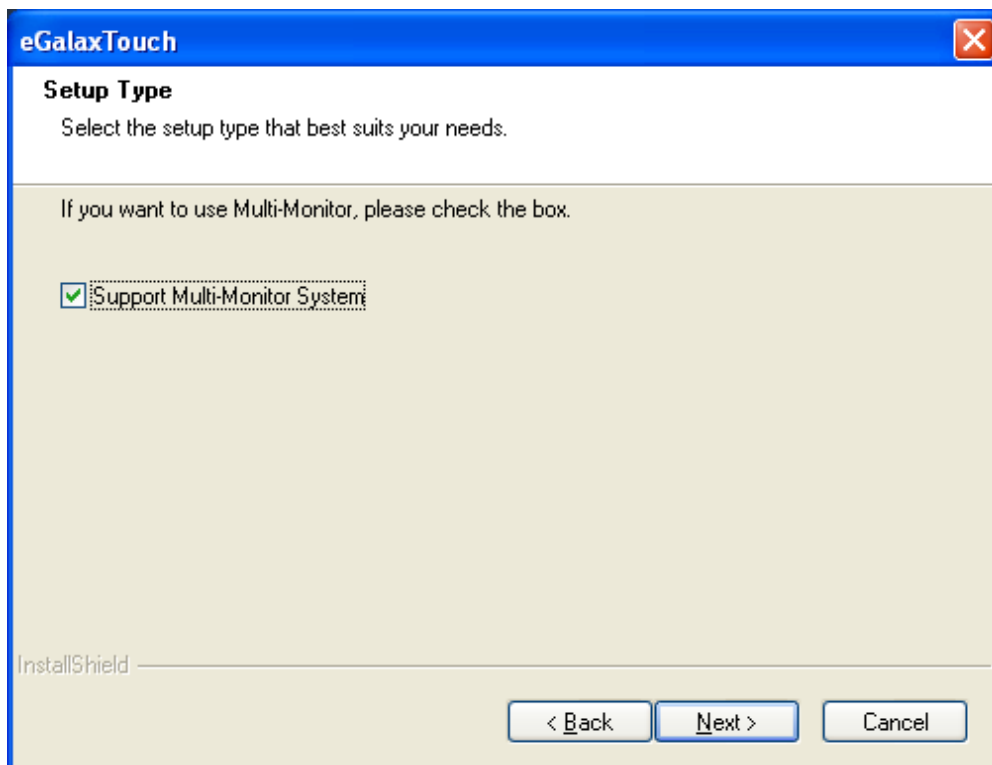

Step 9. Go to **C:\Program Files\eGalaxTouch**. Click **Next**.

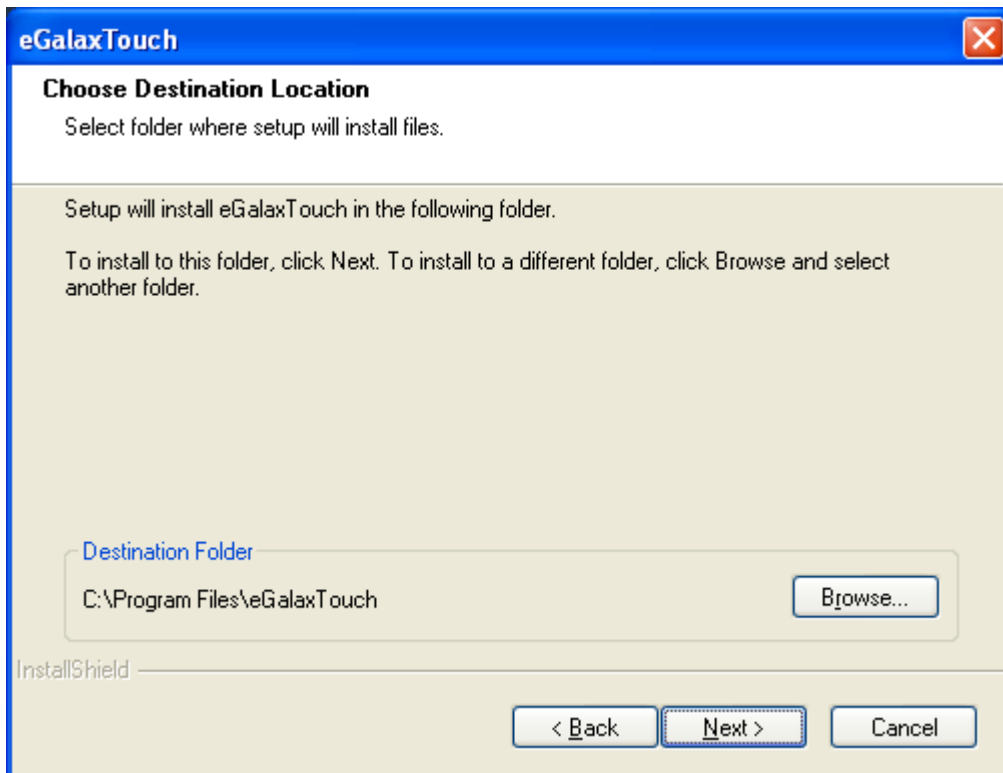

Step 10. Click **Next**.

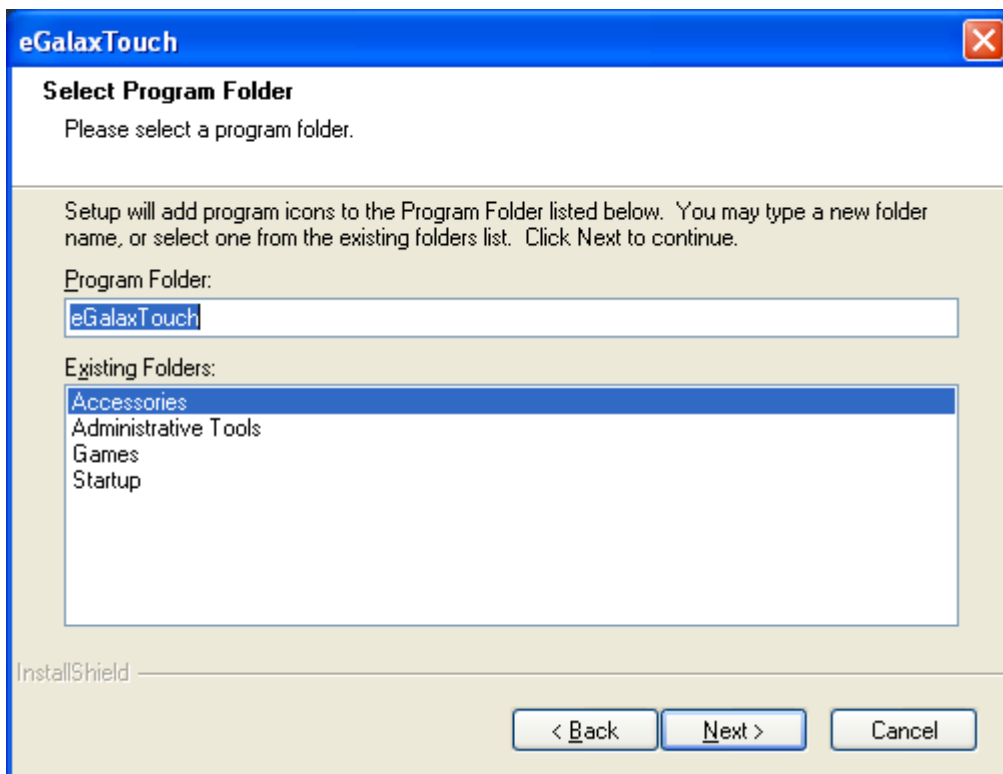

Step 11. Tick **Create a eGalaxTouch Utility shortcut on desktop.** Click **Next.**

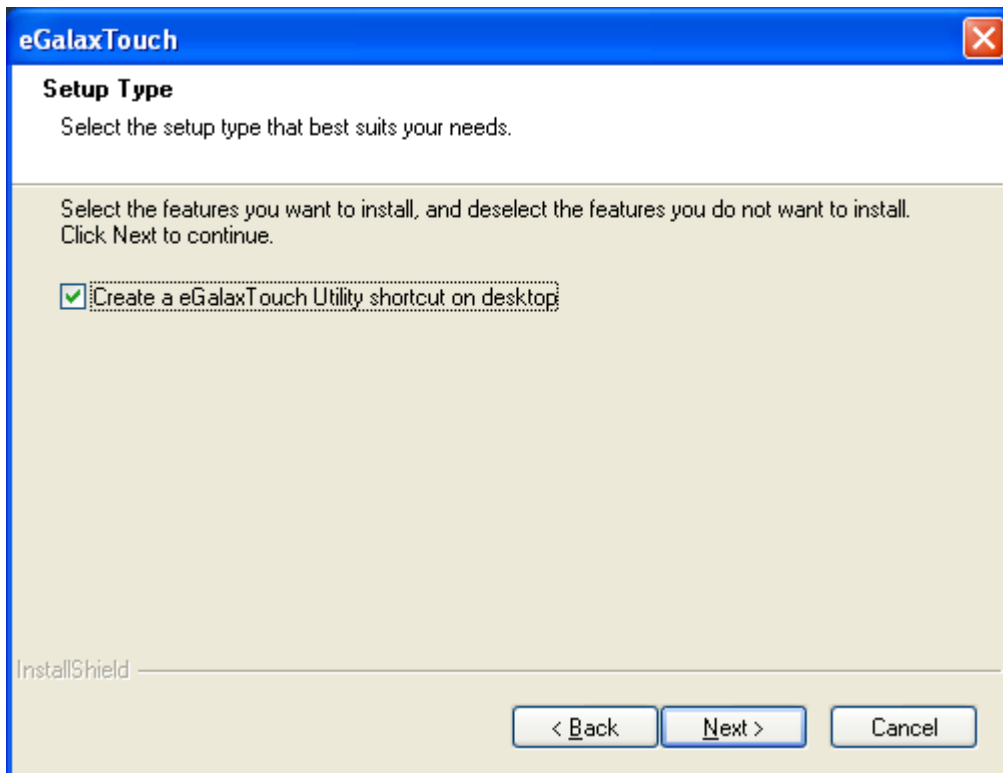

Step 12. Wait for installation.

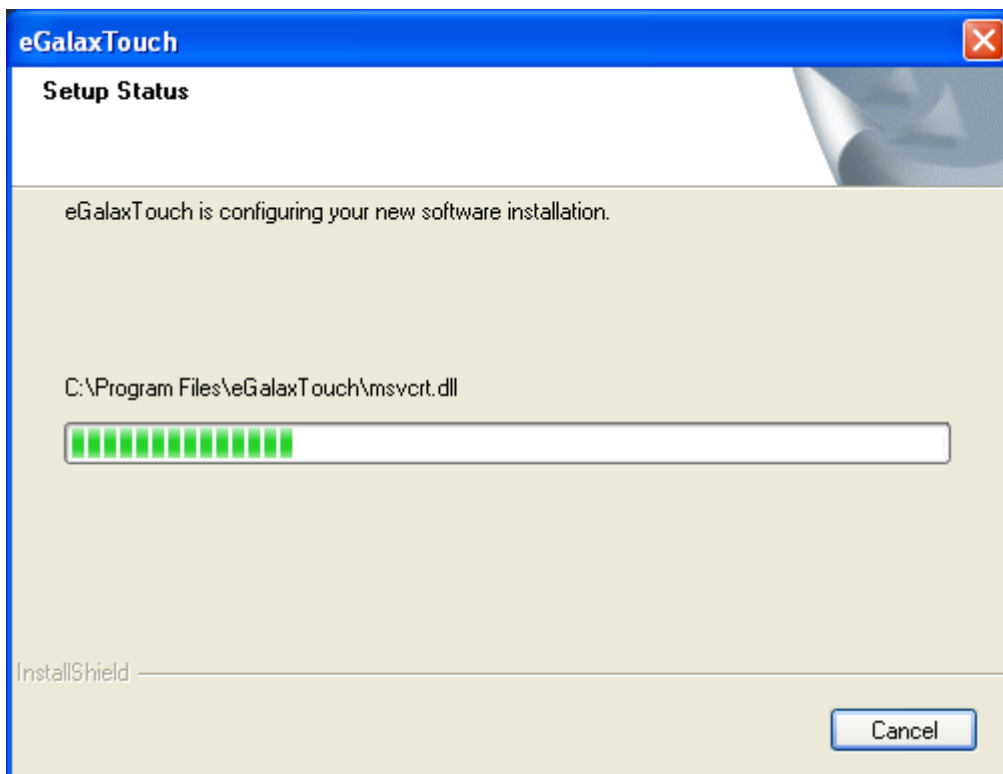

Step 13. Click **Yes** to do 4 point calibration.

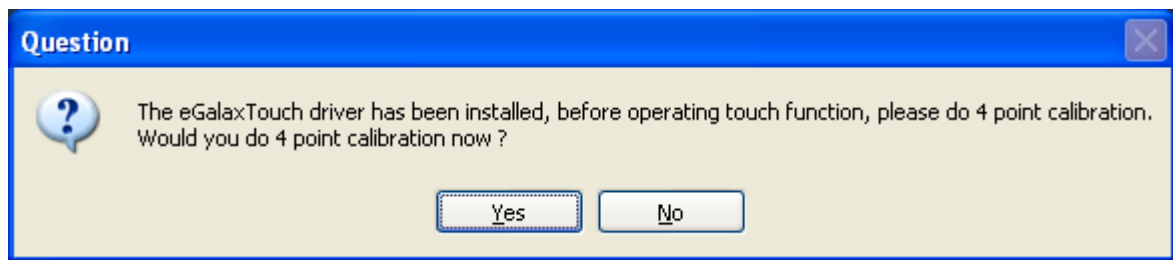

5.2 Software Functions

5.2.1 Software Functions (Resistive Touch)

Upon rebooting, the computer automatically finds the new 6000 controller board. The touch screen is connected but not calibrated. Follow the procedures below to carry out calibration.

1. After installation, click the PenMount Monitor icon "PM" in the menu bar.
2. When the PenMount Control Panel appears, select a device to "Calibrate."

PenMount Control Panel (Resistive Touch)

The functions of the PenMount Control Panel are **Device**, **Multiple Monitors**, **Tools** and **About**, which are explained in the following sections.

Device

In this window, you can find out that how many devices be detected on your system.

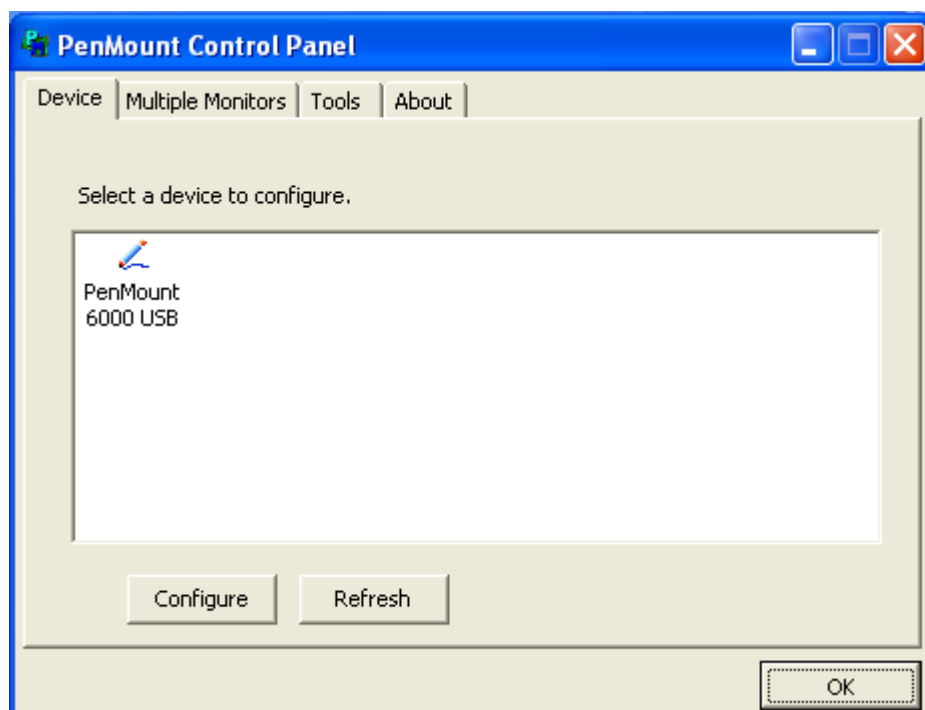

Calibrate

This function offers two ways to calibrate your touch screen. 'Standard Calibration' adjusts most touch screens. 'Advanced Calibration' adjusts aging touch screens.

Standard Calibration	Click this button and arrows appear pointing to red squares. Use your finger or stylus to touch the red squares in sequence. After the fifth red point calibration is complete. To skip, press 'ESC'.
Advanced Calibration	Advanced Calibration uses 4, 9, 16 or 25 points to effectively calibrate touch panel linearity of aged touch screens. Click this button and touch the red squares in sequence with a stylus. To skip, press ESC'.
Command Calibration	Command call calibration function. Use command mode call calibration function, this can uses Standard, 4, 9, 16 or 25 points to calibrate E.g. Please run ms-dos prompt or command prompt c:\Program Files\PenMount Universa Driver\Dmcctrl.exe -calibration 0 (Standard Calibration) Dmcctrl.exe - calibration (\$) 0= Standard Calibration 4=Advanced Calibration 4 9=Advanced Calibration 9 16=Advanced Calibration 16 25=Advanced Calibration 25

Step 1. Please select a device then click "Configure". You can also double click the device too.

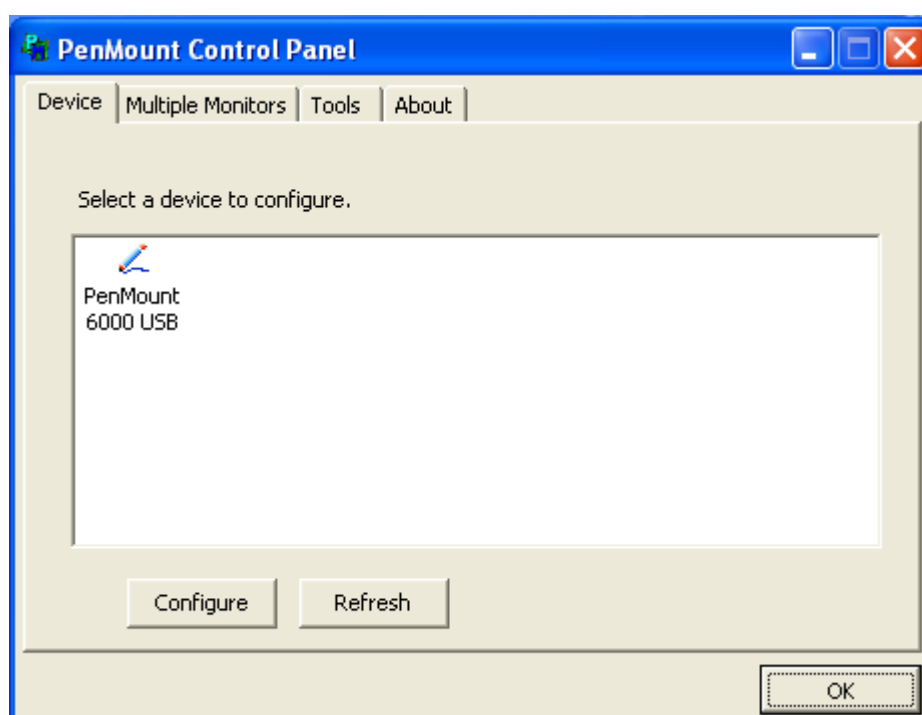

Step 2. Click "Standard Calibration" to start calibration procedure

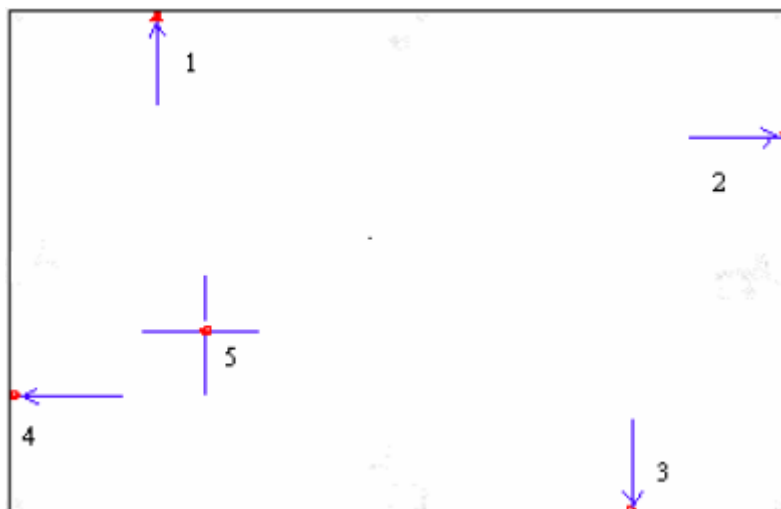

NOTE: The older the touch screen, the more Advanced Mode calibration points you need for an accurate calibration. Use a stylus during Advanced Calibration for greater accuracy. Please follow the step as below:

Step 3. Come back to “PenMount Control Panel” and select **Tools** then

click **Advanced Calibration**.

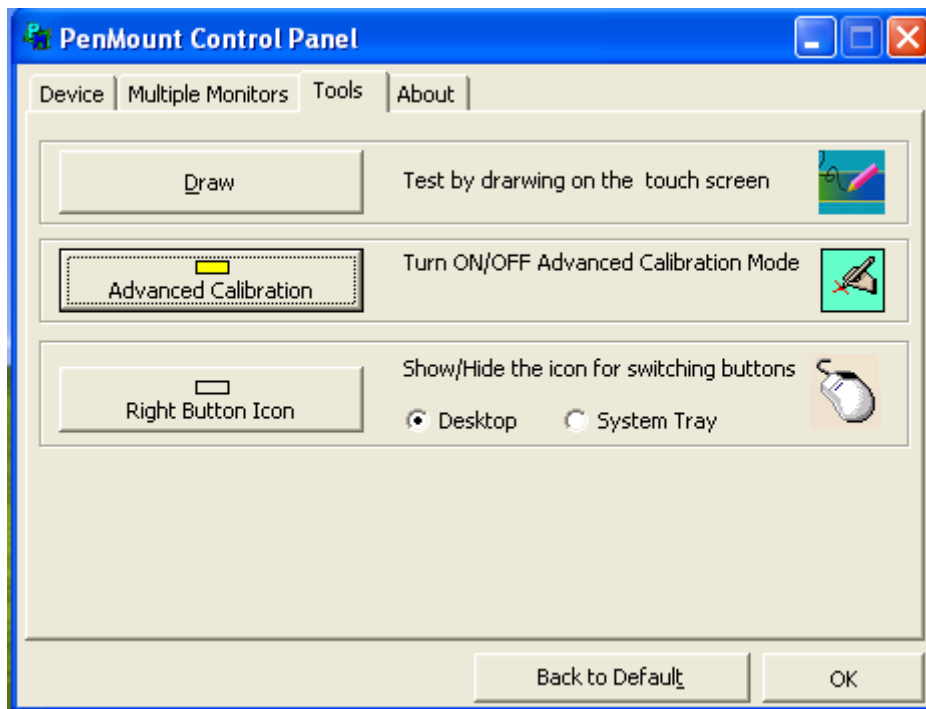

Step 4. Select **Device** to calibrate, then you can start to do **Advanced Calibration**.

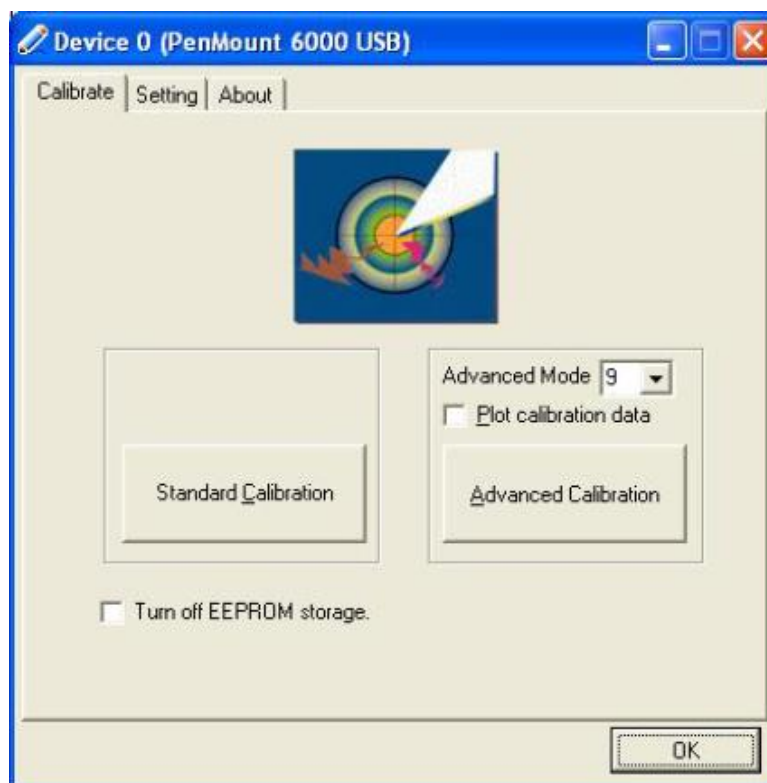

NOTE: Recommend to use a stylus during Advanced Calibration for greater accuracy.



Plot Calibration Data	Check this function and a touch panel linearity comparison graph appears when you have finished Advanced Calibration. The blue lines show linearity before calibration and black lines show linearity after calibration.
Turn off EEPROM storage	The function disable for calibration data to write in Controller. The default setting is enable.

Setting

Touch Mode	This mode enables and disables the mouse's ability to drag on-screen icons – useful for configuring POS terminals. Mouse Emulation – Select this mode and the mouse functions as normal and allows dragging of icons. Click on Touch – Select this mode and the mouse only provides a click function, and dragging is disabled.
Beep Sound	Enable Beep Sound – turns beep function on and off Beep on Pen Down – beep occurs when pen comes down Beep on Pen Up – beep occurs when pen is lifted up Beep on both – beep occurs when comes down and lifted up Beep Frequency – modifies sound frequency Beep Duration – modifies sound duration
Cursor Stabilizer	Enable the function support to prevent cursor shake
Use press and hold as right click	You can set the time out and area for you need.

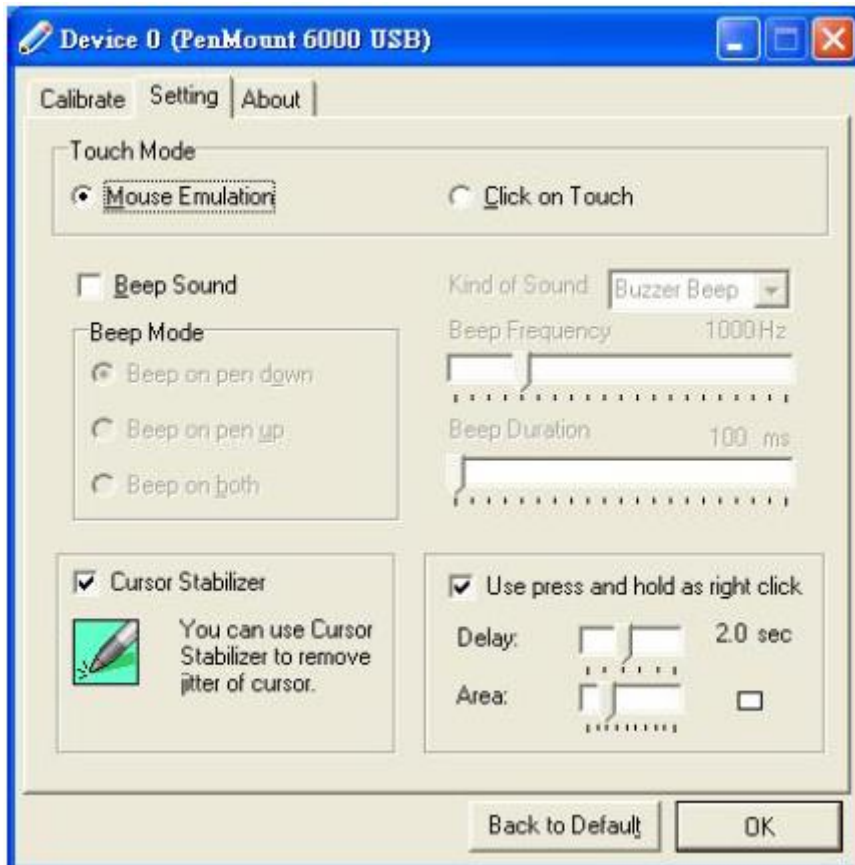

About

This panel displays information about the PenMount controller and driver version.

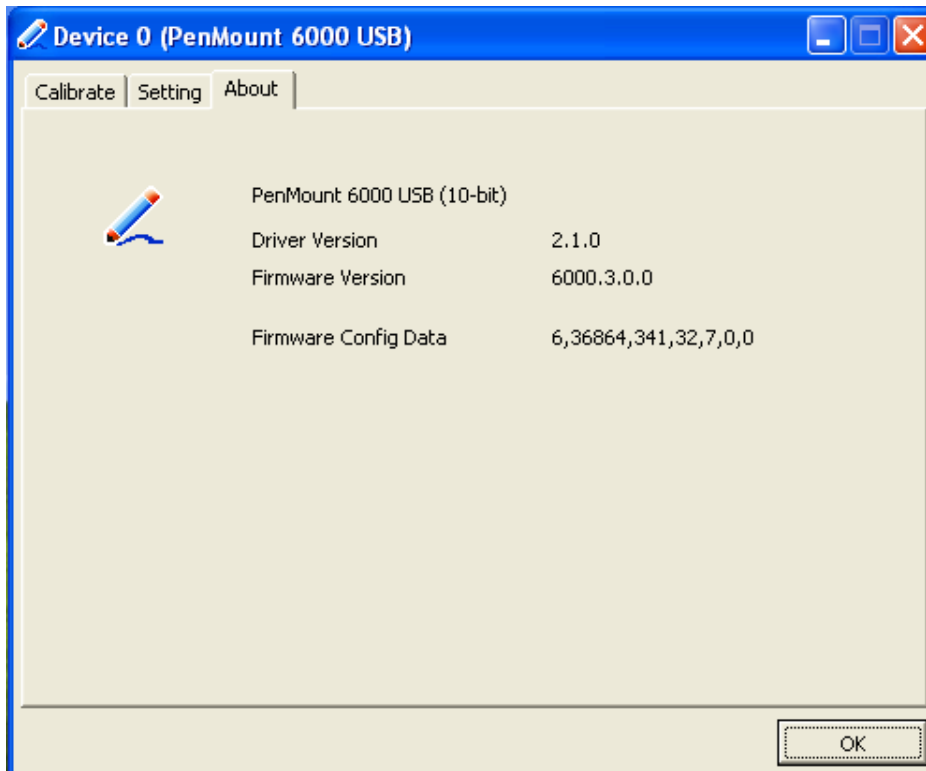

Multiple Monitors

Multiple Monitors support from two to six touch screen displays for one system. The PenMount drivers for Windows 2003/XP/Vista/7 support Multiple Monitors. This function supports from two to six touch screen displays for one system. Each monitor requires its own PenMount touch screen control board, either installed inside the display or in a central unit. The PenMount control boards must be connected to the computer COM ports via the RS-232 interface. Driver installation procedures are the same as for a single monitor. Multiple Monitors support the following modes:

Windows Extends Monitor Function
Matrox DualHead Multi-Screen Function
nVidia nView Function

NOTE: The Multiple Monitor function is for use with multiple displays only. Do not use this function if you have only one touch screen display. Please note once you turn on this function the rotating function is disabled.

Enable the multiple display function as follows:

1. Check the **Enable Multiple Monitor Support** box; then click **Map Touch Screens** to assign touch controllers to displays.

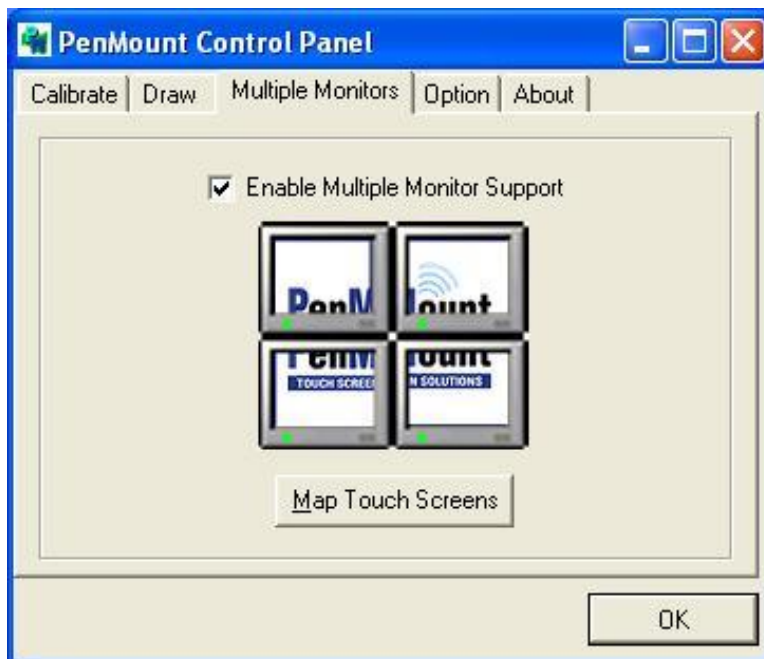

2. When the mapping screen message appears, click **OK**.

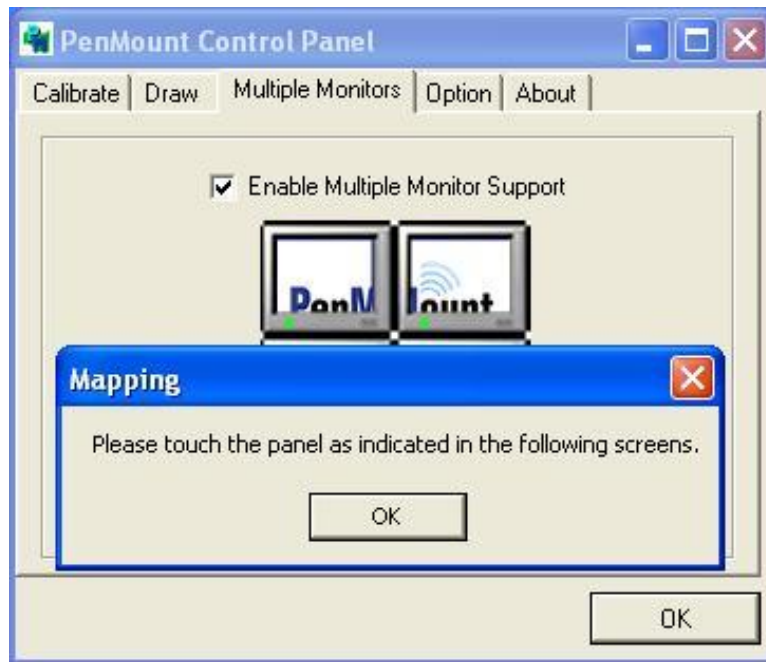

3. Touch each screen as it displays “Please touch this monitor”. Following this sequence and touching each screen is called **mapping the touch screens**.

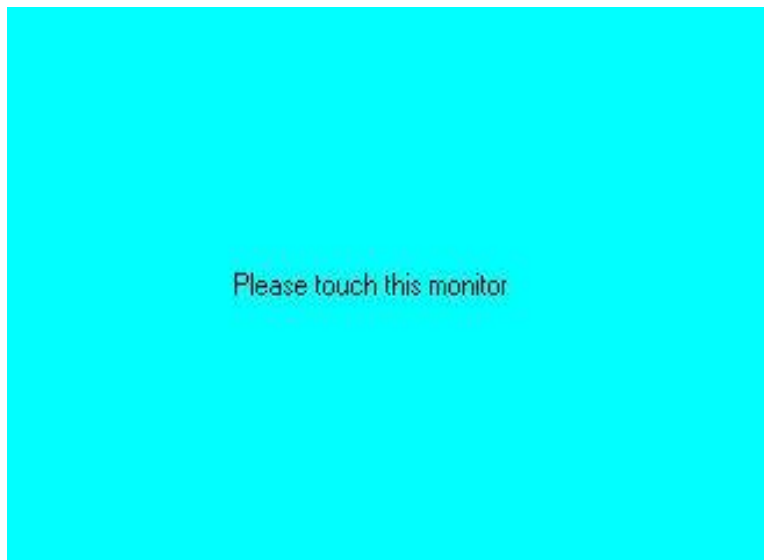

4. Touching all screens completes the mapping and the desktop reappears on the monitors.
5. Select a display and execute the “Calibration” function. A message to start calibration appears. Click **OK**.

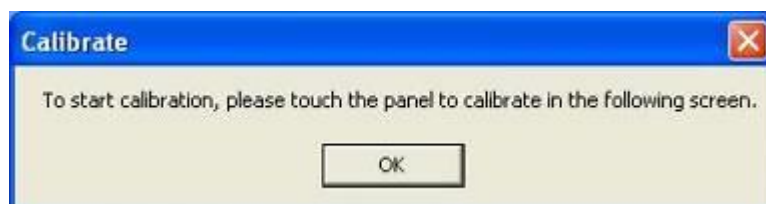

6. "Touch this screen to start its calibration" appears on one of the screens. Touch the screen.
7. "Touch the red square" messages appear. Touch the red squares in sequence.
8. Continue calibration for each monitor by clicking **Standard Calibration** and touching the red squares

NOTES:

1. If you use a single VGA output for multiple monitors, please do not use the **Multiple Monitor** function. Just follow the regular procedure for calibration on each of your desktop monitors.
2. The Rotating function is disabled if you use the Multiple Monitor function.
3. If you change the resolution of display or screen address, you have to redo **Map Touch Screens**, so the system understands where the displays are.

About

This panel displays information about the PenMount controller and this driver version.

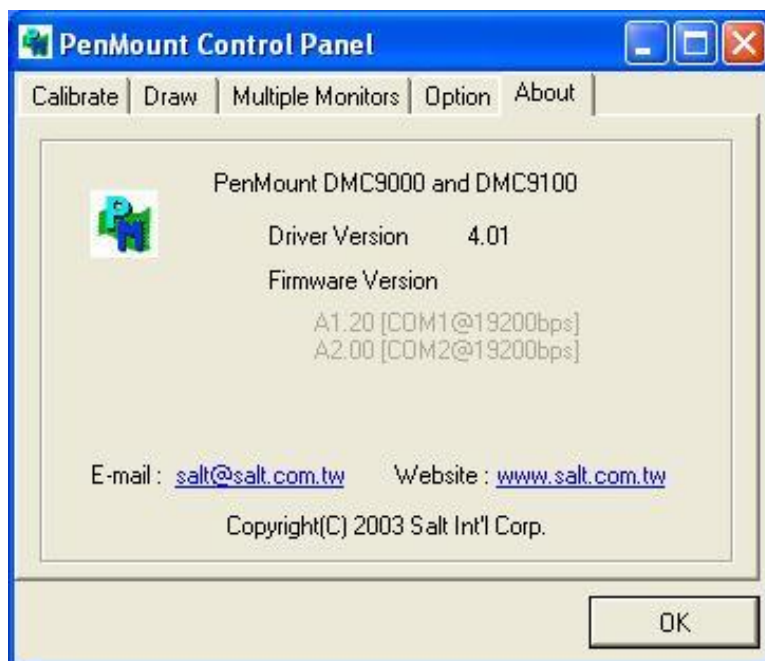

PenMount Monitor Menu Icon

The PenMount monitor icon (PM) appears in the menu bar of Windows 2003/XP/Vista/7 system when you turn on PenMount Monitor in PenMount Utilities.



PenMount Monitor has the following function



Control Panel	Open Control Panel Windows
Beep	Setting Beep function for each device
Right Button	When you select this function, a mouse icon appears in the right-bottom of the screen. Click this icon to switch between Right and Left Button functions. 
Exit	Exits the PenMount Monitor function.

PenMount Rotating Functions

The PenMount driver for Windows 2003/XP/Vista/7 supports several display rotating software packages.

Windows 2003/XP/Vista/7 support display rotating software packages such as:

- Portrait's Pivot Screen Rotation Software
- ATI Display Driver Rotate Function
- nVidia Display Driver Rotate Function
- SMI Display Driver Rotate Function
- Intel 845G/GE Display Driver Rotate Function

Configuring the Rotate Function

1. Install the rotation software package.
2. Choose the rotate function (0°, 90°, 180°, 270°) in the 3rd party software. The calibration screen appears automatically. Touch this point and rotation is mapped.

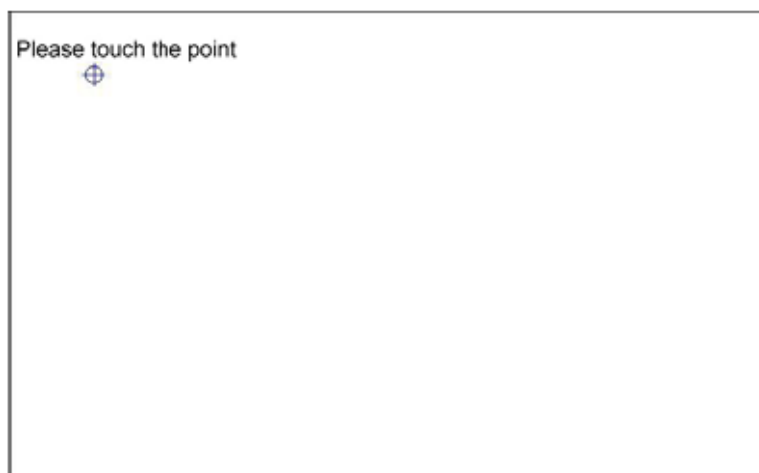

NOTE: The Rotate function is disabled if you use Monitor Mapping

5.2.2 Software Functions (Projected Capacitive)

General

In this window, you can see there is USB Controller. Click **OK** to continue.

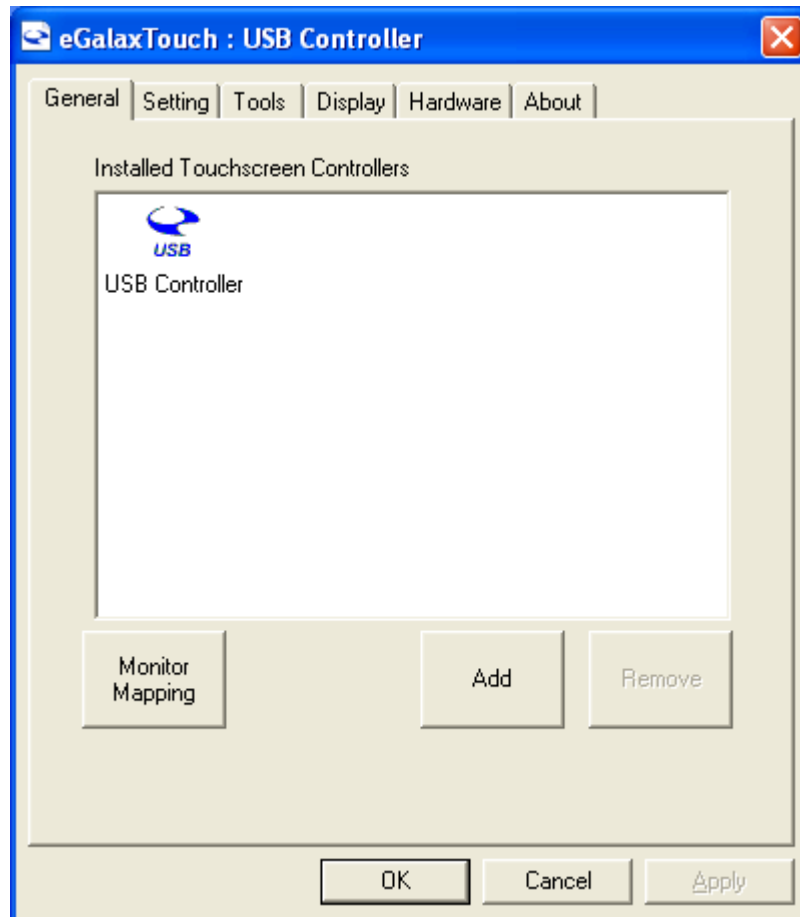

Monitor Mapping

To adjust touch panel

Add

To search for device

Setting

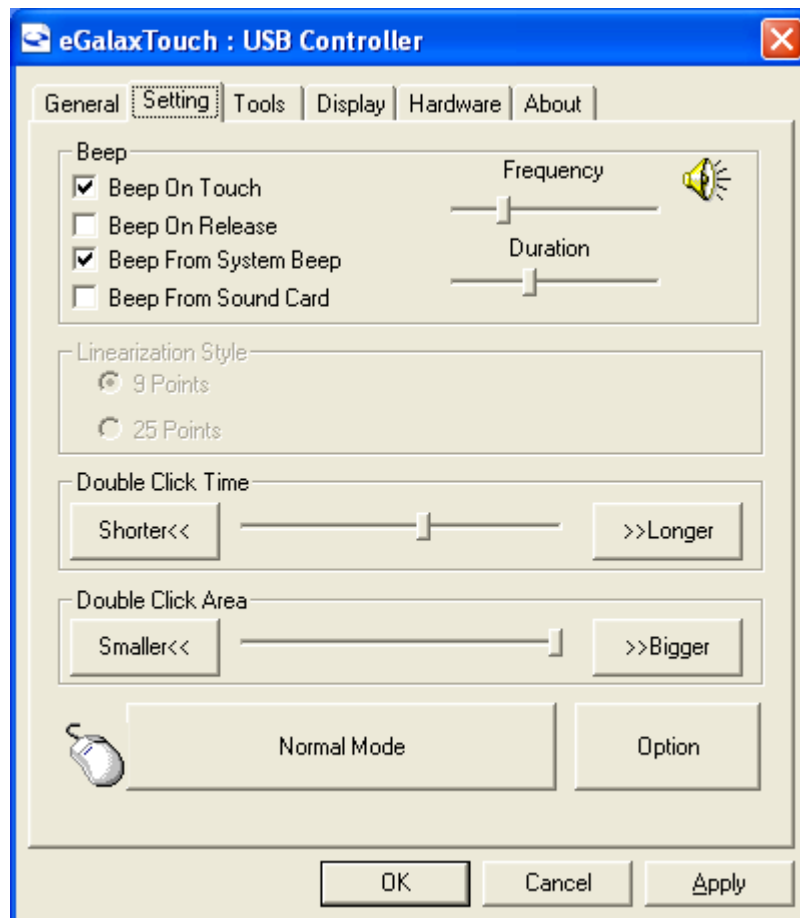

Beep

- Beep On Touch
- Beep On Release
- Beep From System Beep
- Beep From Sound Card

Linearization Style

- 9 points
- 25 points

Double Click Time

- Shorter
- Longer

Double Click Area

- Smaller
- Bigger

Normal mode

- Simulate the mouse mode

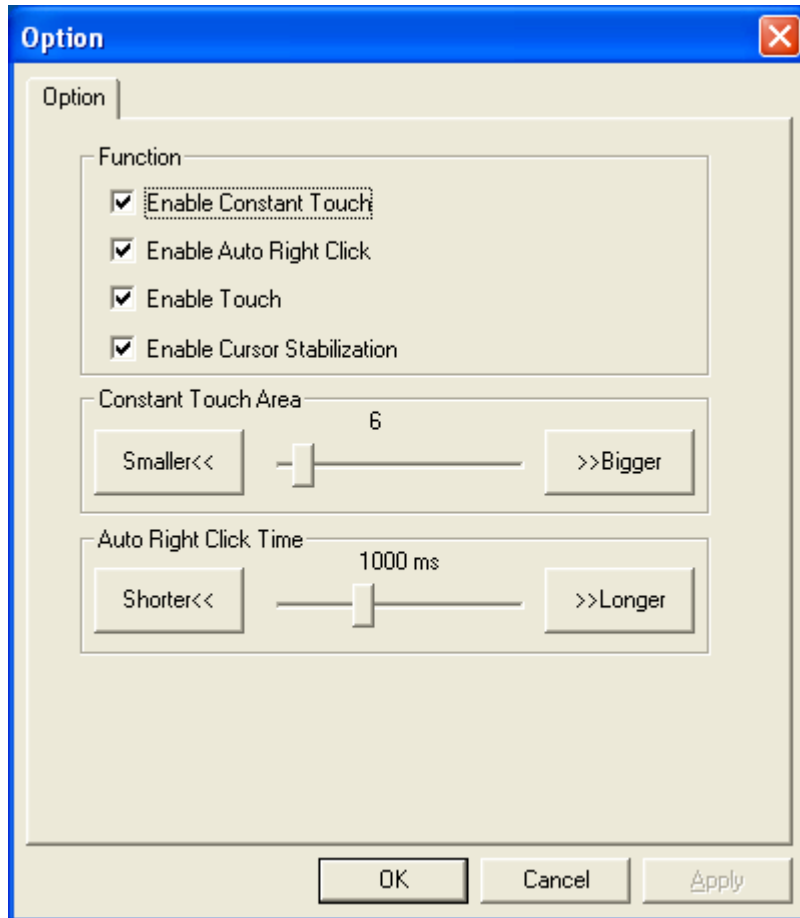

Option

Function

Enable Constant Touch

Enable Auto Right Click

Enable Touch

Enable Cursor Stabilization

Constant Touch Area

Auto Right Click Time

Tools

Click **OK** to continue the settings.

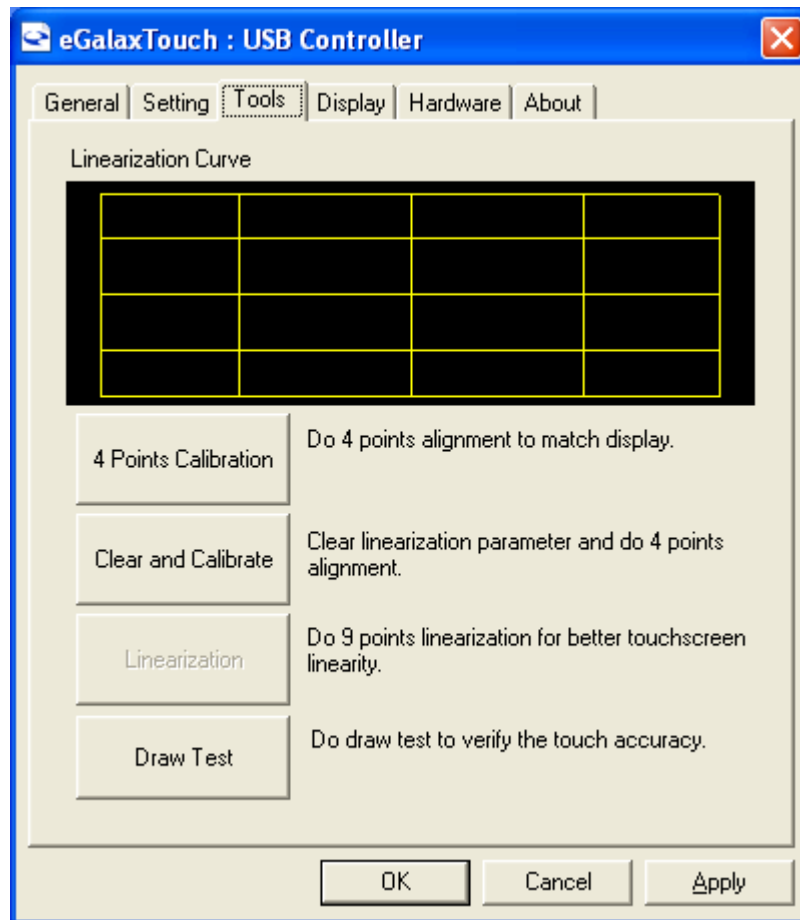

4 Points Calibration

Do 4 points alignment to match display.

Clear and Calibrate

Clear linearization parameter and do 4 points alignment.

Linearization

Do 9 points linearization for better touchscreen linearity.

Draw Test

Do draw test to verify the touch accuracy.

Display

In this window, it shows the mode of display.

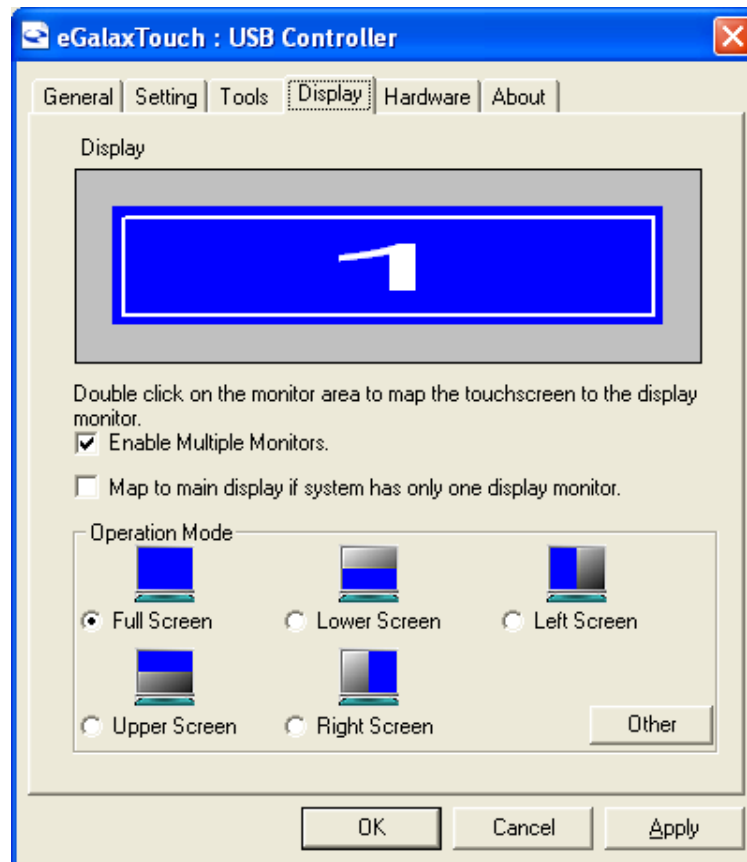

Enable Multiple Monitors.

Map to main display if system has only one display monitor

Full Screen

Lower Screen

Left Screen

Upper Screen

Right Screen

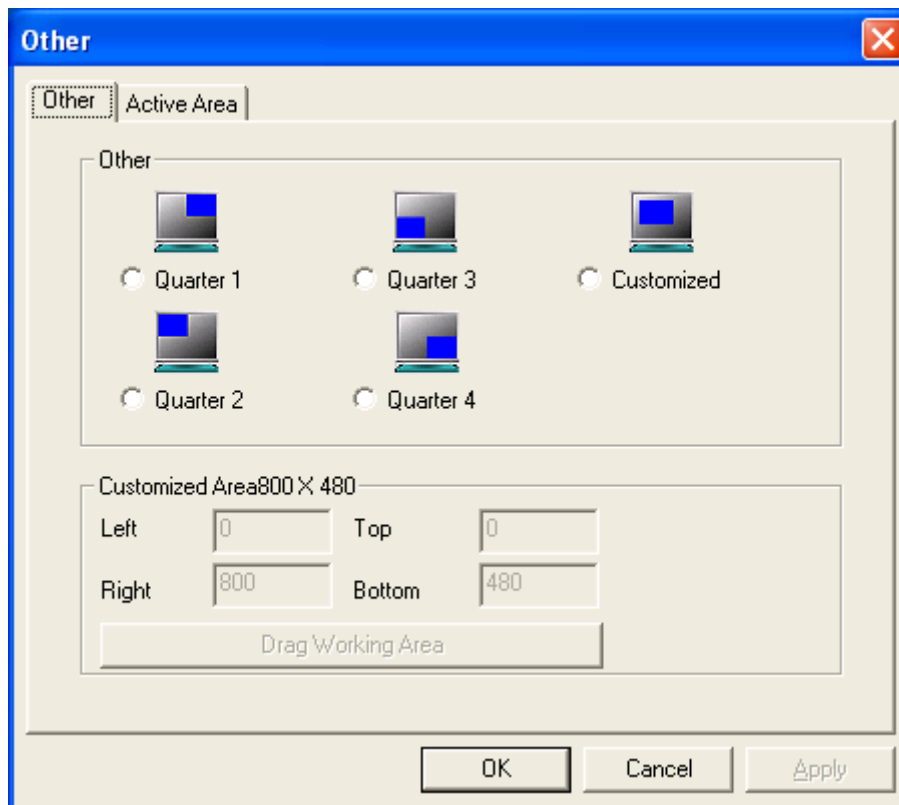

Other

Other mode of display. Quarter1~4 and Customized area.

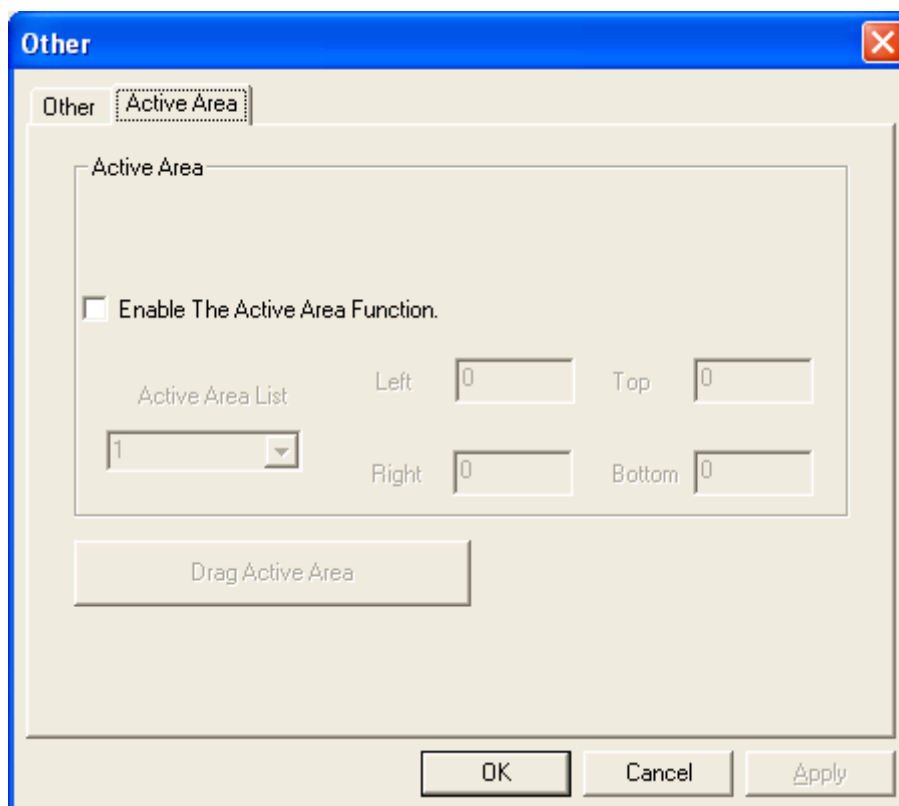

Active Area

Drag active area to enable Active Area Function.

Hardware

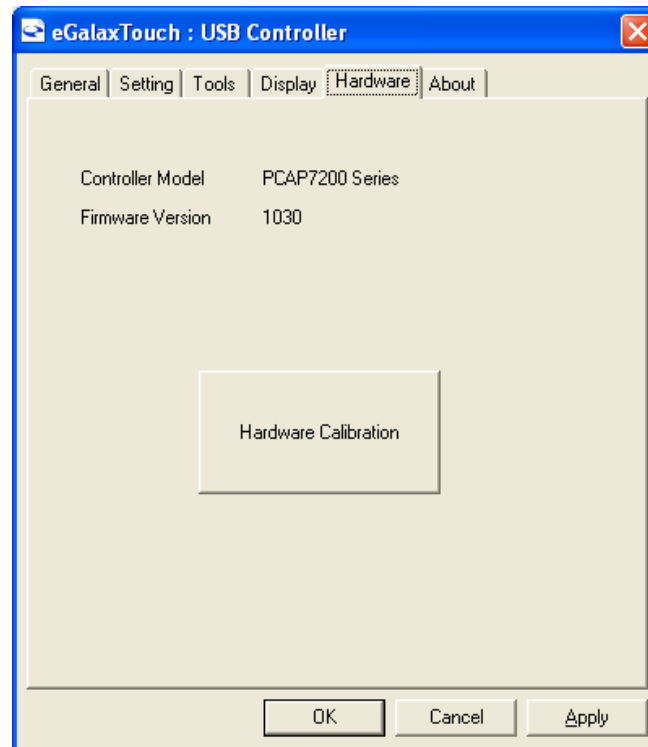

Saturn Hardware Configuration

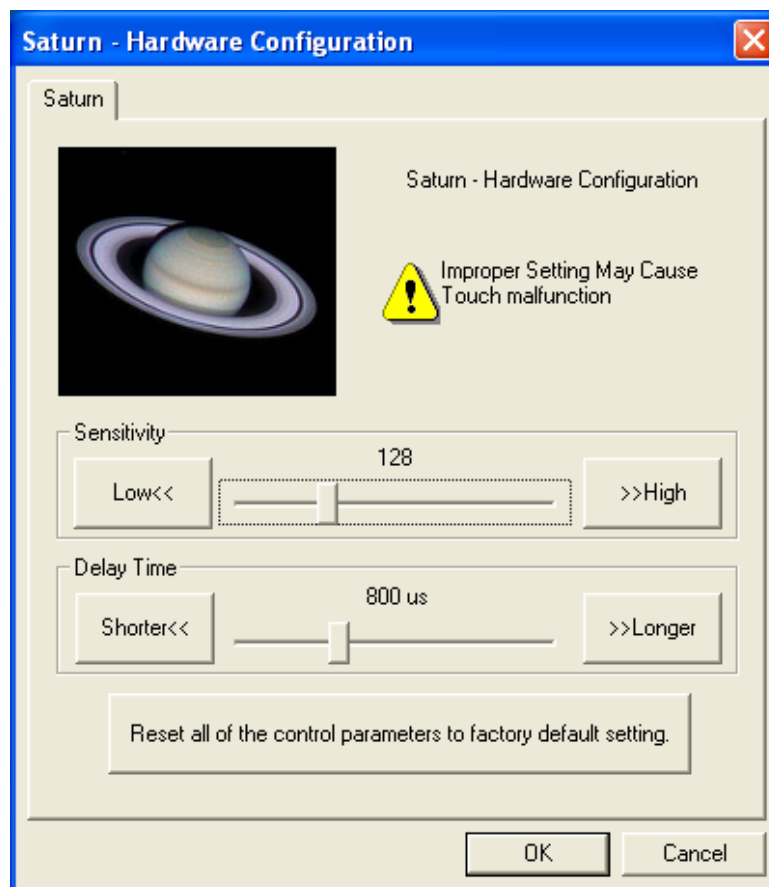

About

To display information about eGalaxTouch and its version.

